

ANALYSER OF 3-PHASE POWER NETWORK PARAMETERS ND1 TYPE



User's Manual



LZAE Lumel S.A.
Sulechowska 1
65-022 Zielona Góra
Poland (EU)

TABLE OF CONTENTS

<u>1. INTRODUCTION</u>	6
1.1. APPLICATION	6
1.2. ANALYZER FEATURES	6
1.3. FIRMWARE UPDATE	7
<u>2. GENERAL INFORMATION</u>	8
2.1. WARNING AND INFORMATION SIGNS	8
2.2. OPERATING SAFETY	8
2.2.1. REMARKS CONCERNING THE ANALYZER INSTALLATION	8
2.2.2. PRECAUTIONS IN THE ESD PROTECTION RANGE	10
<u>3. PREPARATION OF THE ND1 ANALYZER TO WORK</u>	11
3.1. UNPACKING	11
3.2. INSTALLATION IN THE PANEL	12
3.3. ANALYZER OPERATING CONDITIONS	12
<u>4. ANALYZER CONSTRUCTION</u>	13
4.1. LCD SCREEN WITH TOUCH PANEL	13
4.2. COMPACTFLASH MEMORY CARD, USB INTERFACE, LED DIODE	15
4.3. TERMINAL PLATE	16
4.3.1. MOUNTING OF THE POWER SUPPLY FILTER	17
4.3.2. ALARM CONNECTION, BINARY INPUTS AND ANALOG OUTPUTS	18
4.3.3. CONNECTION OF COMMUNICATION INTERFACES RS485(1) I RS485(2) INTERFACES	19
4.3.4. CONNECTION OF MEASURING SIGNALS	20
<u>5. GRAPHIC SIGNS ON THE ANALYZER SCREEN</u>	25
5.1.1. STATUS BAR	25
5.1.2. SERVICE MENU	25

5.1.3.	INFORMATION MESSAGES	26
5.1.4.	DIALOGS	26
5.2.	SIGNS AND COLORS OF MEASURING PARAMETERS	27
5.2.1.	GRAPHIC SIGNS	27
5.2.2.	COLORS OF MEASURING VALUES	28
<u>6.</u>	<u>ANALYZER START</u>	<u>29</u>
6.1.	CONTEXT MENU, BUTTON FUNCTIONS	29
6.2.	ENTRY TO PARAMETER CONFIGURATION, ND1 CONTROL PANEL WINDOW	31
<u>7.</u>	<u>CONFIGURATION OF ND1</u>	<u>33</u>
7.1.	GENERAL SETTINGS	34
7.1.1.	PARAMETER PROGRAMMING: BASIC	34
7.1.2.	PARAMETER PROGRAMMING: LCD SCREEN	35
7.1.3.	PARAMETER PROGRAMMING: COMPACTFLASH FORMAT	35
7.1.4.	PARAMETER PROGRAMMING: OTHER	36
7.2.	INPUTS	36
7.2.1.	PARAMETER: GENERAL	36
7.2.2.	PARAMETER: AVERAGE	37
7.2.3.	PARAMETER PROGRAMMING: TARIFFS	38
7.2.4.	PARAMETER PROGRAMMING: LOGS	38
7.3.	ALARMS	39
7.3.1.	PARAMETER PROGRAMMING: GENERAL	39
7.3.2.	PARAMETER PROGRAMMING: CONTROL	43
7.4.	ANALOG OUTPUTS	45
7.4.1.	SELECTION OF THE ANALOG OUTPUT	45
7.4.2.	PARAMETER PROGRAMMING: GENERAL	45
7.4.3.	PARAMETER PROGRAMMING: RANGE	46
7.5.	POWER QUALITY	47
7.5.1.	PARAMETER PROGRAMMING: GENERAL	47
7.5.2.	PARAMETER PROGRAMMING: DIPS	48
7.6.	VISUALIZATION	50

7.6.1.	PARAMETER: GENERAL	50
7.6.2.	PARAMETER: SCREENS	51
7.6.3.	PARAMETER PROGRAMMING: RANGES	57
7.6.4.	PARAMETER PROGRAMMING: LOGS	57
7.6.5.	PARAMETER PROGRAMMING: OTHER (AUTO-VIEWS)	58
7.7.	ARCHIVIZATION	59
7.7.1.	PROGRAMMING OF GROUP PARAMETERS	60
7.8.	ETHERNET	62
7.9.	MODBUS	63
7.9.1.	CONFIGURATION OF MODBUS MASTER	63
7.9.2.	CONFIGURATION OF CII..24 INTERFACE INPUTS (GENERAL AND REGISTER)	64
7.9.3.	CONFIGURATION OF MODUS SLAVE	65
7.10.	SECURITY	65
7.11.	SYSTEM INFORMATION	67
7.12.	FILE BROWSER	68
7.13.	EVENTS LOGS	68
7.13.1.	BROWSING AND HANDLING OF EVENT LOGS	70
7.14.	EDITION OF USER'S MESSAGES	72
7.15.	EXIT FROM THE ANALYZER CONFIGURATION	74
8.	<u>SELECTED ELEMENTS FROM THE CURRENT ANALYZER OPERATION</u>	<u>75</u>
8.1.	COMPACTFLASH MEMORY CARD	75
8.1.1.	INFORMATION ABOUT CF CARD	75
8.1.2.	FORMATTING THE CF CARD	75
8.1.3.	DATA STORAGE ON THE CF CARD	76
8.1.4.	VISUALIZATION ON THE CF CARD STATE ON SCREENS	78
8.1.5.	BROWSING AND ERASING OF FILES FROM THE CF CARD	79
8.1.6.	REMOVING CF CARD, EXCHANGE OF CF CARDS, WRITE OF ARCHIVE DATA	80
8.2.	TOUCH SCREEN CALIBRATION	81
8.3.	UPDATING THE ANALYZER PROGRAM	82
8.4.	MAINTAINING DATA STORED ON THE CF CARD, VISUALIZATION	83

<u>9. PROGRAMS ON THE PC</u>	<u>85</u>
9.1. KD CONNECT PROGRAM	85
9.1.1. INSTALLATION OF THE USB DRIVER	85
9.2. ND1 SETUP APPLICATION	86
9.3. KD CHECK APPLICATION	86
<u>10. TECHNICAL DATA</u>	<u>87</u>
<u>11. ORDER CODES</u>	<u>92</u>
<u>MAINTENANCE AND GUARANTEE</u>	<u>93</u>

1. Introduction

1.1. Application

The ND1 Power Quality Analyzer is destined for the measurement and analysis of 3-phase, 3 or 4-wire power network parameters, in balanced or unbalanced systems.

1.2. Analyzer Features

Following features characterize the ND1 Power Quality Analyzer:

- Measurement and recording of electrical energy quality parameters in accordance with the EN 50160 standard and more than 300 other parameters of 3-phase power networks
- LCD TFT 5.7" color screen, 320 x 240 pixels, with a touch panel for the analyzer service.
- Intuitive operating by means of the touch screen and graphic user's friendly interface based on the MS Windows.
- Exchangeable CompactFlash external memory with capacity up to 4 GB.
- Communication interfaces: Ethernet 10 Base-T, Modbus TCP/IP Slave, USB 1.1 Device, RS-485 Modbus Master, RS-485 Modbus Slave.
- Analog outputs, alarms, binary inputs.
- Storage of data in the internal 6 MB buffer with data support (for before and after damage states).
- Alarm, Audit, Energy, Power Quality, Dips and Swells and Statistics logs.
- Dedicated visualization in form of displays: digital, analog, bargraphs, harmonics, vector diagram, statistics, binary inputs.
- Context help in the user's configuration menu and in the measuring mode.
- Menu languages: English and Polish.
- Programmable events controlled by binary inputs.
- Programmable alarms.
- Selection of the time zone, automatic change of summer/winter time, synchronization with a time server (NTP).
- IP65 protection grade from the user's side.

Diversity of applications:

- Monitoring of energy quality (data acquisition).
- Load measurement, network optimization.
- Harmonic analysis up to the 51 st.
- Decays, dips, asymmetry.
- Inspection of compensation effectiveness.

1.3. Firmware Update





The manufacturer reserves the right to a continuous improvement and makes changes in design and specifications in the product without warning. This especially concerns the internal device software (so called device **firmware**). The current software version and other files destined for the analyzer are available at our web page:

<http://www.lumel.com.pl>

2. General Information

2.1. Warning and Information Signs

One or more of presented symbols can be used in the user's manual:

	Caution: pay special attention to the description in the analyzer user's manual.
	Terminal of the protection lead
	Earth terminal
	Protection of sensitive electrostatic systems (ESD)

2.2. Operating Safety

In the safety operating scope, the ND1 Power Analyzer meets requirements related to safety of electrical measuring instruments for automation, acc. to EN 61010-1 standard and requirements concerning the immunity against noises occurring in industrial environments acc. to EN 61000-6-2 and EN 61000-6-4 standards.

The improper connection of the supply, communication interfaces and measuring signals, and the use of equipment inconsistent with the description included in the present user's manual and standards as above, can cause serious damage of the analyzer.

2.2.1. Remarks Concerning the Analyzer Installation

Various sources of noise occurring in practice interact with the ND1 Power Analyzer in a continuous or pulse way from the supply network side (as the result of the action of other devices) and also overlap on the measured signal or auxiliary circuits of the analyzer. Noises occur also when switching capacitive-inductive loads by own analyzer alarm relays.

In particular, strong pulse noises are dangerous for the device operation since they can cause sporadic erroneous measurement results or accidental operations of alarms. The level of these noises should be reduced to a value lower than the immunity threshold of the analyzer, first of all through a suitable installation of the analyzer in the object.

In this scope, it is recommended to observe following recommendations:

- Do not supply the analyzer from networks near devices generating high pulse noises in the supply network and do not use common grounding circuits with them.
- Signaling wires must be shielded.
- Lead connections of binary input circuits, individually in shields as above, by means of twisted wires.
- Connections of communication interface circuits, lead individually in shields as above and by means of twisted wires.
- All shields should be earthed unilaterally near the analyzer.
- A common earth conductor with other devices must be avoided.
- Apply the general principle that wires (group of wires) leading different signals should be led in the longest possible distance between them and crossings of such groups of wires should be made at a 90° angle.
- When connecting the supply, please remember that a switch or a circuit-breaker should be installed in the room. This switch should be located near the analyzer, easy accessible by the operator and suitably marked as an element switching the analyzer off.
- It is not allowed to remove the analyzer casing.
- All operations concerning transport, installation, and commissioning as well as maintenance, must be carried out by qualified, skilled personnel, and national regulations for the prevention of accidents must be observed.
- Protections ensuring the device safety can be less effective in case of exploitation inconsistent with manufacturer's indications and principles of a good engineering practice.

2.2.2. Precautions in the ESD Protection Range



Semiconductor elements or packages used in the analyzer design and marked with the sign as above, can be damaged in result of electrostatic discharges (ESD).

In order to prevent this, you must observe following recommendations during service works:

- Disassemble instruments only in the area protected against electrostatic discharges.
- Use conductive materials to dissipate electrostatic charges in the working area.
- Use only antielectrostatic packings to store electronic elements and packages.
- Do not touch elements and packages with hands.
- Do not keep materials susceptible to generate electrostatic charges in the working area.

Repairs and modifications in the device equipment should be carried out by authorized service workshops or with the manufacturer.



3. Preparation of the ND1 Analyzer to Work

The analyzer with accessories is delivered in packing fulfilling requirements of environment protection regulations.

The analyzer in the shipping packing can be transported and stored in the temperature -20+65°C (-4 ...149°F).

3.1. Unpacking

A. Take the ND1 analyzer out from the shipping packing.

The data plate with the version code, factory number and supply parameters are placed on the analyzer casing. Before unpacking, check the conformity of the device version with the order.

B. Take ND1 analyzer accessories out from the transport packing.

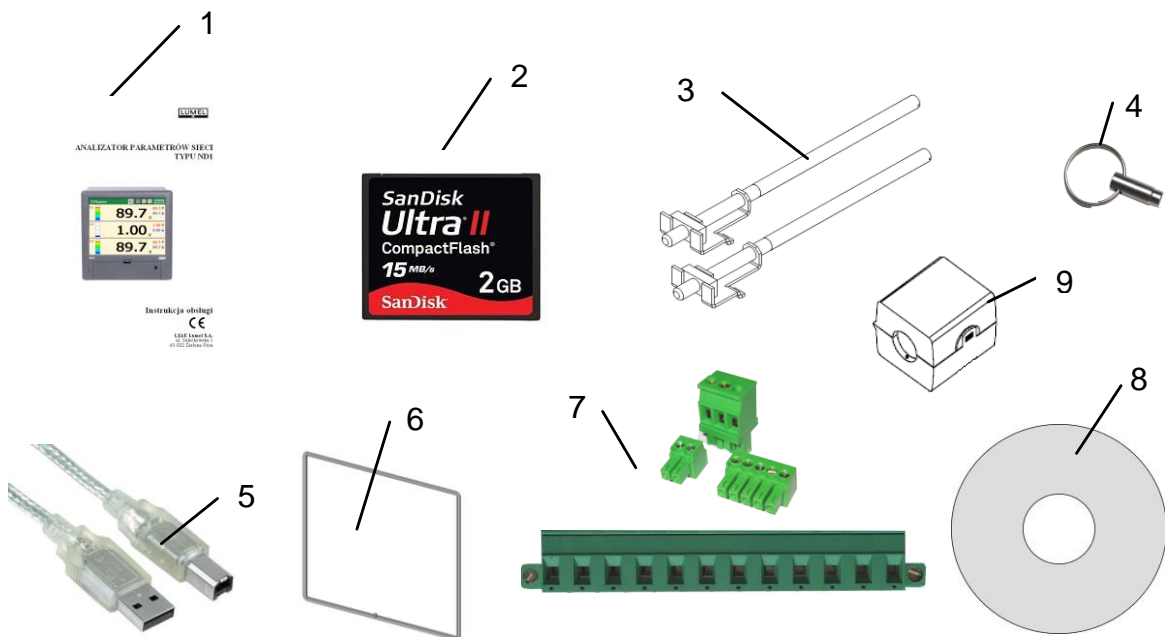

1.	User's manual (quick start)	1 pc
2.	CF memory card	1 pc
3.	Mounting brackets	4 pcs
4.	Key	2 pcs
5.	USB cable 1.8m (shielded)	1 pc
6.	Seal (ND1 casing- panel)	1 pc

7.	Set of plugs	1 set
8.	CD with software and manuals	1 pc
9.	Power supply filter	1 pc
	Guarantee card	1 pc

Note: Before unpacking the memory card carry away electrostatic charges from the body.

3.2. Installation in the Panel

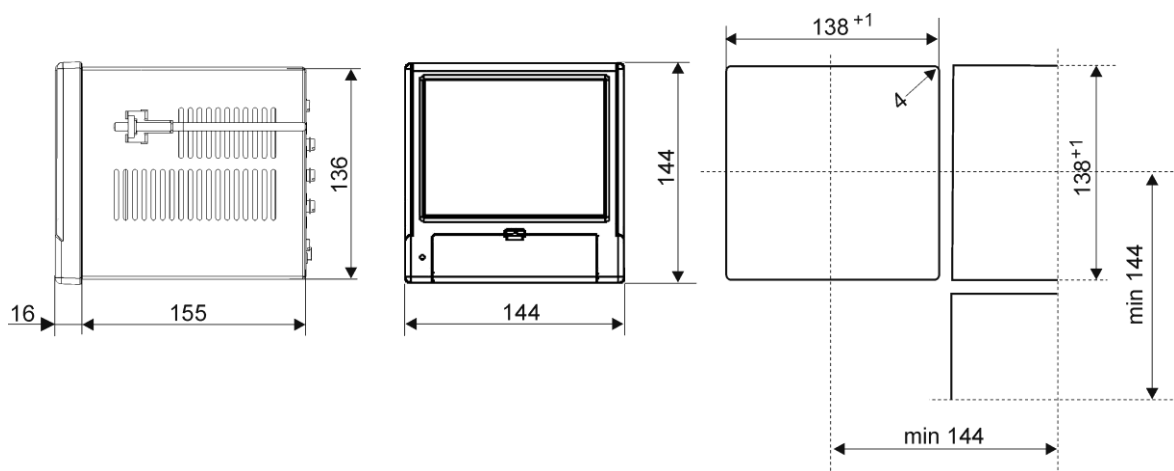

Fig. 3.1. Analyzer installation in the panel

Put the seal from standard accessories on the casing (see section 3.1). After mounting the analyzer into the panel, the seal protects the part behind the panel against the influence of risks appearing from the frontal part of the panel, resulting from the IP65 protection grade. The analyzer is fixed to the panel by means of four screwed mounting brackets from the standard accessory set (see section 3.1.). Basic fixing and panel cut-out dimensions are presented on the above figure.

3.3. Analyzer Operating Conditions

The analyzer can work at ambient temperature: 0...+50°C (32 ...122°F) and max.75% of relative air humidity without condensation (or at 0...+65°C and max. 40% RH without condensation).

4. Analyzer Construction

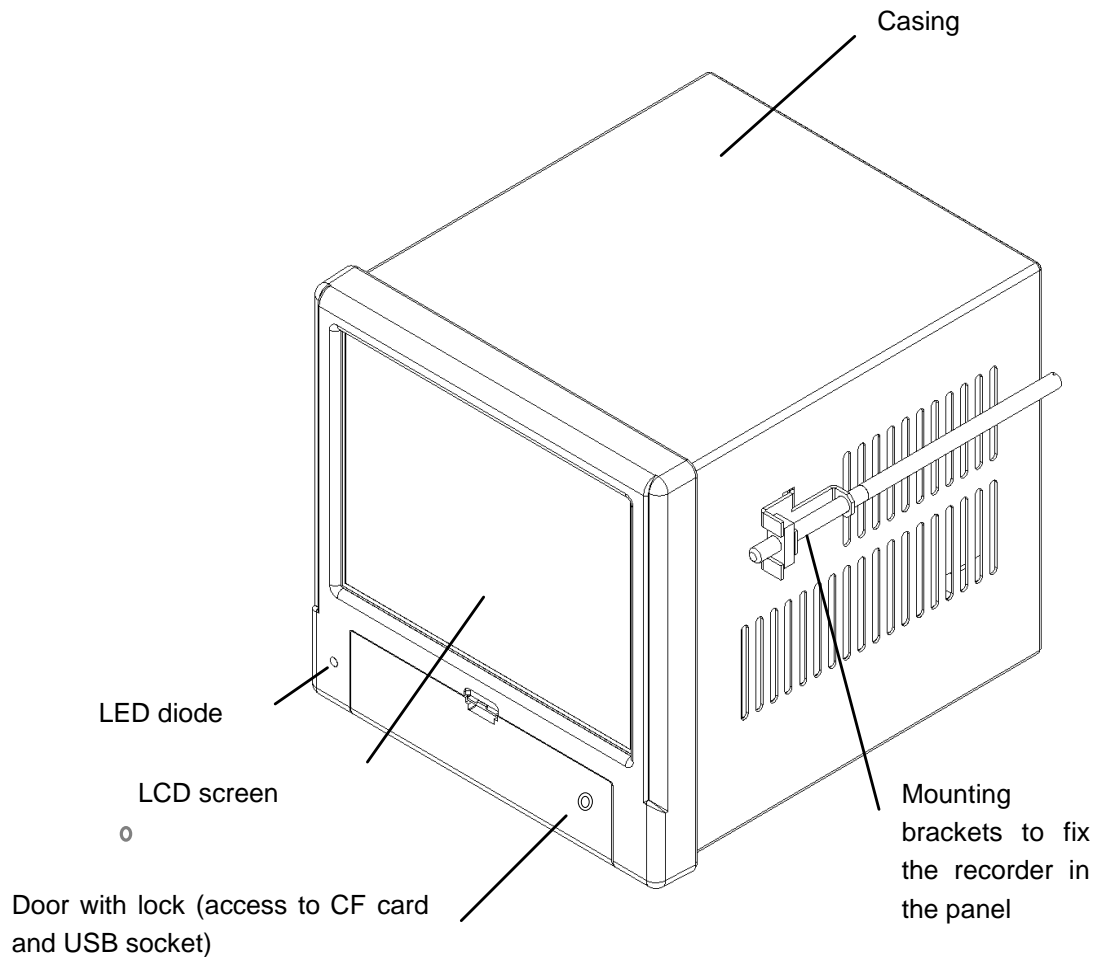

Fig. 4.1. Analyzer construction

4.1. LCD Screen with Touch Panel

For the visualization of measuring data and the configuration of analyzer parameters, an LCD TFT 5.7" graphical screen integrated with a touch panel is applied (Fig. 4.2).

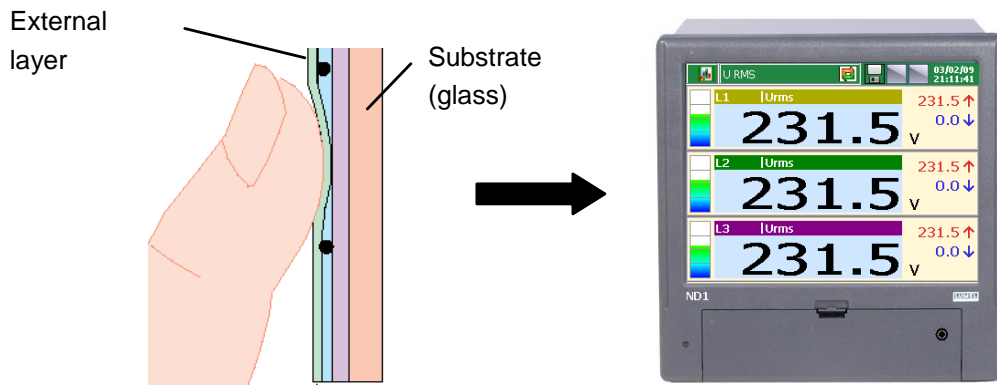

Fig. 4.2. Touch screen

All elements of the user's interface (windows, icons, buttons) have dimensions adapted to be easily handled by fingers – They do not require special tools.

After mounting the analyzer into the panel, remove the foil protecting the external flexible layer of the touch panel if exist.

Considering the sensibility of the touch panel to dirt and external damages of its surface and the substrate, observe the following recommendations:

- protect against impacts, they can damage the external surface or the glass substrate of the touch panel,
- protect against fluids, grease and aggressive chemical agents,
- touch the screen with fingers only, do not use hard and sharp objects which can damage the flexible surface of the touch panel,
- clean softly with a cotton cloth impregnated with a detergent destined to clean LCD monitors (not containing alcohol, petrol or ammonia) or by using water with soap,
- observe the given temperature range of the analyzer operation.

Since there is a possibility of an image persistence effect on an LCD screen (after a **prolonged** display of a constant figure), as default the screensaver (the blank screen) is set for 15-minute timeout (after continuous work without touching the screen). The screensaver is gone when the screen is touched any place. The timeout can be changed or this function can be switched off completely (see section 7.1.2.).

4.2. CompactFlash Memory Card, USB Interface, LED Diode

A CompactFlash card with capacity up to 4 GB is dedicated to a measuring data support. It is recommended to apply CF cards produced by SanDisk® company. Current measuring data, archive data and analyzer configuration files are stored on the CF card

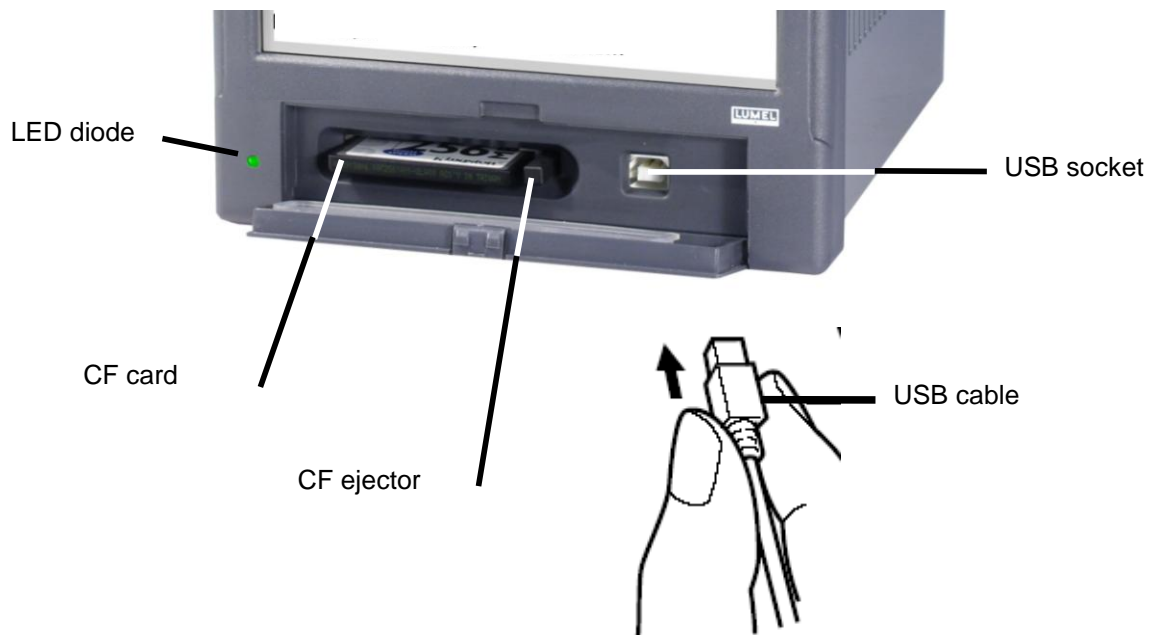



Fig. 4.3. Frontal view of the analyzer after opening the door

You can download data from the CF card to a PC through the USB interface. You can also save or delete selected files on the card. To connect the computer to the analyzer through the USB socket, use the shielded USB AM-BM cable of 1.8 m long (delivered in standard accessories) or another similar of maximum 3 m long.



To gain access to the ND1 analyzer data thru USB interface on a PC with MS Windows operating system it is necessary to install drivers and the KD Connect program from the accompanied CD. It is delivered with the analyzer accessories (for the description and program installation, see section 9.1).

The LED diode placed on the left side of the door signals the analyzer operating state:

Green color of the diode	the analyzer is set working, normal operating state	
Red color of the diode	signals the storage of data on the CompactFlash memory card. In this operating state, you must not take out the card from the seat risk to lose measuring data!	

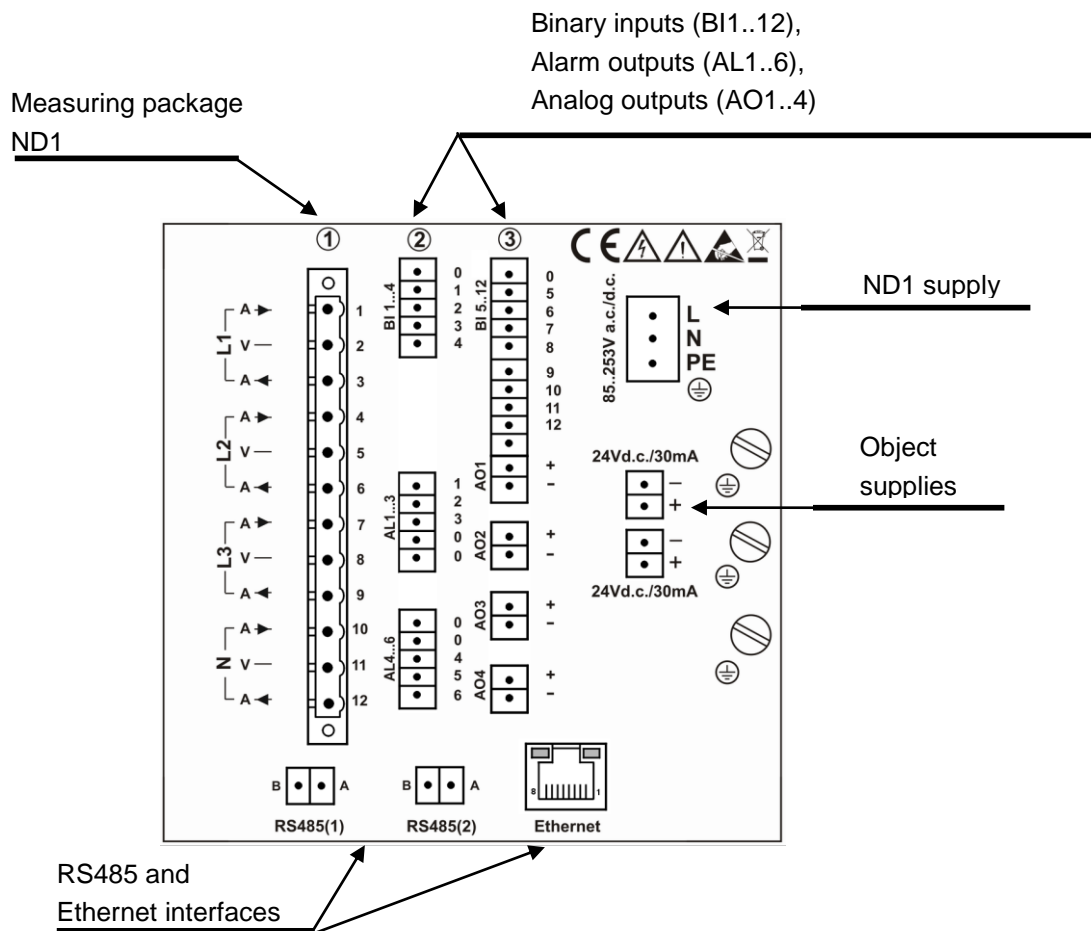
4.3. Terminal Plate



Symbol of terminal group	Terminal description
1	Connection sockets of the measuring package (L1, L2, L3, N) Measured quantity: – current: 1 A or 5 A, – voltage: 57.7 V a.c. / 100 V a.c. or 230 V a.c. / 400 V a.c. or 400 V a.c. / 690 V a.c.
2 and 3	Connection sockets: Alarms (AL 1..6) - 6 relays NO Binary inputs (BI 1..12) – 12 inputs Analog outputs (AO 1..4) – 4 outputs
L, N, PE 	Connection sockets of the supply voltage: 85..230..253 V a.c./d.c.
24 V d.c. / 30 mA	Auxiliary supplies destined to supply external systems
RS485(1), RS485(2), Ethernet	Communication interfaces: RS485 Modbus Master, RS485 Modbus Slave, Ethernet 10-Base-T
	Earthing functional terminals to connect screens

4.3.1. Mounting of the Power Supply Filter

In order to fulfill EMC requirements, one must always apply the delivered power supply filter when connecting the supplying wire to the analyser.

To mount the power supply filter one must reeve all the three supplying wires (L,N,PE) through the filter core, creating a full loop around it (Fig.4.4).



Fig. 4.4. Connection of the power supply filter.

4.3.2. Alarm Connection, Binary Inputs and Analog Outputs

Connection to terminals of the alarm system (electromechanical relays) AL1..6

	<p>Alarms are normally open contacts (NO). Parameters of the alarm system are given in the chapter "Technical Data".</p>
--	---------------------------------------------------------------------------------------------------------------------------------

Connection of the control signal to terminals of the binary input system BI1..12

	<p>Binary inputs BI1..12 are controlled by the signal: 0 V d.c. – inactive binary input <i>or</i> +5...24 V d.c. – active binary input</p>
--	-----------------------------------------------------------------------------------------------------------------------------------------------------------------------------

Connection to the analog output system AO1..4

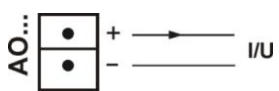
	<p>Parameters of analog output signals AO1..4 are given in the chapter “Technical Data”.</p>
-----------------------------------------------------------------------------------	------------------------------------------------------------------------------------------------------------

4.3.3. Connection of communication interfaces RS485(1) i RS485(2) interfaces

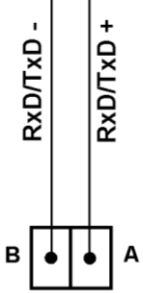
	<p>Parameters of interfaces RS485(1) Master and RS485(2) Slave are given in the chapter “Technical Data”</p>
-----------------------------------------------------------------------------------	---------------------------------------------------------------------------------------------------------------------

Interface Ethernet 10-Base-T

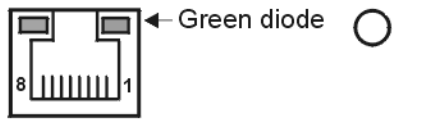
<p>Ethernet 10-BASE-T Socket RJ45:</p> <table border="0"> <tr> <td>1 - Tx+</td> <td>5 - nc</td> </tr> <tr> <td>2 - Tx-</td> <td>6 - Rx-</td> </tr> <tr> <td>3 - Rx+</td> <td>7 - nc</td> </tr> <tr> <td>4 - nc</td> <td>8 - nc</td> </tr> </table>  <p>Ethernet</p>	1 - Tx+	5 - nc	2 - Tx-	6 - Rx-	3 - Rx+	7 - nc	4 - nc	8 - nc	<p>Description of Ethernet socket diodes:</p> <p>Yellow diode: lights when the analyzer is connected to the Ethernet network and does not light otherwise.</p> <p>Green diode: Tx/Rx, lights irregularly when the analyzer uploads and collects data from the network and lights.</p>
1 - Tx+	5 - nc								
2 - Tx-	6 - Rx-								
3 - Rx+	7 - nc								
4 - nc	8 - nc								

Lead functions of the **RJ45** socket are in compliance with the EIA/TIA 568A/B (AT&T258) standard. To connect the analyzer with the **hub** (concentrator) or the **switch**, you have to use a cable with leads 1:1, according to the description as in the above figure. To the direct **ND1** connection with the **PC**, use a crossed cable:

ND1		PC	
Tx +	1	3	Rx +
Tx -	2	6	Rx -
Rx +	3	1	Tx +
Rx -	6	2	Tx -

Note: The cable length cannot exceed 100 meters.

4.3.4. Connection of Measuring Signals

Note:



1. To connect measuring signals use the plug-in strip from ND1 accessories
2. Signal connections are presented on figures in the view from the ND1 terminal plate side

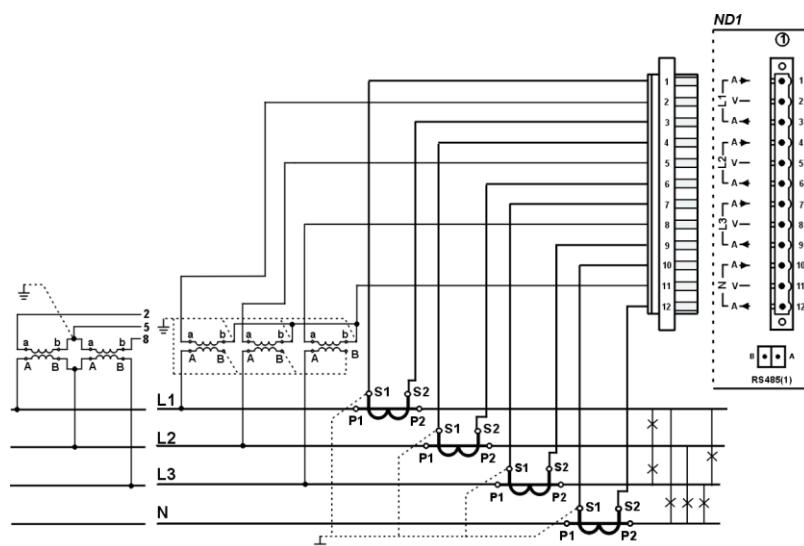

Fig. 4.5. Four-wire network. Indirect measurement with the use of 4 current transformers and 2 or 3 voltage transformers.

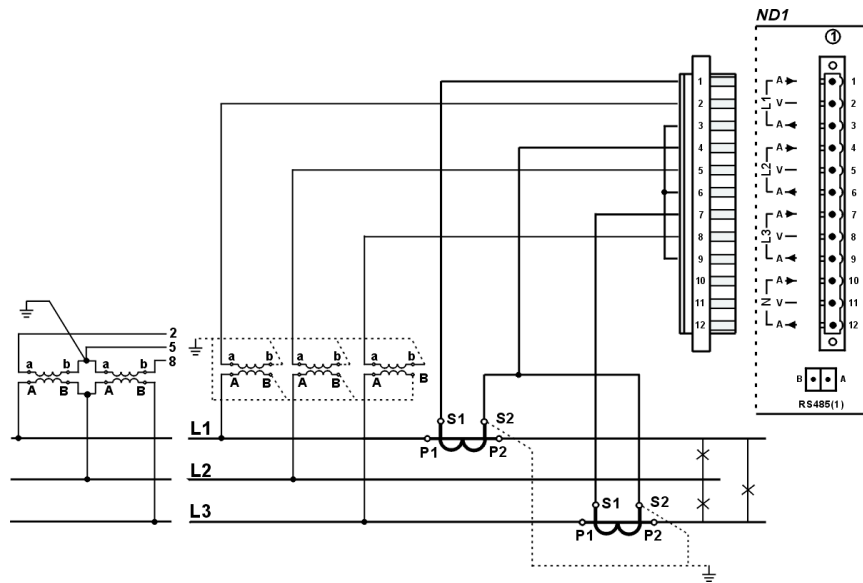

Fig. 4.6. Three-phase network. Indirect measurement with the use of 2 current transformers and 2 or 3 voltage transformers.

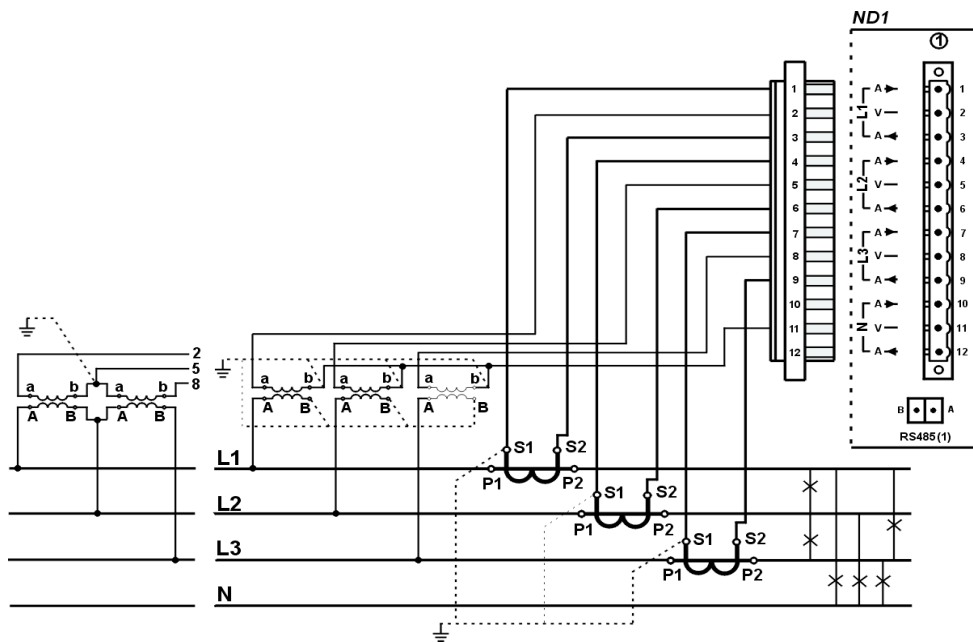

Fig. 4.7. Four-wire network. Indirect measurement with the use of 3 current transformers and 2 or 3 voltage transformers.

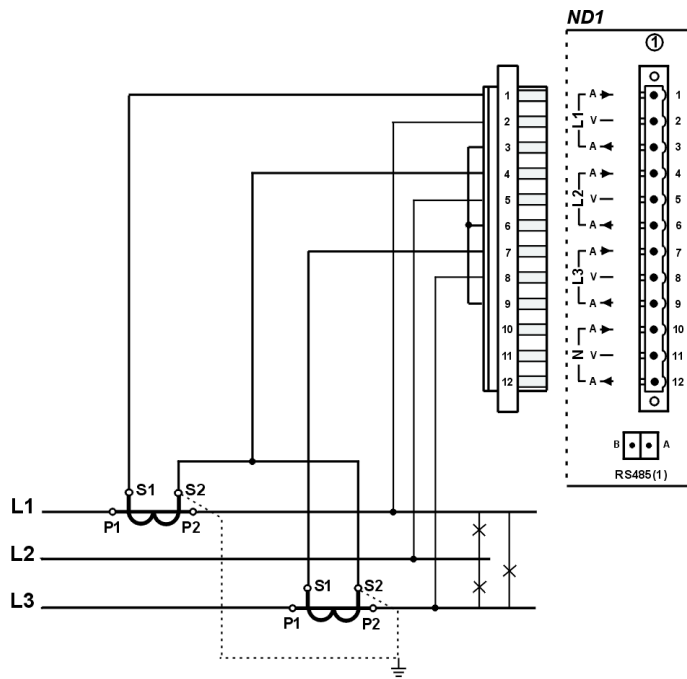

Fig. 4.8. Three-wire, three-phase network. Indirect measurement.

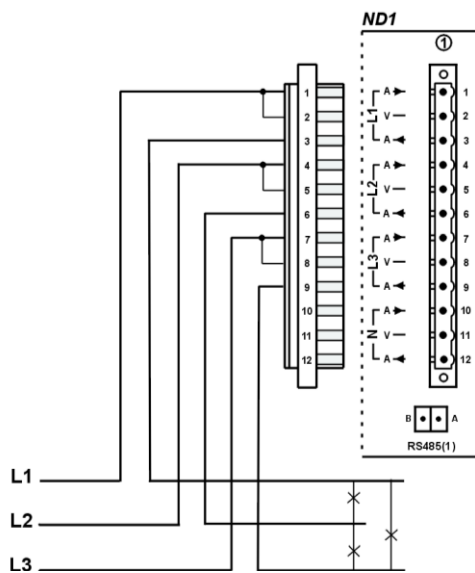

Fig. 4.9. Three-wire, three-phase network. Indirect measurement.

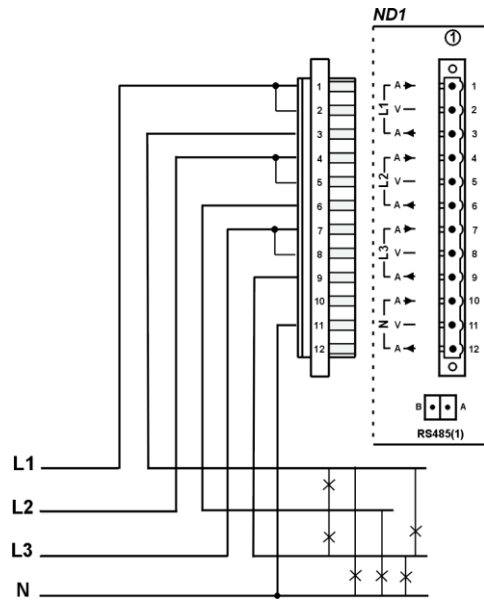

Fig. 4.10. Four-wire network. Direct measurement.

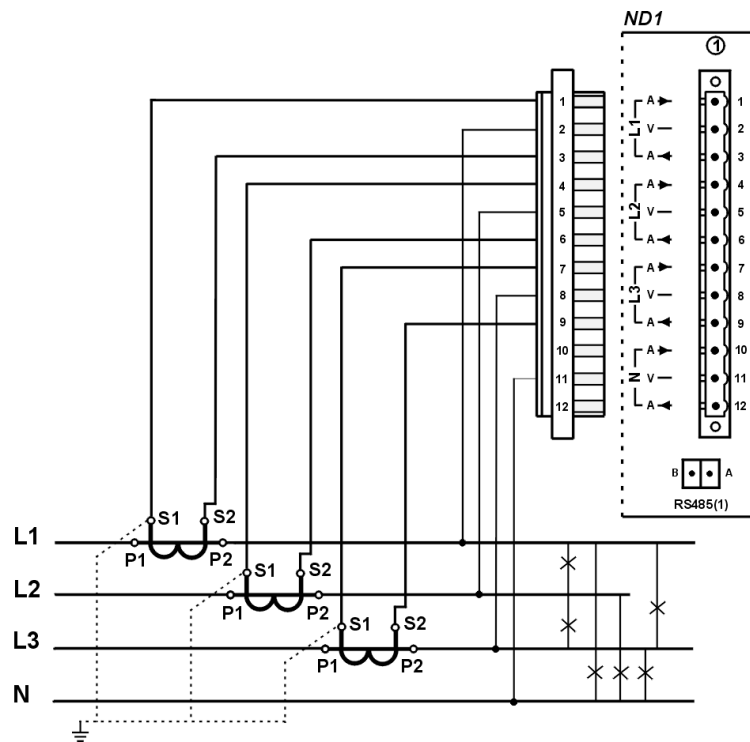

Fig. 4.11. Four-wire network. Semi-indirect measurement.

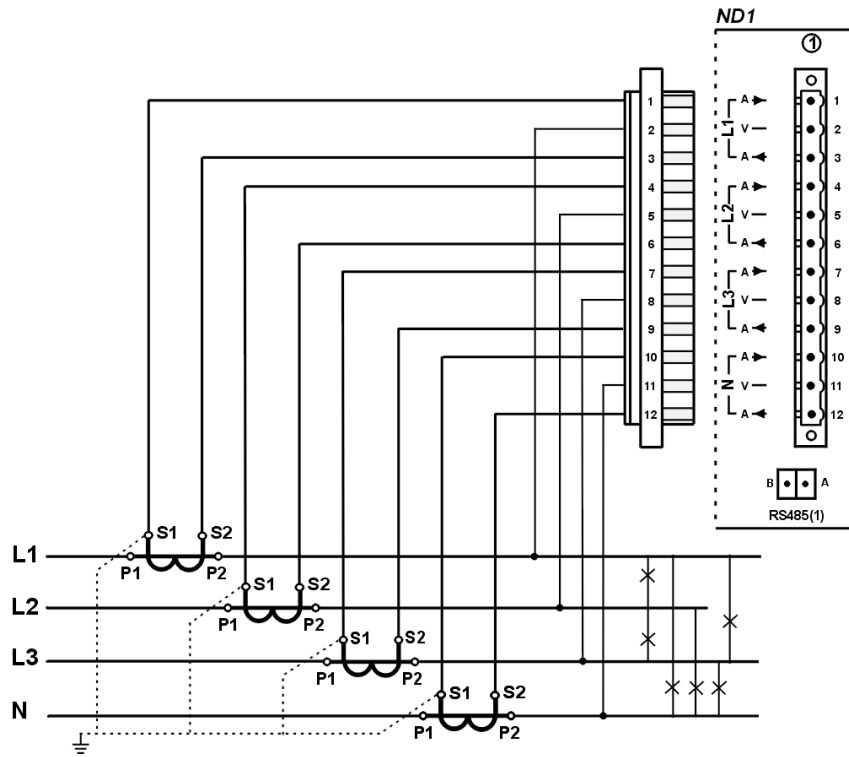
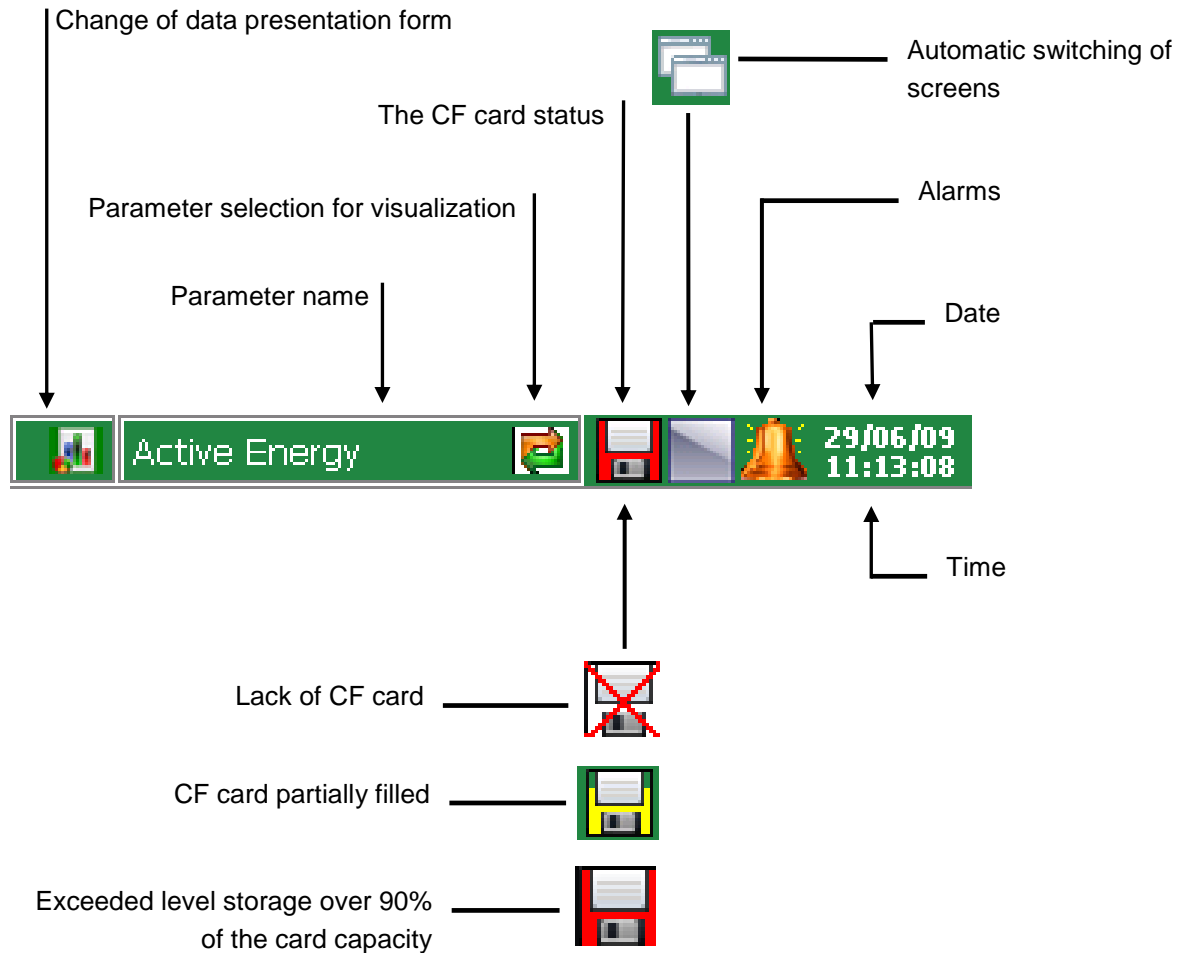





Fig. 4.12. Four-wire network. Indirect measurement with the use of 4 current transformers.





5. Graphic Signs on the Analyzer Screen

5.1.1. Status Bar







5.1.2. Service menu

	Selection approval (OK), enter of changes
	Cancellation, no changes are introduced
	Push-buttons for global navigation
	Push-buttons for navigation on accessible options

	Push-buttons for global copying of settings between menu windows
	Introduction of a number or string
	Option selection from the list or the dialogue
	Context help

5.1.3. Information Messages

	Warning
	Symbol of error occurrence
	Question
	Information icon

5.1.4. Dialogs

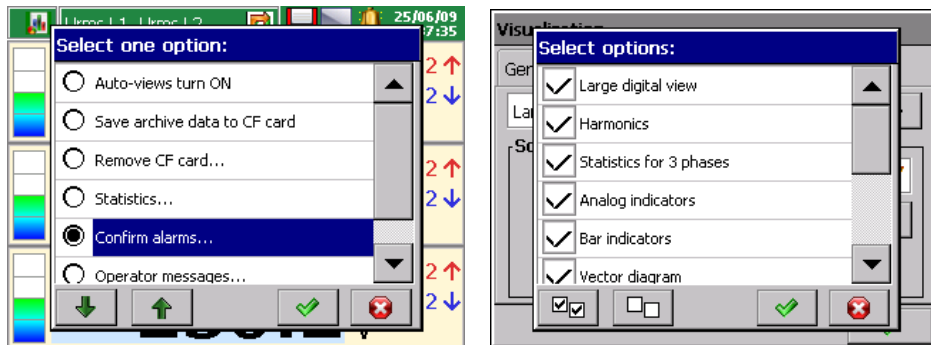

Single and multiple selection.

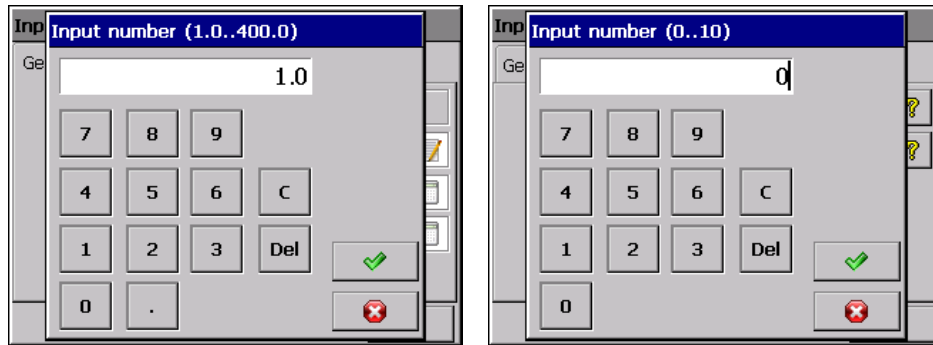

Input numbers (float and integer numbers).

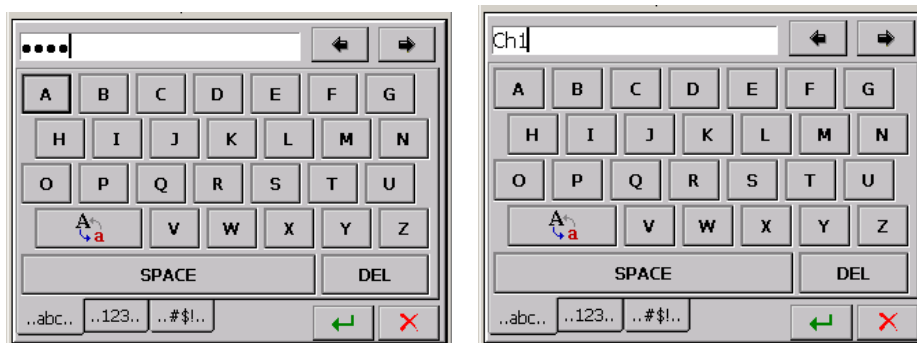







String inputs (small and capital letters, numbers and special characters; password – replaced by dots)

5.2. Signs and Colors of Measuring Parameters

5.2.1. Graphic Signs

Graphic signs used during the visualization process are presented below. (Note: some symbols occur only on selected screens).

	Range exceeding of the measured value over the upper limit and the alarm state in the channel (what the red color informs about).
	Range exceeding of the measured value under the lower limit.
	Lack of value.
ComEr	Communication error (can occur with data values from communication interfaces).

	Alarm occurrence in a channel. This sign may be accompanied by one of the alarm type symbol.
	Signs of alarm types. Suitably: min, max, range off, range on alarm types.
	Incomplete measurement for the given time window or averaging range.
	State of binary inputs, suitably: input in the high state and input in the low state.

5.2.2. Colors of Measuring Values

The following colors of measuring data are introduced for informative purposes:

Black color 123.5	Measurement in standard.
Grey color 123.5	Incomplete measurement for the given time window or averaging period.
Red color 123.5	Alarm occurrence on the displayed value.
Orange color 123.5	Measurement carried out after exceeding 20% of the rated value.

6. Analyzer Start

After the supply connection, the starting screen with the manufacturer logo appears. The logo is displayed during the time necessary to initialize analyzer processes.

Next, the screen of data visualization appears, in form of the last analyzer state before the supply turned off.

After touching the screen any place, the **Context Menu** appears.

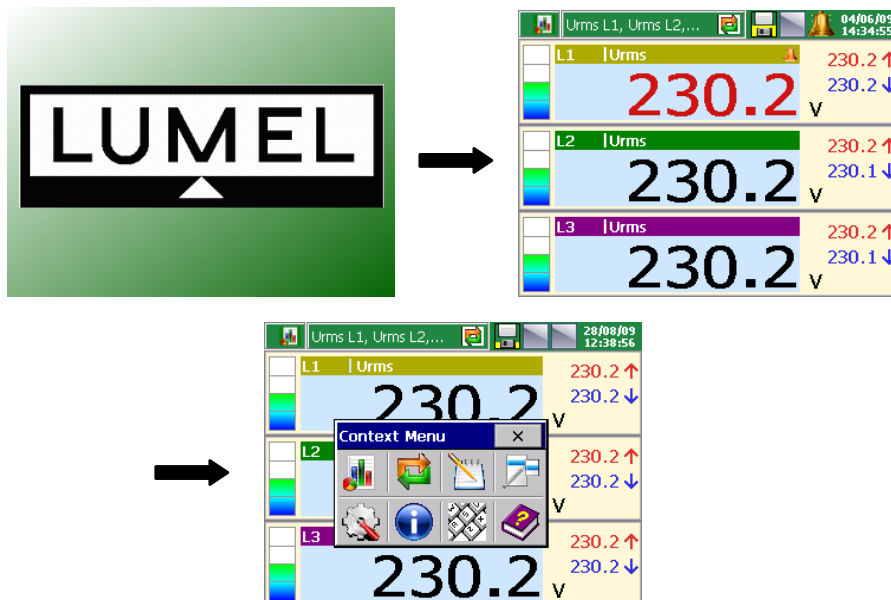



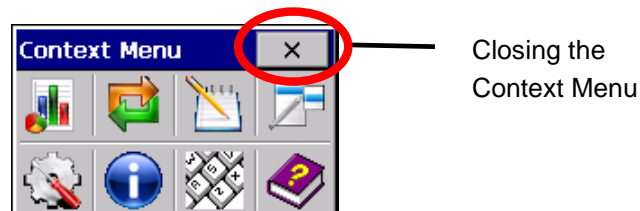

6.1. Context Menu, Button Functions

After pressing the screen during the visualization of measuring data, the **Context Menu** with the standard set of ND1 service options is displayed:







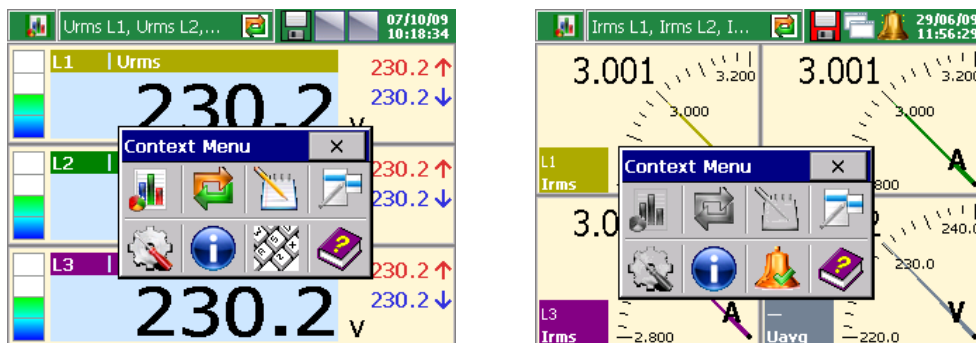

Standard set of functions destined for the current operating of the ND1 analyzer:

	Selection of the screen kind for the presentation of analyzer measuring data.
	Switching of successive screens available for the selected type of data presentation.
	Selection of the log view for statistics, audits or alarms.
	Selection of service options available for the currently open screen.
	Entry to the edition and configuration of analyzer parameters.

You can add to the Context Menu as above, 5 additional icons from 7 programmable options available in: **ND1 Control Panel – General settings – Others – Context menu:**



	Screen-shot button. Captured images are stored in the *.bmp format on the CF card.
	System information dialog.
	A large close button for context menu.
	CF files browser.
	User's custom messages.

	Alarms confirmation.
	Help system. It contains explanation of used symbols and other information.

6.2. Entry to Parameter Configuration, ND1 Control Panel Window

In order to transit into ND1 parameter configuration, please select in the Context Menu the icon of ND1 analyzer configuration menu:

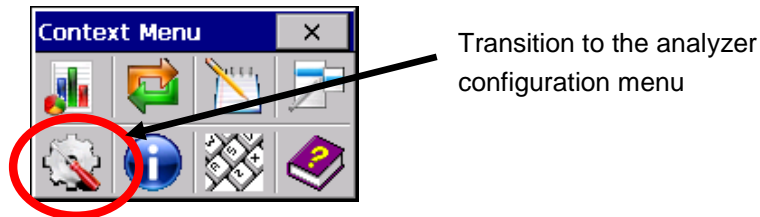

The log in window appears. **At the first start, there is only the Administrator user.** The logging follows **without the password**, simply accepting the window. The Administrator, after going into the **ND1 Control Panel** can edit other users' names and access passwords to the analyzer.

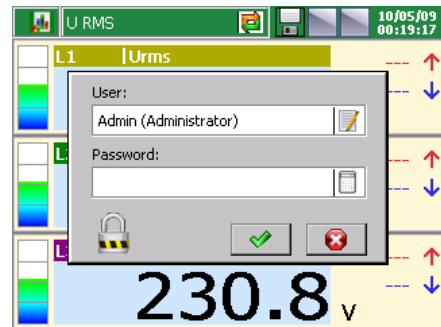

Next, select the kind of the analyzer parameter configuration in the Configuration window:

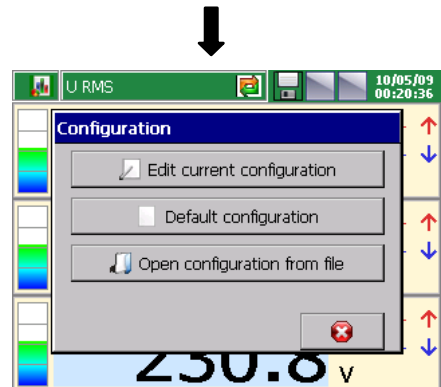

Default configuration	They are manufacturer's settings or given requirements concerning individual settings of the given user.
Edit current configuration	At the first start it is a default configuration, at next starts, the configuration changed by the user in the ND1 control panel.
Open configuration from file	The selection of the configuration file from stored files in the CompactFlash memory card.

The ND1 Control Panel appears. It is the initial point for carrying out the full configuration of the ND1 analyzer.



7. Configuration of ND1

The **ND1 Control Panel** is the window in which all configuration parameters are grouped in different categories:

- analyzer general settings, section 7.1
- input configuration, section 7.2
- alarm configuration, section 7.3
- analog output configuration, section 7.4
- setting of energy quality parameters, section 7.5
- setting of visualization parameters, section 7.6
- setting of archiving parameters, section 7.7
- setting of Ethernet interface parameters, section 7.8
- setting of Modbus interface parameters (Master / Slave), section 7.9
- setting of access principles for analyzer configuration changes, section 7.10
- system information of the analyzer, section 7.11
- files browser on a CF card, section 7.12
- event log, section 7.13



Note: During the analyzer configuration, the measurement and data storage last acc. to hitherto existing settings. When we introduce new settings, after accepting changes, a break in data storage, initialization of changes, and the beginning of write with new data follows.

7.1. General Settings



After pressing the icon the configuration window of basic parameters opens. They are symbol and analyzer description, selection of the menu language, setting of the date and time, capacity of event logs, service of the CF card, service of the LCD screen, setting of user messages and selection of the context menu option.

7.1.1. Parameter Programming: Basic

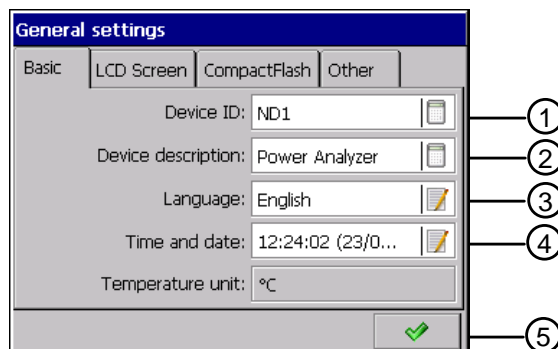

Item	Function
1	Edition of the device symbol
2	Edition of the device description
3	Selection of the menu language
4	Settings: <ul style="list-style-type: none"> – date and time / synchronization of the time with the server – time zones – automatic change of time: S/W – address of the time server (NTP)
5	Setting acceptance

7.1.2. Parameter Programming: LCD Screen

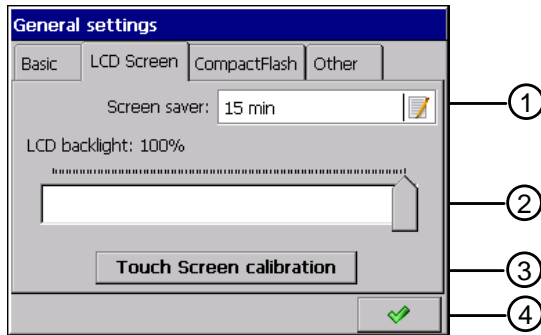

Item	Function
1	Selection of the time to blank the LCD screen: switching off / 5 min...12 hours.
2	Setting of the screen brightness
3	Calibration of the touch screen (see section 8.2)
4	Setting acceptance

7.1.3. Parameter programming: CompactFlash format

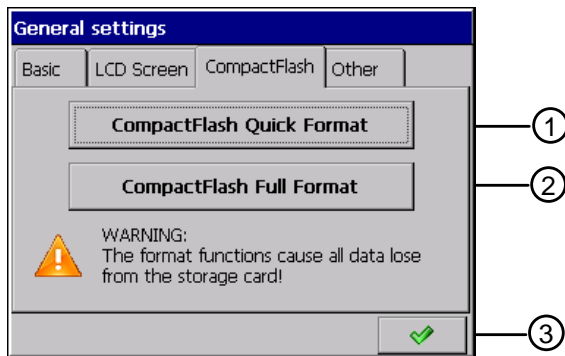

Item	Function
1	CompactFlash Quick format (see section 8.1.2)
2	CompactFlash Full format (see section 8.1.2)
3	Setting acceptance

7.1.4. Parameter programming: Other

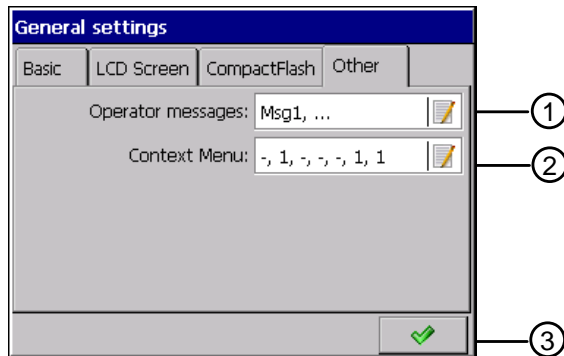

Item	Function
1	Edition 1...10 operator's messages (see section 7.14)
2	Selection of additional options for the Context Menu (see section 6.1)
3	Setting acceptance

7.2. Inputs



After pressing the icon  the configuration window of the analyzer measuring input parameters becomes open (setting of the network base frequency, connection kind, current and voltage ratios, averaging periods, tariffs, quality of RMS voltage and frequency).

7.2.1. Parameter: General

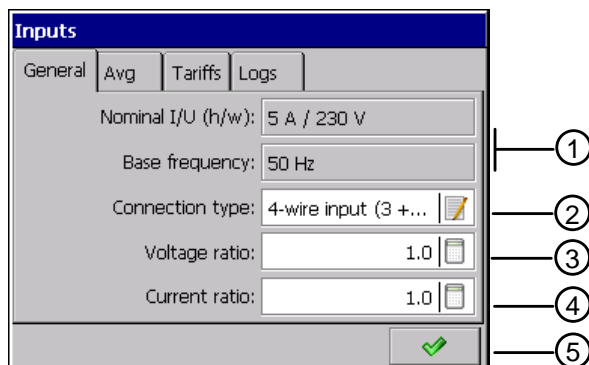

Item	Function
1	Input Power Card nominal values
2	Selection of connection type: <ul style="list-style-type: none"> – 3-wire input – 4-wire input (3 + neutral wire)
3	Edition of voltage ratio values
4	Edition of current ratio values
5	Setting acceptance

Note: For a correct measurement of the zero current, you must prepare suitable terminal connections.

7.2.2. Parameter: Average

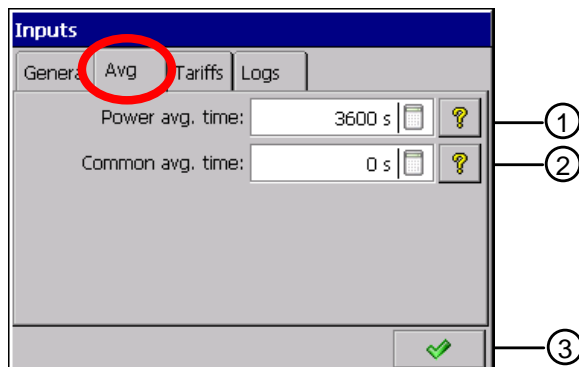

Item	Function
1	Setting of the averaging period for the mean walking 3-phase active power and $\text{tg}\phi$ expressed in seconds
2	Setting of the averaging period for all values (excepting harmonics and THD)
3	Setting acceptance

7.2.3. Parameter programming: Tariffs

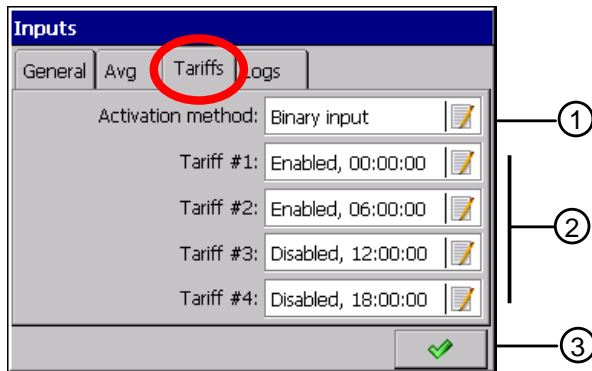

Item	Function
1	Selection of the activation method: <ul style="list-style-type: none"> – Time trigger – Binary input
2	Tariff settings 1..4: <ul style="list-style-type: none"> – Enabled / Disabled – Setting of the selected tariff trigger time
3	Setting acceptance

In case of tariff activation by binary inputs, a physical binary input from 1 to 4 corresponds to relevant tariff number. Please remember that only one tariff can be activated in the given time at the high state of the binary input. Otherwise, all tariffs will be turned off.

In case of the time trigger activation, the start time is the initial point of the twenty-four hours' clock time.

7.2.4. Parameter programming: Logs

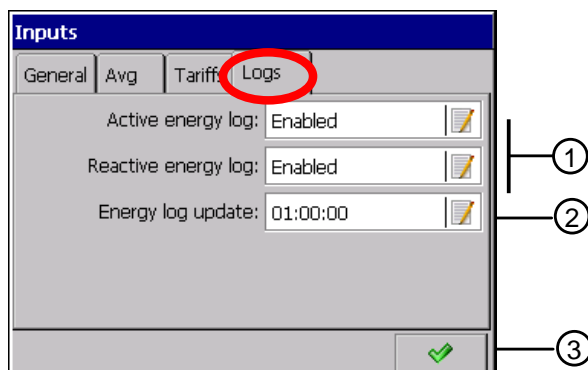

Item	Function
1	On/Off energy log (active / reactive)
2	Setting of the energy log updating frequency
3	Setting acceptance

7.3. Alarms



After pressing the icon selection windows (1...12 alarms) and programming their parameters in **General and Control tabs** become open:

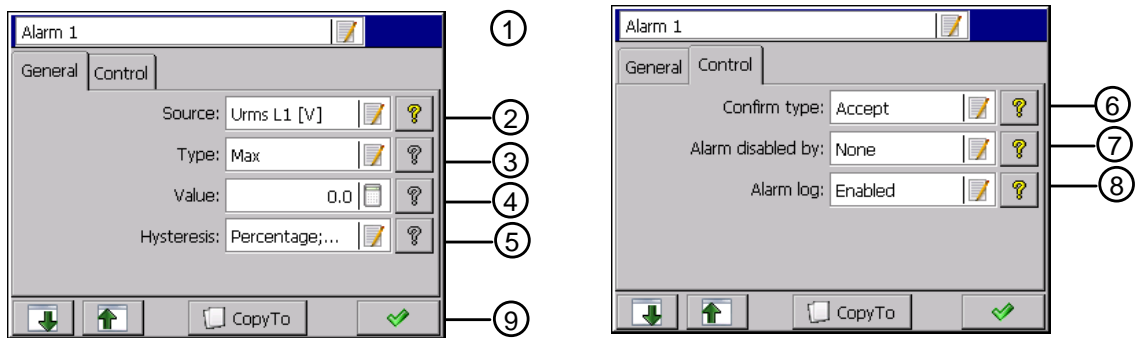

Switching/selection Settings copying to another of alarm (1...12) alarm, here: 2..12

Note: only alarms from 1 to 6 have representation on physical outputs. Remaining alarms from 7 to 12 have a logic character.

7.3.1. Parameter Programming: General

1. Selection of the alarm number from available 1...12
2. Setting of the alarm source: **Disabled** or **selection** of one of the parameters.

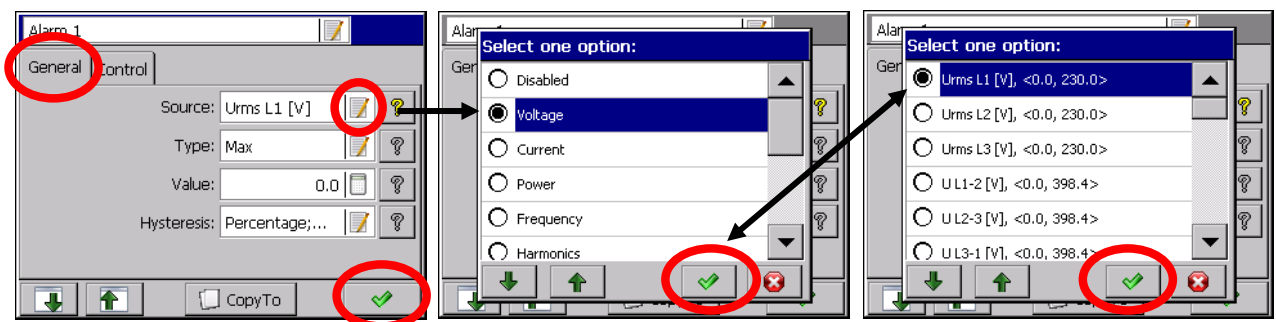

3. Selection of alarm type: **Min, Max, Range On, Range Off**

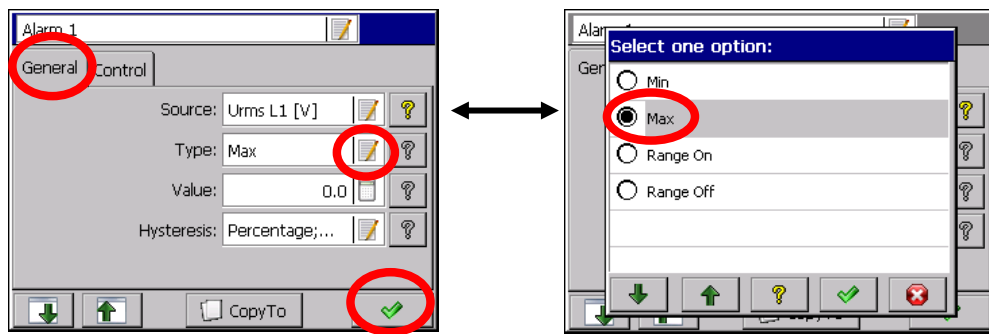

Min, Max - the alarm is enabled when a signal value is below/above the alarm value (**Lower limit, Upper limit**).

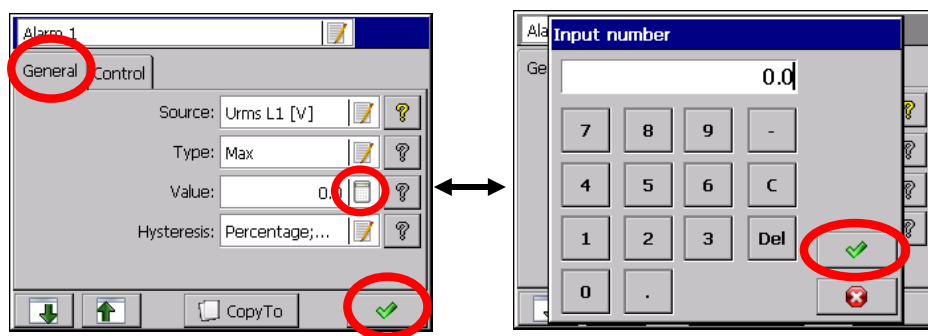

Range On, Range Off – the alarm is enabled when the signal value is between or beyond set alarming values (**Lower limit, Upper limit**).

4. Edition of Alarm value (**lower and upper limit**)

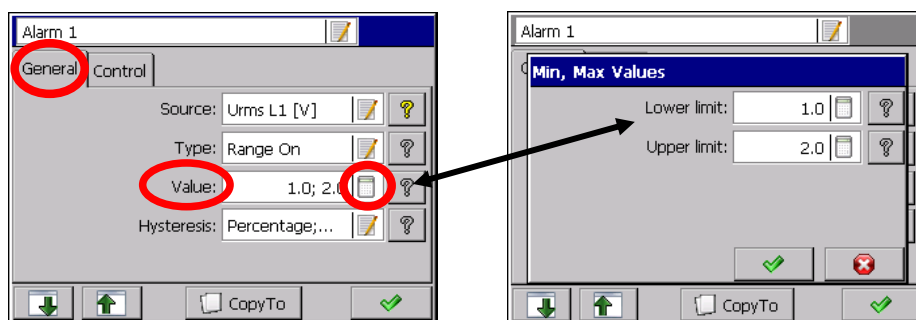

5. Selection of the Hysteresis type and edition of its parameters

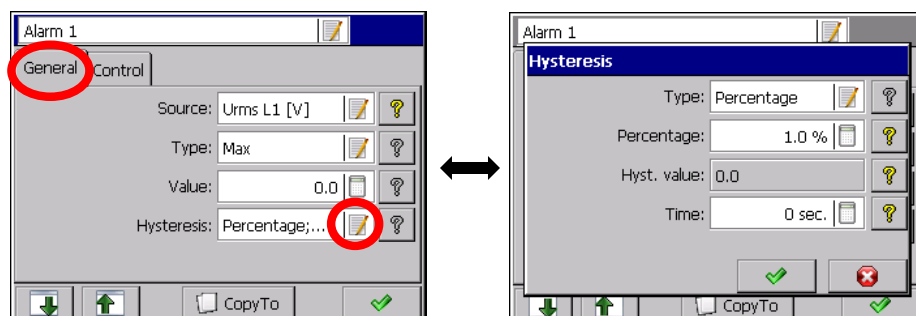

Edition of parameters for the chosen alarm hysteresis type:

Hysteresis	Type	Percentage	Value	Percentage Off	Value Off
Parameters of the selected hysteresis type	Percent	Edition of the value In percentage of the range	n/a	Edition in percentage of the range	n/a
	Hyst. value	n/a	Edition of the value in the range unit (positive value)	n/a	Edition of the value in the range unit (positive value)
	Time	Hysteresis value in the time unit			

After programming the valuable or percentage alarm hysteresis and higher in time than zero, the alarm operation follows when both conditions are fulfilled simultaneously.

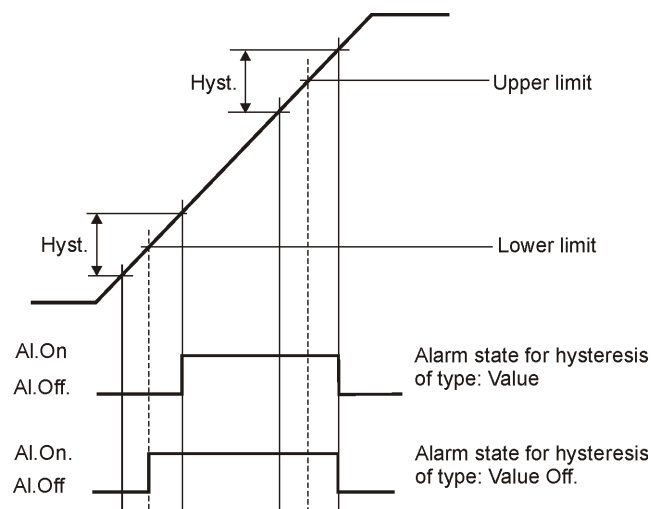

Fig. 7.1. Functional diagram of the **Value Off** alarm type

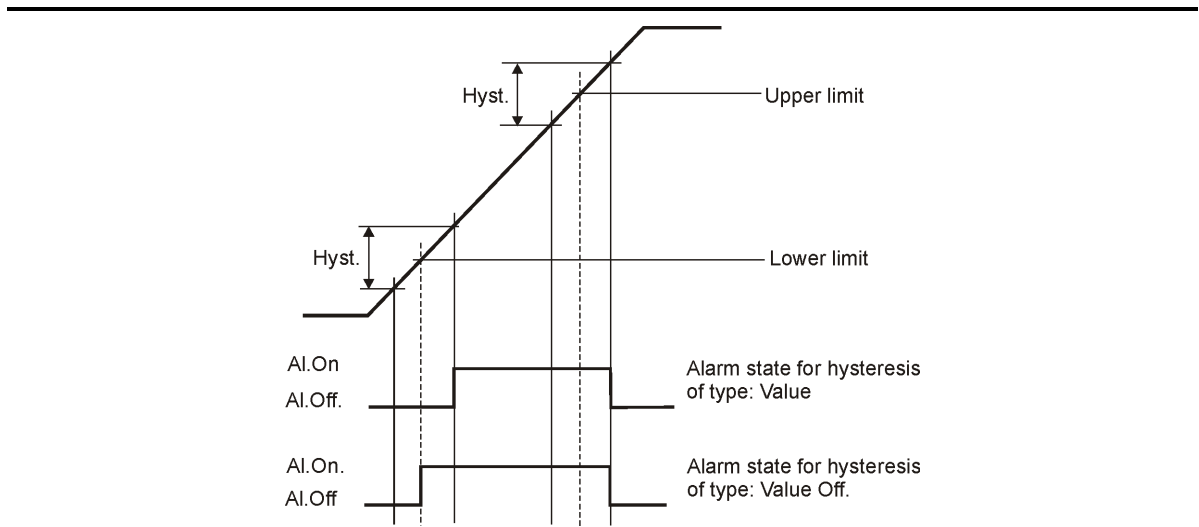

Fig. 7.2. Functional diagram of the **Value On** alarm type

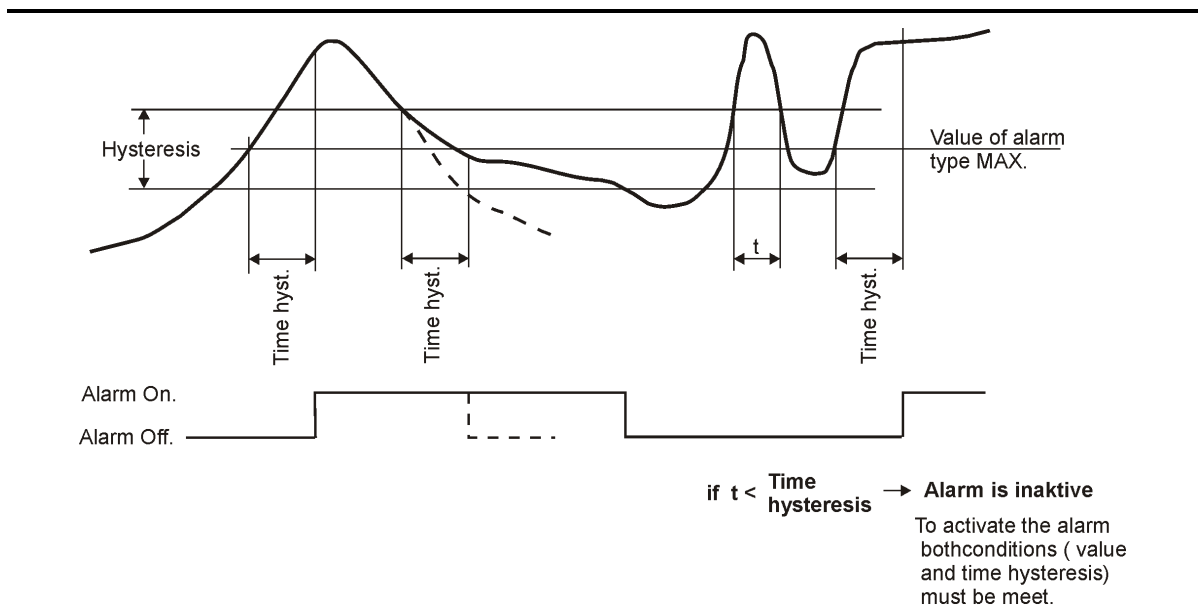
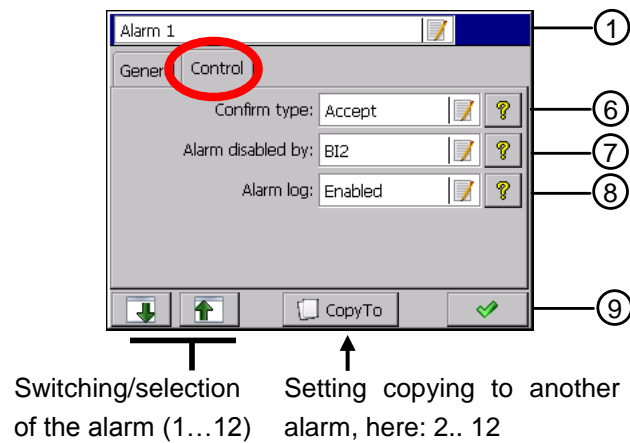

Fig. 7.3. Functional diagram of the **MAX** alarm type taking in consideration the hysteresis of **Value** and **Time** type

7.3.2. Parameter Programming: Control



Description of the reference marks:

6. Selection of alarm **Confirmation type**:

None	Option disabled
Latch	The alarm state is supported in the analyzer as long as it will not be confirmed by the operator
Accept	Switching the alarm state off in the analyzer by the operator

During the analyzer operation, you can select in the context menu the option of alarm confirmation acc. to programmed settings.

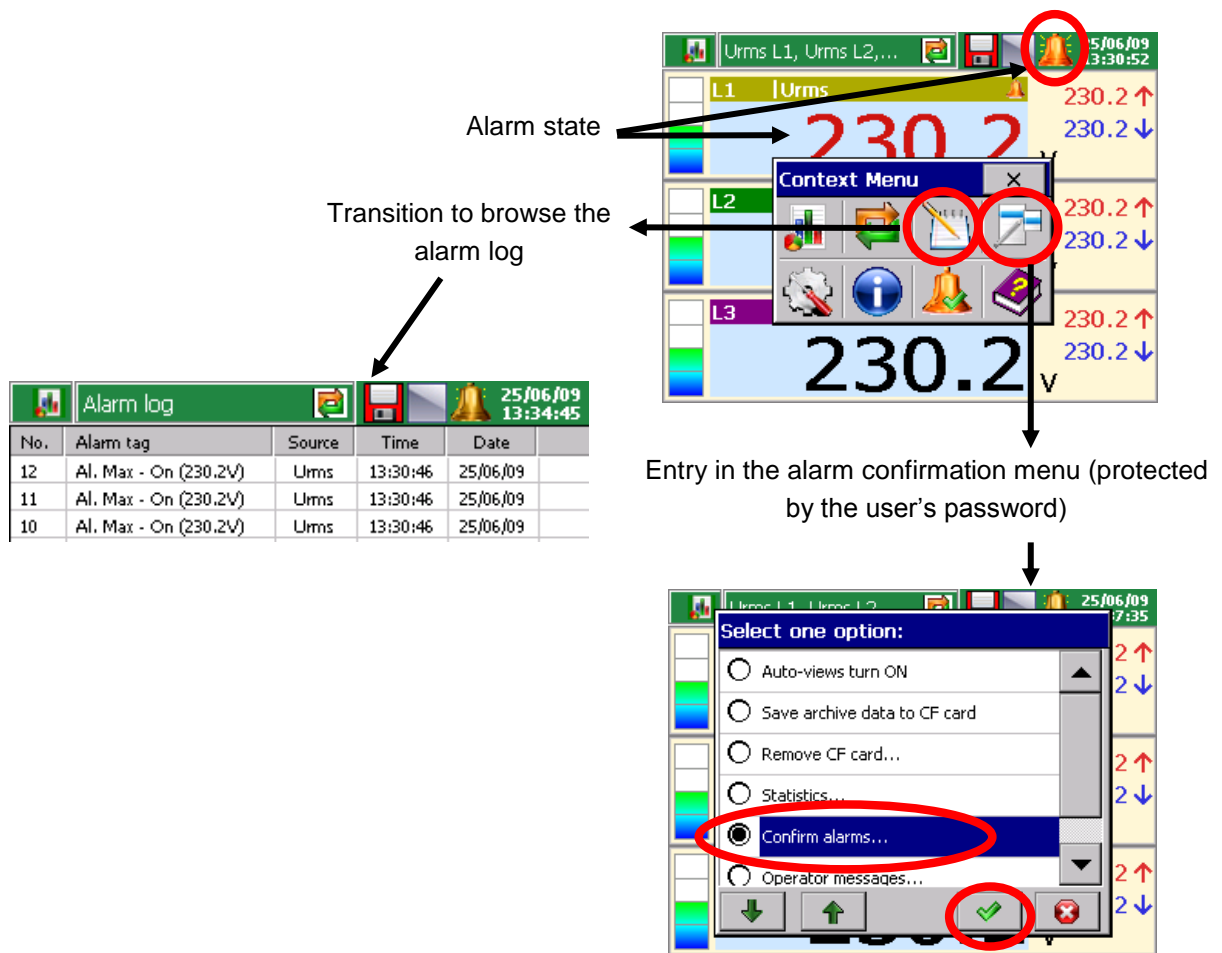

7. Selection of the alarm locking source:

None	Option disabled
BI1...BI12	Selection of binary input which the logic state 1 (ON) will lock the current state of the selected alarm

8. Setting of message storage in the alarm log:

Enabled	information about the occurrence of alarm states will be saved in the log
Disabled	messages about alarm states will not occur

9. Acceptation of alarm settings

7.4. Analog Outputs



After pressing the icon  the window for the selection and configuration of 1...4 analog outputs become open.

7.4.1. Selection of the Analog Output

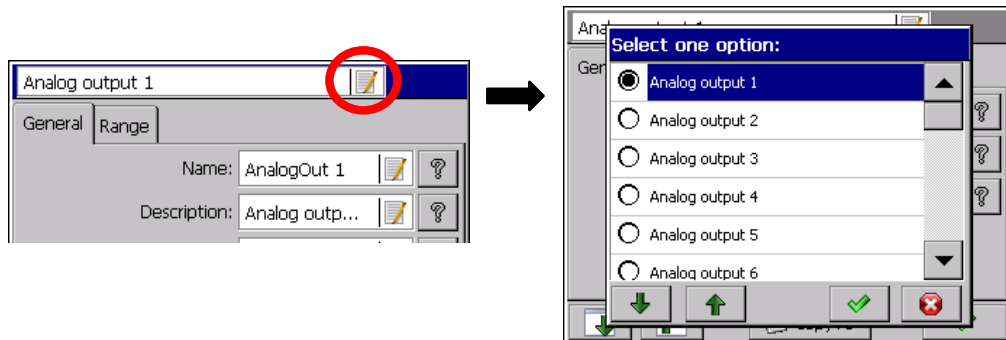

7.4.2. Parameter Programming: General

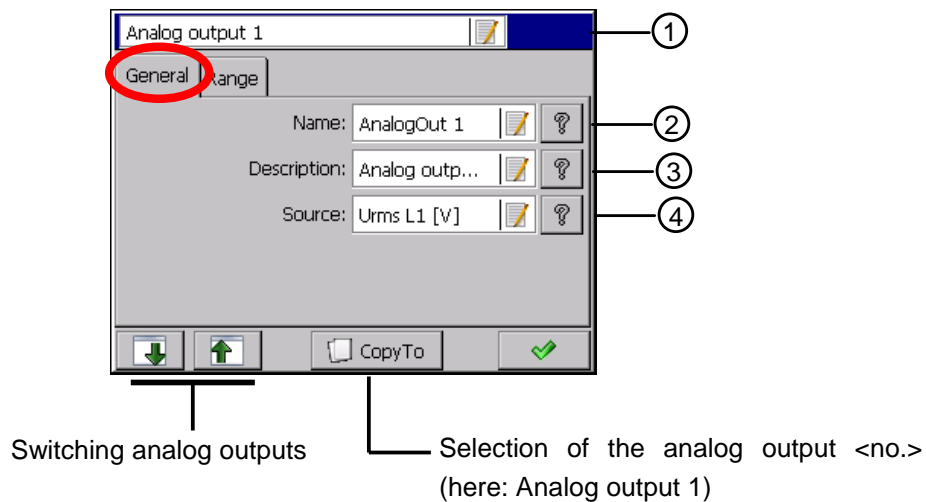

Item	Function
1	Analog output selection from available :1..4
2	Edition of the analog output name
3	Edition of the output description
4	Signal source selection for the selected analog output
7	Settings acceptance

7.4.3. Parameter Programming: Range

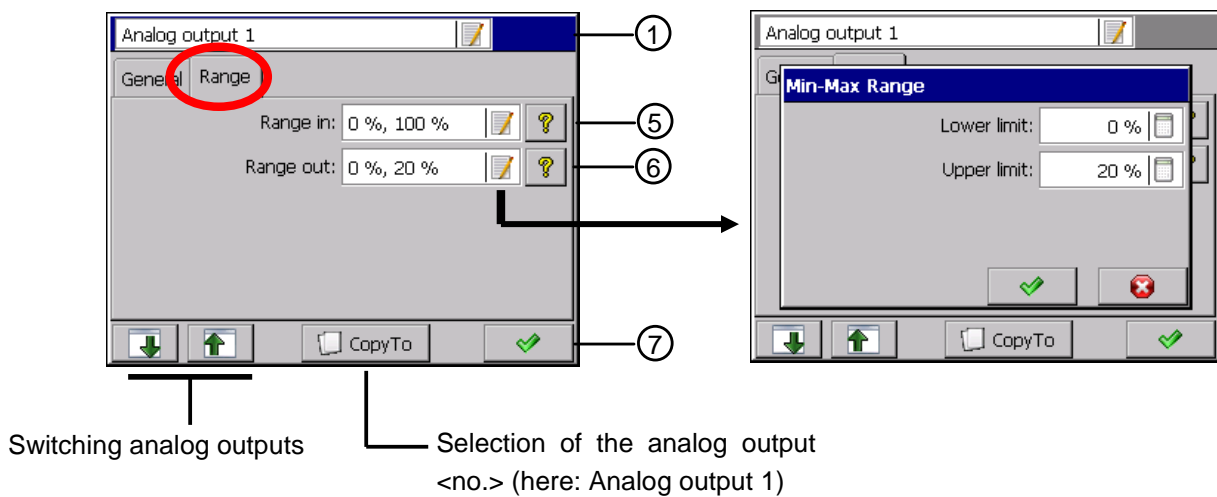

Item	Function
5	Edition of the input range (in %): Setting of the lower and upper range values (Lower/Upper limit)
6	Edition of the output range (in %): Setting of the lower and upper range values (Lower/Upper limit)
7	Settings acceptance

7.5. Power quality



After pressing the icon  the selection and configuration window of **power quality parameters** (General and Dips) opens. Power quality parameters are defined acc to the EN 50160 standard.

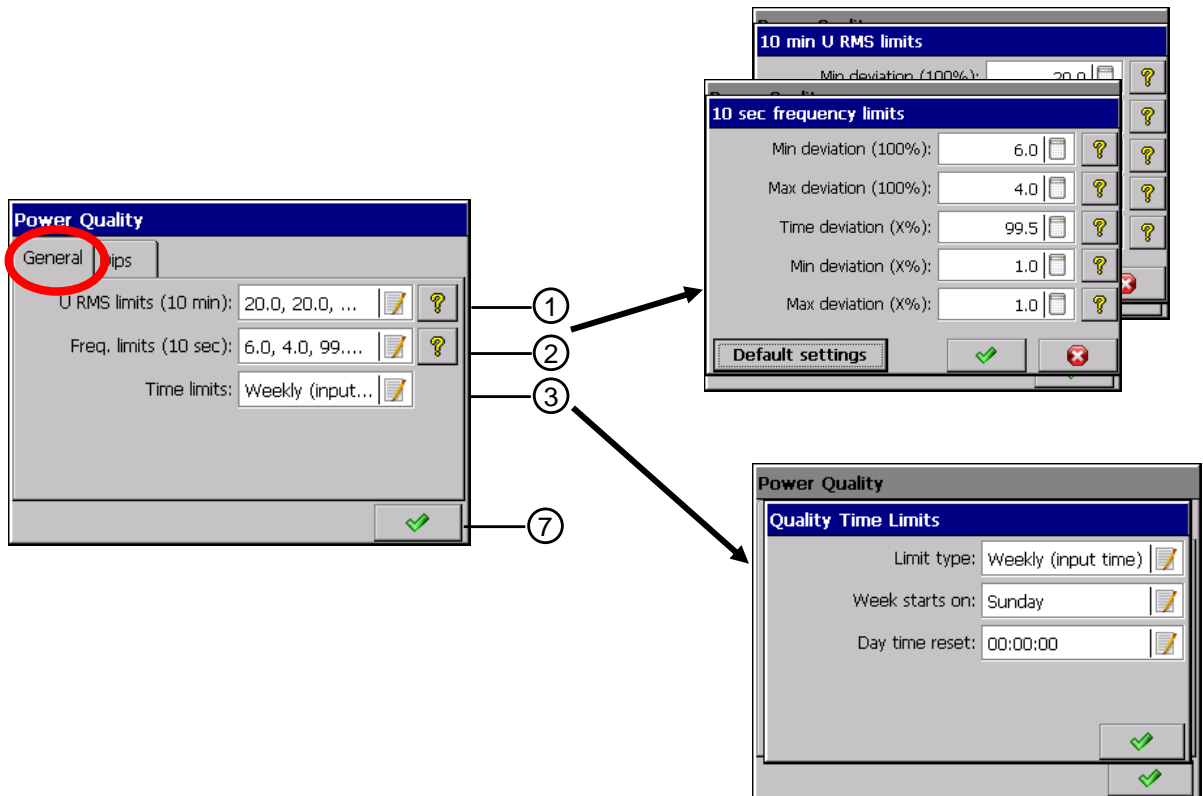

7.5.1. Parameter Programming: General

Item	Function
1	<p>10 min. U RMS limits - Configuration of RMS voltage quality parameters for 10 minutes' period (default settings acc.to EN 50160):</p> <ul style="list-style-type: none"> – Min deviation (100%): setting of admissible U RMS deviation percentage downwards for a 100% probability – Max deviation (100%): setting of admissible deviation percentage upwards for a 100% probability – Time deviation (X%): time percentage in which U RMS has to be in definite limits – Min deviation (X%): admissible U RMS deviation percentage

	<p>downwards for the selected probability</p> <ul style="list-style-type: none"> – Max deviation (X%): admissible U RMS deviation percentage upwards for the selected probability – Default settings: manufacturer's settings for the given parameter group
2	<p>10 sec. frequency limits: configuration of frequency quality parameters for 10 seconds' periods (default settings acc. to EN 50160):</p> <ul style="list-style-type: none"> – Min deviation (100%): setting of the admissible frequency deviation percentage downwards, for a 100% probability – Max deviation (100%): setting of the admissible frequency deviation percentage upwards, for a 100% probability – Time deviation (X%): setting of the time percentage in which, the frequency has to be situated in definite limits – Min deviation (X%): setting of the admissible frequency deviation percentage downwards, for the selected probability – Max deviation (X%): setting of the admissible frequency deviation percentage upwards, for the selected probability – Default setting: manufacturer's settings for the given parameter group
3	<p>Time limits (selection of the counting time):</p> <p>Weekly (input time) - counted from the selected day of the week with the definite time of daily reset</p> <p>Weekly (Power on time) - counted since the analyzer switching on</p>
7	Setting acceptance

7.5.2. Parameter Programming: Dips

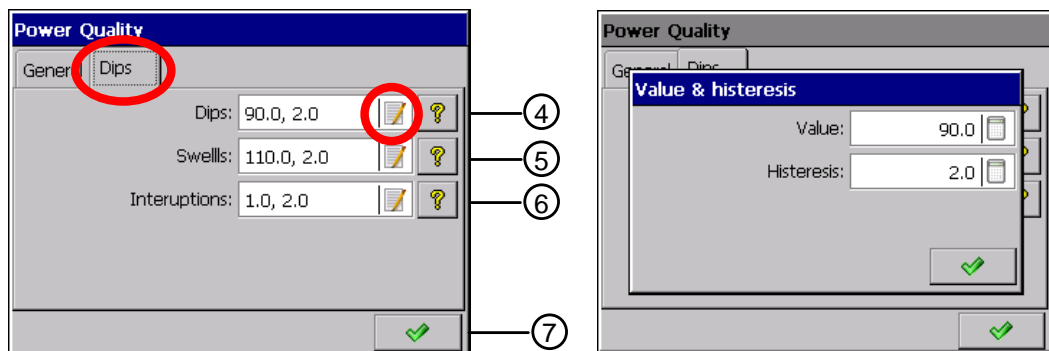

Item	Function
4	Setting of the voltage dip threshold value and hysteresis in percentage of the nominal U RMS value
5	Setting of the voltage flare threshold value and hysteresis in percentage of the nominal U RMS value
6	Setting of the voltage decay threshold value and hysteresis in percentage of the nominal U MRS value
7	Setting acceptance

Power quality parameter definitions:

Voltage interruption – state, in which the voltage is lower than 1% of the declared voltage.

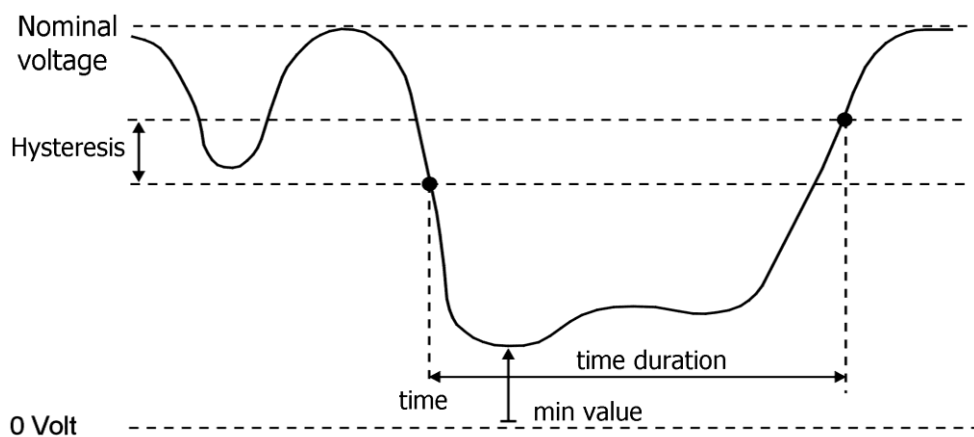

Voltage dip – sudden decrease of the voltage to the value included in the interval from 90% to 1% of the declared value, after which an increase of voltage follows up to the previous value. Conventionally, the voltage dip duration is situated from 10 ms to 1 minute.

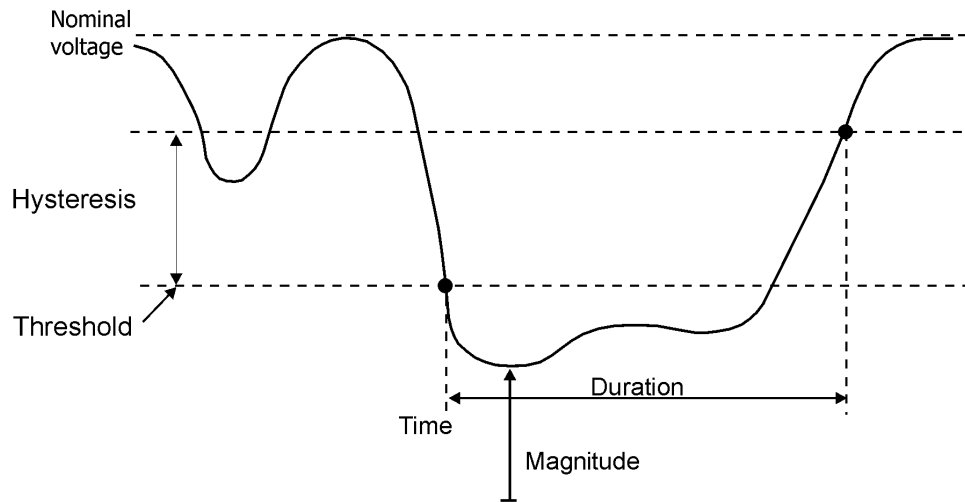

Voltage swell – the temporary increase of the voltage RMS value in a grade exceeding the normally accepted tolerance interval (in reference to the rated or declared voltage).

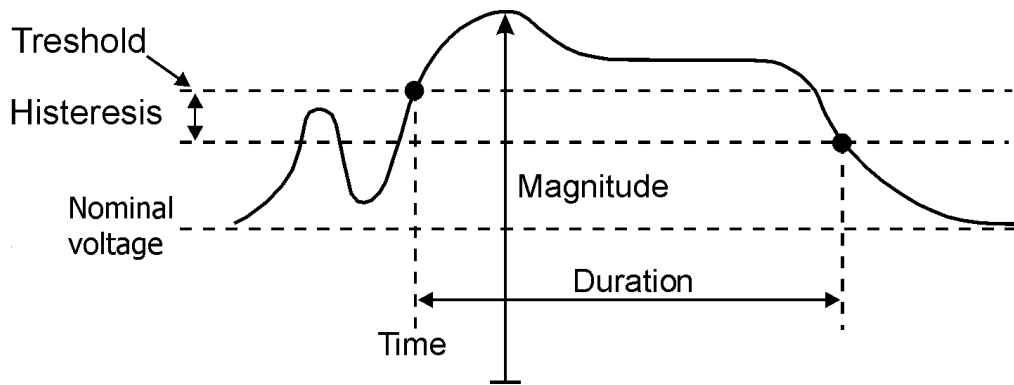

7.6. Visualization



After pressing the icon  the window of selection and visualization parameter configuration of measurement result becomes open.

7.6.1. Parameter: General

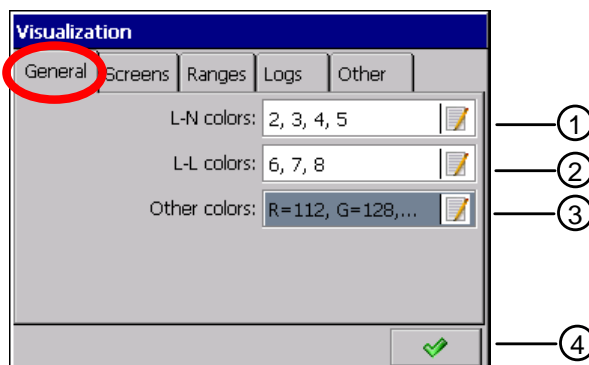

Item	Function
1	Selection of colors for phase charts: – L1, L2, L3, N
2	Selection of colors for line-to-line charts: – Color L1-2, L 2-3, L 3-1
3	Color selection for all remaining quantities
4	Setting acceptance

7.6.2. Parameter: Screens

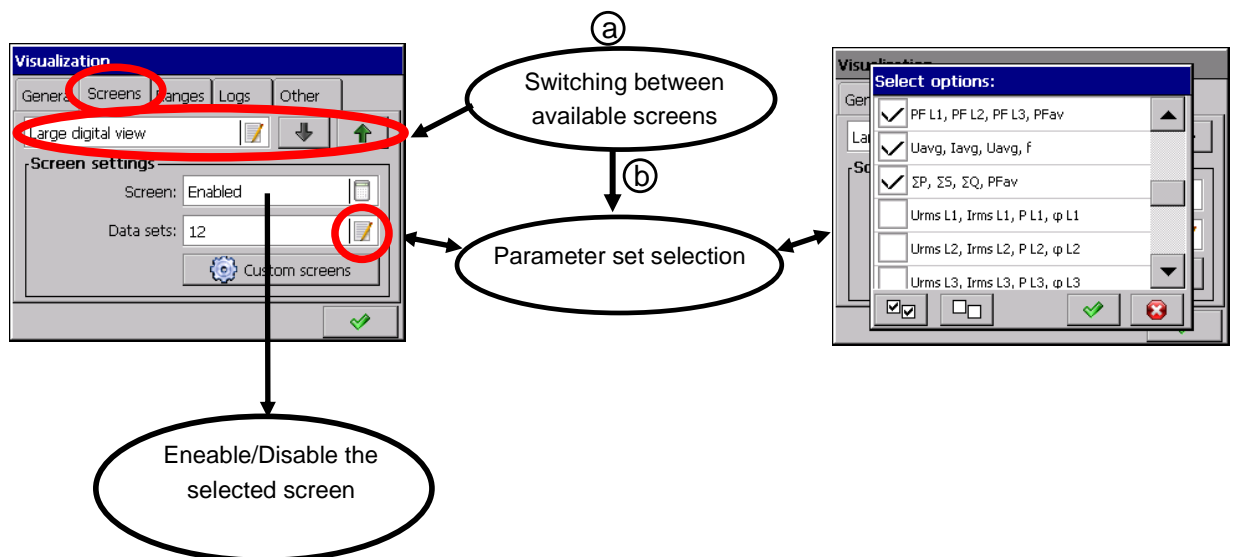

Measuring data can be presented on following screen types:

- Large Digital view
- Harmonics
- Statistics for 3 phases
- Analog indicators
- Bar indicators
- Vector diagram
- Binary inputs
- Energy view

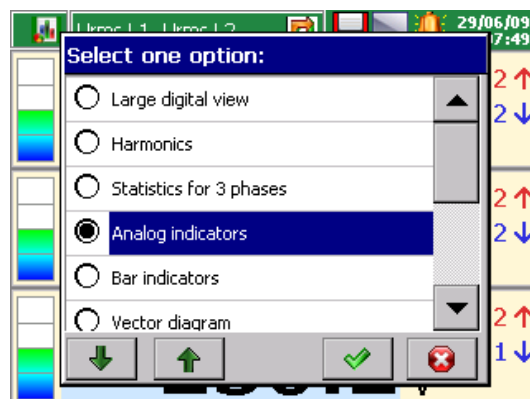

- Power Quality view
- Modubs Master state

For each of these screen types, the dedicated group of parameters for them is available. You can select from this group one for the presentation.

Large digital view

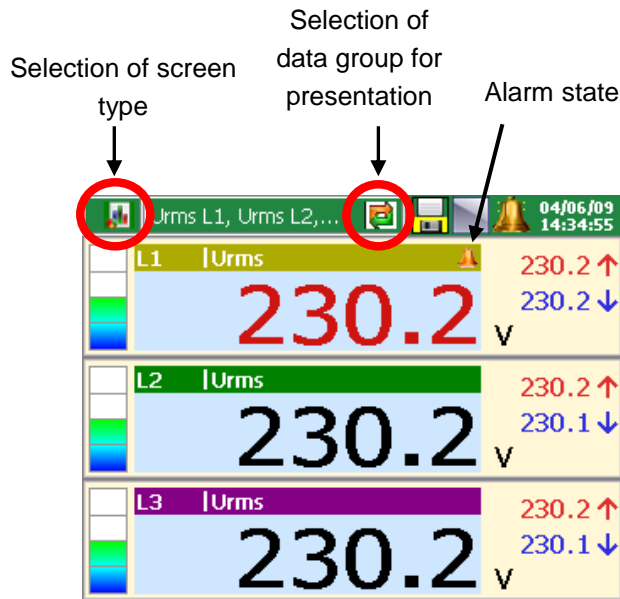

Harmonics

There are 6 data groups for presentation: Harm U, Harm I, Harm table U, Harm table I, Harm table U, Harm table I, Harm table Umax, Harm table Imax.

Line switching:

L1/L2/L3 /L1+L2+L3

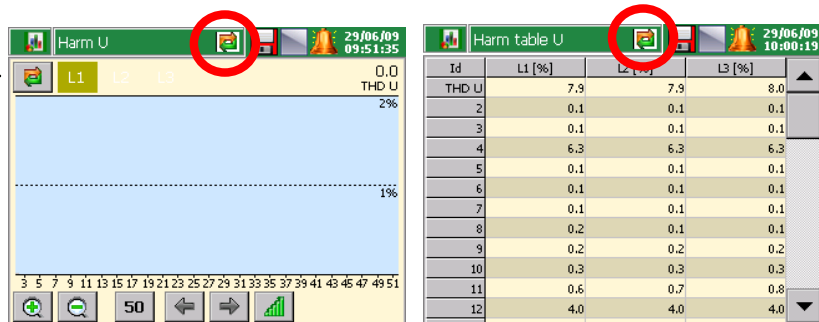

Selection of even/odd harmonics

Scrolling of harmonic charts

Selection of the visible number of harmonics 13/25/51

Statistics for 3 phases

There are 2 data groups for presentation:

- Statistics U
- Statistics I

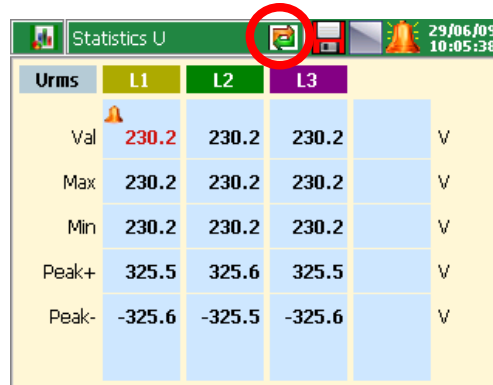

Urms	L1	L2	L3	
Val	230.2	230.2	230.2	V
Max	230.2	230.2	230.2	V
Min	230.2	230.2	230.2	V
Peak+	325.5	325.6	325.5	V
Peak-	-325.6	-325.5	-325.6	V

Analog indicators

This view is a set of four displays modeled on analog meters. Alarm symbol – if occurs – is appeared under the form of a bell above the unit area.

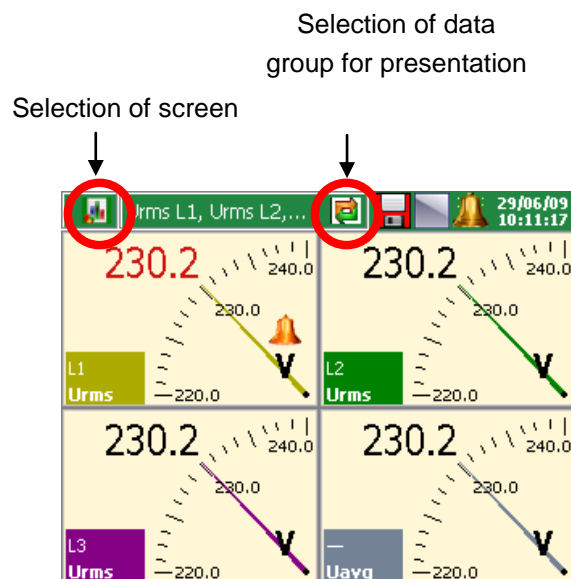

Bar indicators

The bar view is a set of 4 bargraphs with fields including the actual digital value. Indexes at the bargraph left side indicate reached minimum and maximum. The column accepts the red color in case of an alarm occurrence.

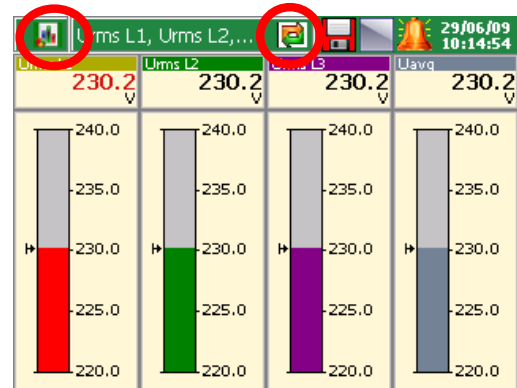

Vector diagram

Three data groups are available for presentation: Phrasal diagram U, I and L-L.

If values of phase parameters, in relation to which the chart is calibrated are indeterminated or take zero, the calibration is carried out in relation to the rated parameter value.

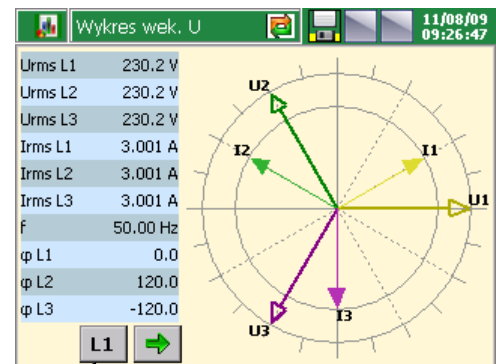

Selection of a phase by which vectors will be scaled to

Selection of a star axis

Binary inputs state

Indexes show the current state:

- Enabled. – the index lights,
- Disabled – the index is blanked.



Energy view

Energy data (Active, Reactive, Summary, Tariff) are presented on 3 screen types.

Active energy

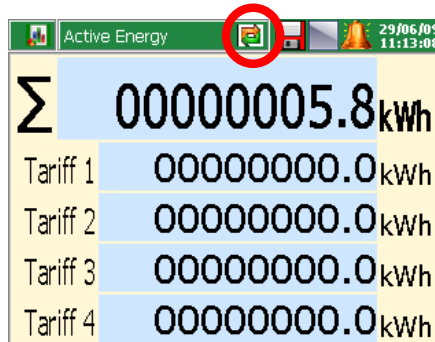

Active Energy	
Σ	00000005.8 kWh
Tariff 1	00000000.0 kWh
Tariff 2	00000000.0 kWh
Tariff 3	00000000.0 kWh
Tariff 4	00000000.0 kWh

When the given tariff is set as active (ND1Control Panel - Inputs - Tariffs), the energy value accounted in it, will be displayed on a darker background

Reactive energy

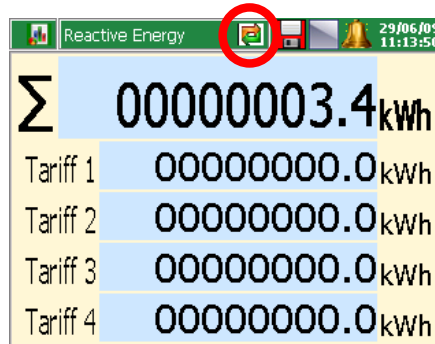

Reactive Energy	
Σ	00000003.4 kWh
Tariff 1	00000000.0 kWh
Tariff 2	00000000.0 kWh
Tariff 3	00000000.0 kWh
Tariff 4	00000000.0 kWh

Selection of an energy screen

Energy summary

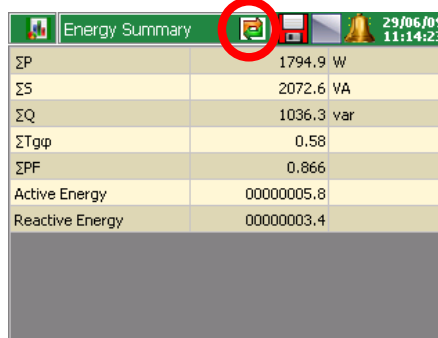

Energy Summary	
ΣP	1794.9 W
ΣS	2072.6 VA
ΣQ	1036.3 var
$\Sigma Tg\phi$	0.58
ΣPF	0.866
Active Energy	00000005.8
Reactive Energy	00000003.4

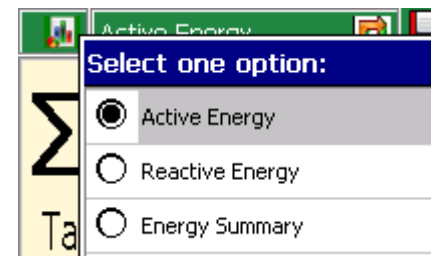

Power Quality view

Energy quality parameters are presented on two screens: PQ Main and PQ Summary.

Modbus Master state

This table view depicts Modbus Master inputs state (only those which are enabled).

Visualization – working with data views

After programming settings and opening a new configuration in ND1, measuring data are presented in set as above graphical form by the user:

The selection of the screen type and parameters from the programmed data set for it, can be made from the Context Menu and from the information bar on the currently displayed screen.

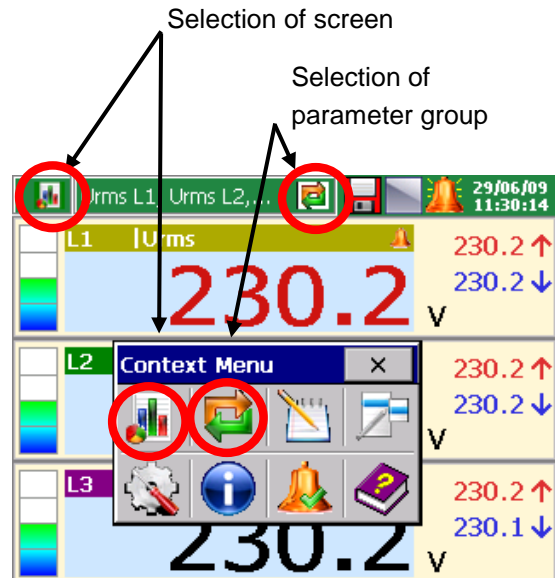

Example of screen selection:

- 1) Selection of the parameter group to display on the screen
- 2) Selection of the screen set



7.6.3. Parameter Programming: Ranges

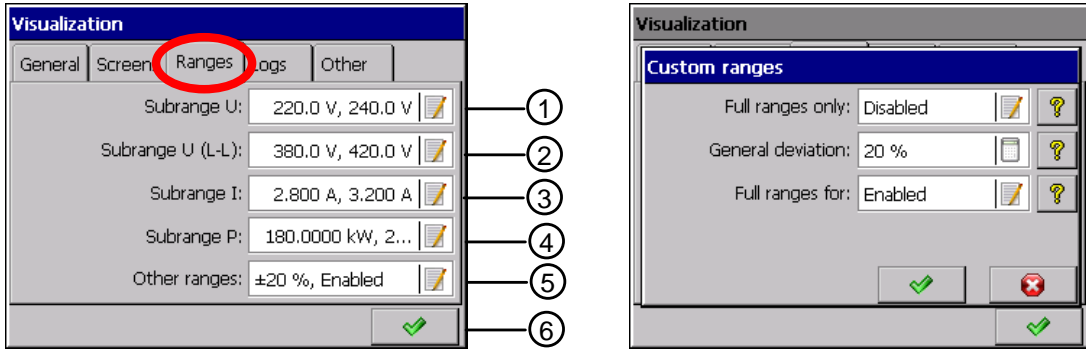

Item	Function
1	Edition of the sub-range U
2	Edition of the sub-range (L-N)
3	Edition of the sub-range I
4	Edition of the sub-range P
5	Edition of remaining parameters: <ul style="list-style-type: none"> – Percentage deviation from rated values for remaining subranges. – list of exceptions shown in a full scale. Demonstration of all subranges in a full scale (then, all subrange settings are ignored).
5	Settings acceptance

7.6.4. Parameter Programming: Logs

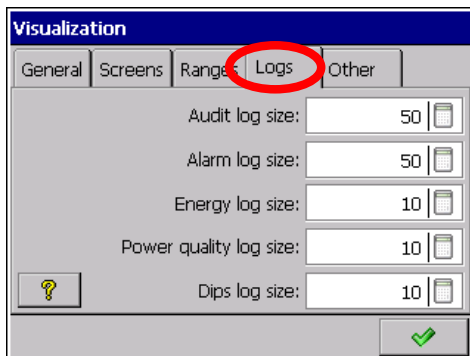

The following logs are available:

- Audit log
- Alarm log
- Energy log
- Power Quality log
- Dips and swallows log

Note: These settings concern only the number of data selected for the visualization (max. 50) and they do not influence storage settings.

7.6.5. Parameter Programming: Other (auto-views)

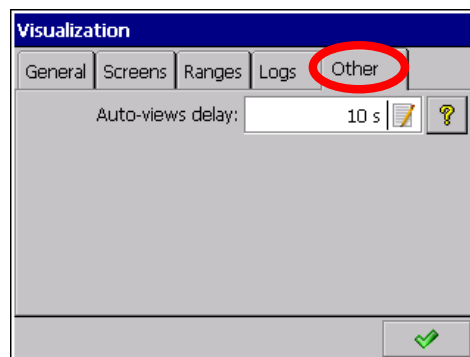

- **Auto-views delay:** setting of screen switching time in automatic mode

The automatic mode of screen switching can be enabled from the Context Menu during data measurements and visualization.

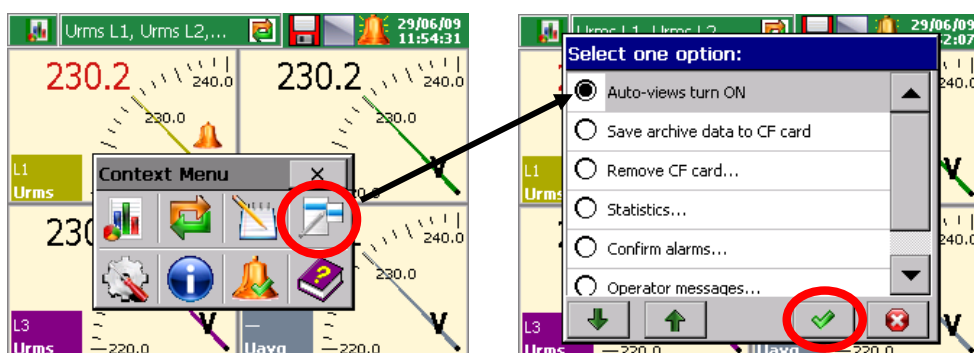

The change of the automatic mode screen switching follows after the selection and acceptance the disable option in the context Menu.

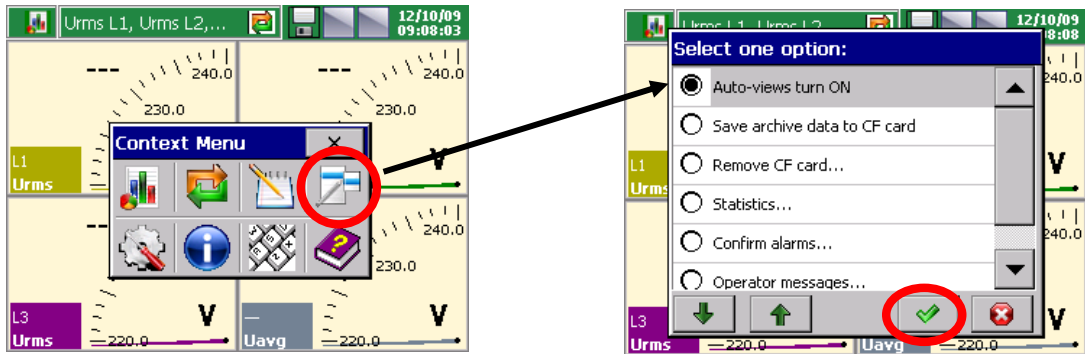

7.7. Archivization



After pressing the icon **Archivization** in the ND1 control Panel the selection and configuration window of archiving parameters for 1..4 measuring groups become open.

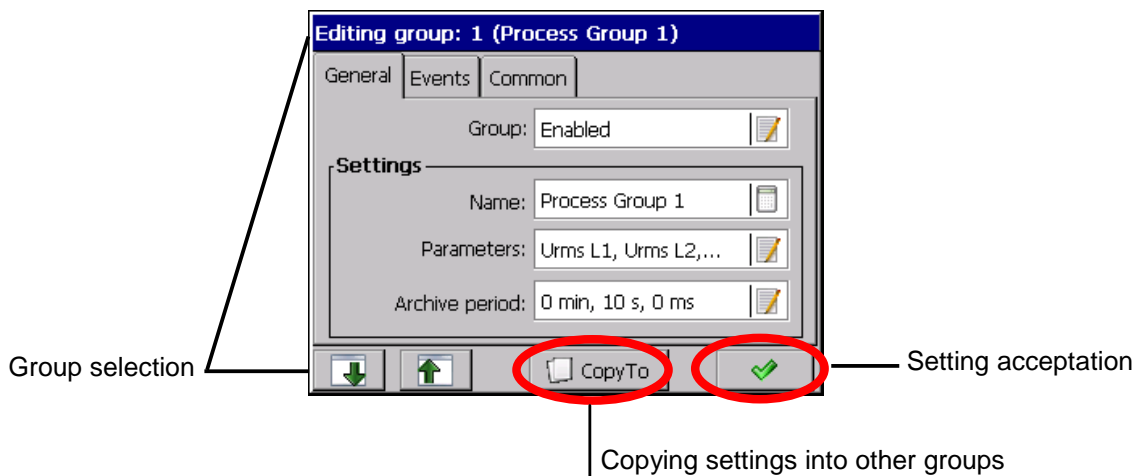

Maximum archiving interval is 720 minutes, however minimum is 100 ms.

7.7.1. Programming of Group Parameters

In the general tab, for each of edited measuring group, one can enable or disable the given group, edit the group name, select maximally up to 12 measuring quantities and set the storage period of measuring data.

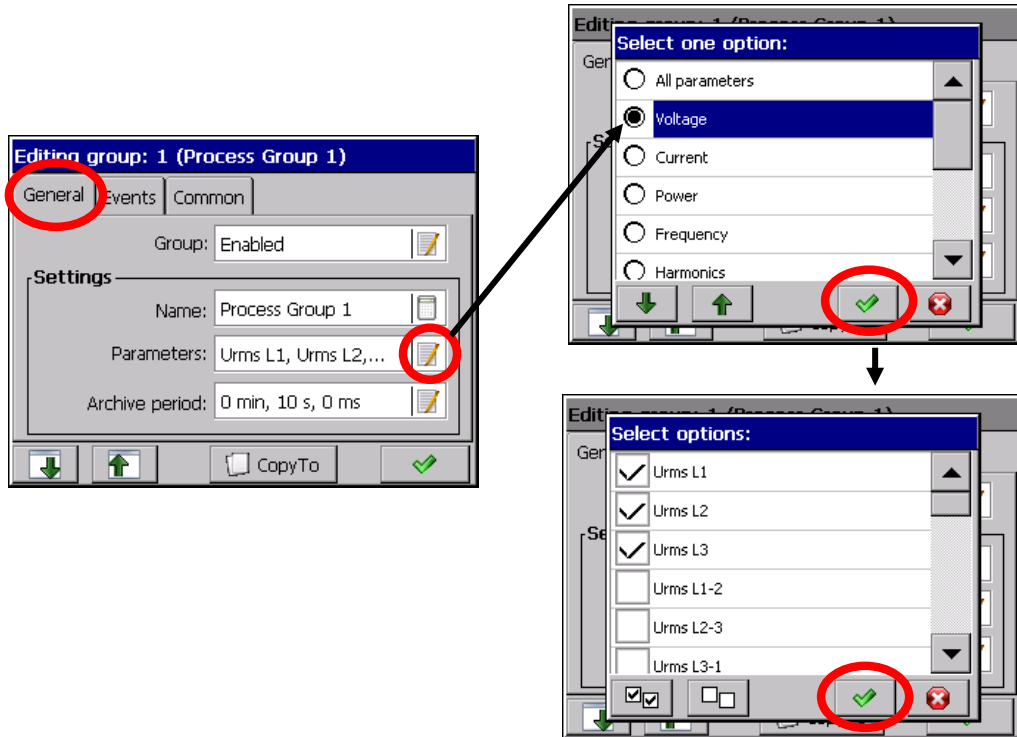

In the Events tab, you can select binary inputs which the state has an influence on the activation or disabling of the given event.

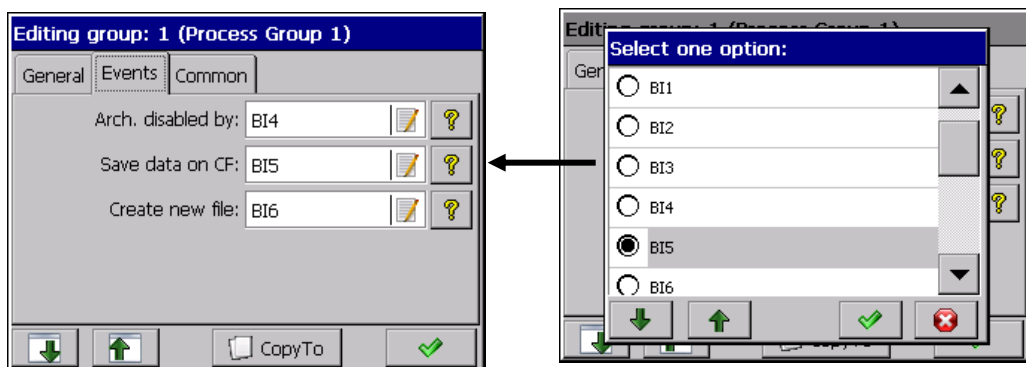

Arch. disabled by	When the selected binary input is in the logic state 1, the archiving is disabled
Save data on CF	When a change of the logic state follows from 0 on 1, on the selected binary input, the saving of newest data on the CF card will be forced.
Create new file	When a change of the logic state follows from 0 on 1, on the selected binary input, a new file with data is created.

In the **Common tab**, you can select events that are common for all enabled groups.

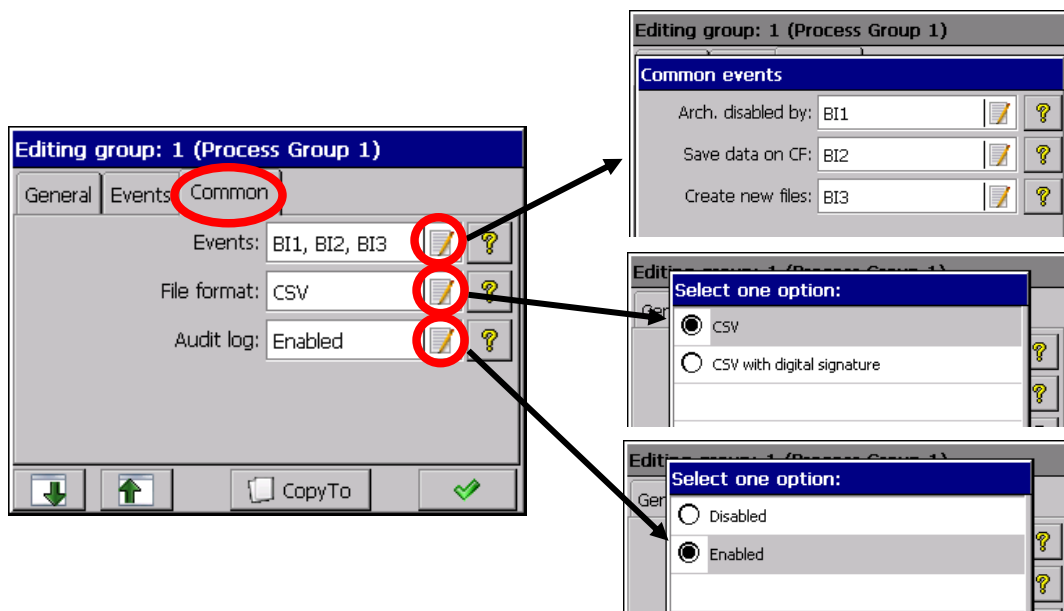

Archiving of measuring data switching off	The archiving is switched off when the selected binary input is in the logic state 1.
Data storage in a CF card	Data are stored in CF card at the moment of the logic state change selected from 0 into 1. The newest data are stored on the CF card.
Edition of a new file with measuring data	The activation follows at the moment of the selected source logic state change from 0 into 1.
Selection of file format	CSV or CSV with digital signature.
Archiving of the audit log	When it is switched off, the log is internally buffered.

Data from particular groups are stored on the CF memory card in files of capacity up to 8 MB, in *.csv text format – without or with the digital signature. The *.csv text file is open by the MS Excel program or other.

The **Digital signature** is (encrypted) information enabling to check the credibility of stored data in the text format. After choosing „CSV with digital signature” of the file format storage, a 128-bit “digital signature” is stored in the file. Each, even accidental change of data will be indicated during the checking of files by the **KD Check** program.

Since the CSV text file includes a digital signature, every defined number of measurement series, the file area (line range from .. to) which includes errors, will be indicated. Other data, for which the program does not identify data inconsistencies with the signature, are credible and can be used.

7.8. Ethernet



After pressing the icon, the configuration window of **Ethernet** interface parameters becomes open.

Select the Access type to the WWW Server in the Ethernet configuration window, edit Device IP, Subnet mask address and Default gateway and enable or disable the DHCP communication protocol (Dynamic Host Configuration Protocol).

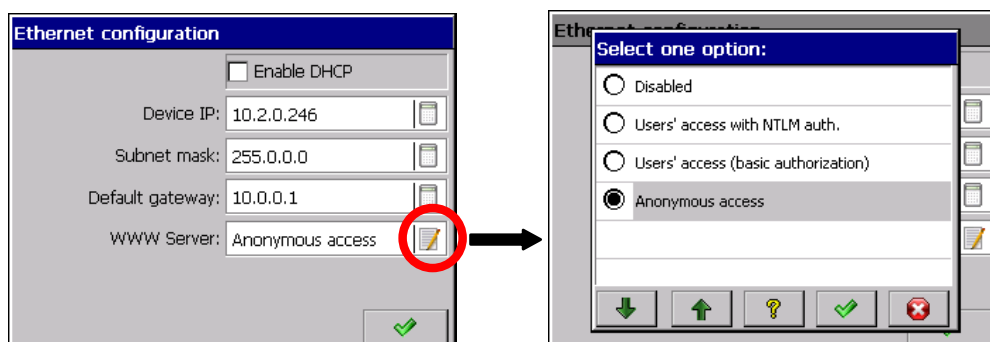

Access options to the WWW Server:

Anonymous access	It does not require a user's name and a password; anybody can be logged in to the analyzer WWW Server. This kind of access is not recommended for security considerations.
User's access (basic authorization)	Basic authorization type, it is required to give the user's name and the password before the logging in. This kind of authorization is available on the majority of platforms. It is recommended for compatibility issues.
User's access with NTLM auth.	It is the authorization protocol used in networks built on the base of the Microsoft® Windows NT® system (or newer). Recommended for users of these systems.

7.9. Modbus

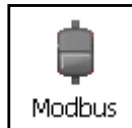

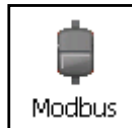
After pressing the icon  the configuration window of Modbus Master and Slave interface parameters and **Modbus Master CI1..24** input parameters are opening.

7.9.1. Configuration of Modbus Master

Item	Function
1	Selection of transmission mode: ASCII: 8N1,7N2, 7E1, 7O1 i RTU: 8N2, 8E1, 8O1, 8N1
2	Selection of baud rate: 300,600,1200,2400,4800,9600,14400,28800,38400, 56000,57600,115200,128000,230400,256000
3	Edition of the timeout
13	Setting acceptance

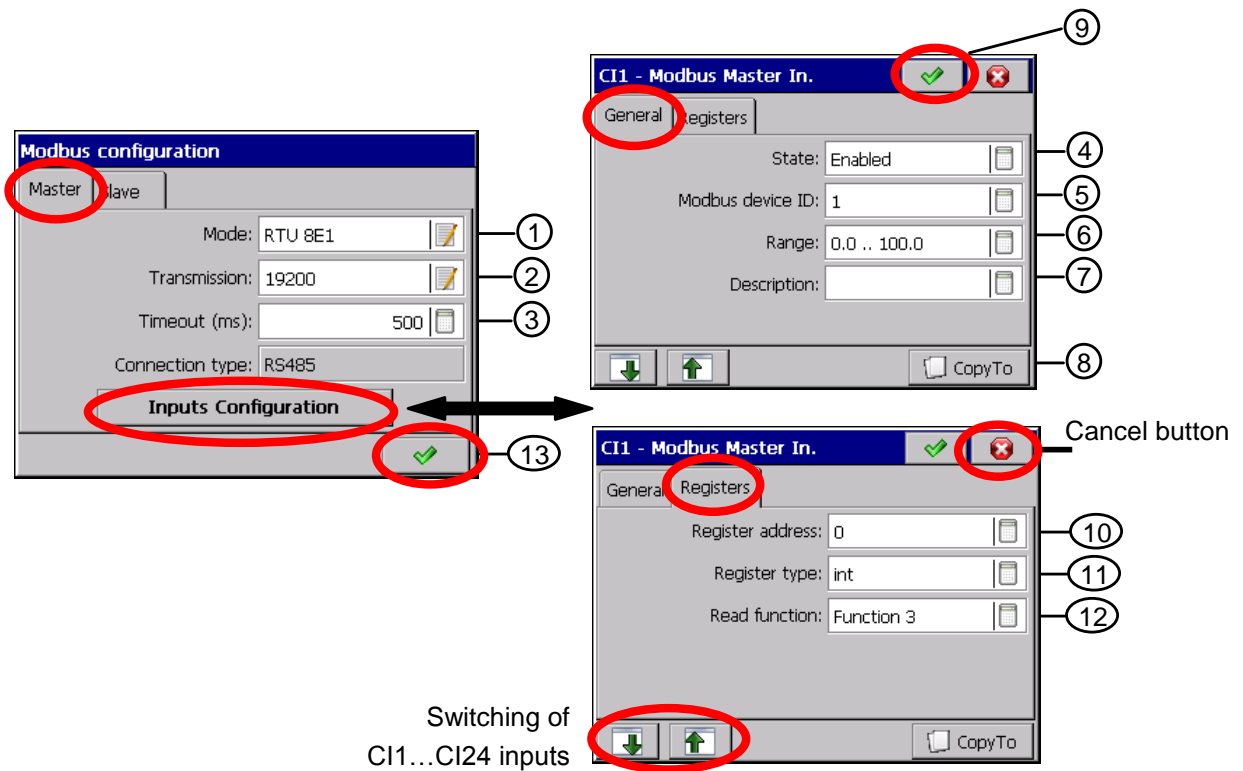

7.9.2. Configuration of CI1..24 interface inputs (General and Register)

Item	Inputs configuration: General
4	Selection: input<no.> Enabled or Disabled
5	ID edition of the Modbus device
6	Edition of the min-max range. Lower and upper limits
7	Edition of the Modus device description
8	Copying settings into another input
9	Acceptation of input settings/ interface input
Item	Inputs configuration: Registers
10	Address edition
11	Selection of the register type: char, int, long, float, float (bytes order:1234, 2143, 4321 or 3412)
12	Selection: Function 3 / Function 4
13	Setting acceptance

7.9.3. Configuration of Modbus Slave

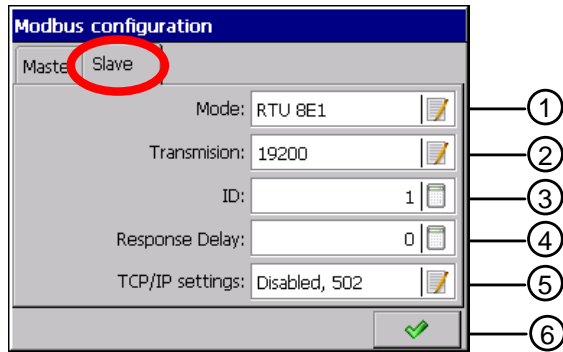

Item	Function
1	Selection of transmission mode: ASCII: 8N1,7N2, 7E1, 7O1 i RTU: 8N2, 8E1, 8O1, 8N1
2	Selection of baud rate: 300,600,1200,2400,4800,9600,14400,28800,38400, 56000,57600,115200,128000,230400,256000
3	ID edition (user's identifier)
4	Timeout edition
5	TCP/IP settings: Disabled / Enabled Port: 502
6	Setting acceptance

7.10. Security



After pressing the icon  the window of 1...8 analyzer user's edition and setting principles of their access to the analyzer configuration is becoming open. Only the user 1 (Admin) has assigned for good administrator authorization.

Only he can edit remaining users and change all their concerned settings. The user, who doesn't have administrator rights, can change only the access to the network, the name and password in the edition window.

When writing the password, it is recommended to take advantage only of Latin alphabet and Roman numerals, without using regional characters (after changing the analyzer menu language, the possibility to introduce individual password characters must be preserved).

Only the Administrator and Logged Users have access, after giving the password, to the option of analyzer parameter configuration in **ND1 Control Panel**.

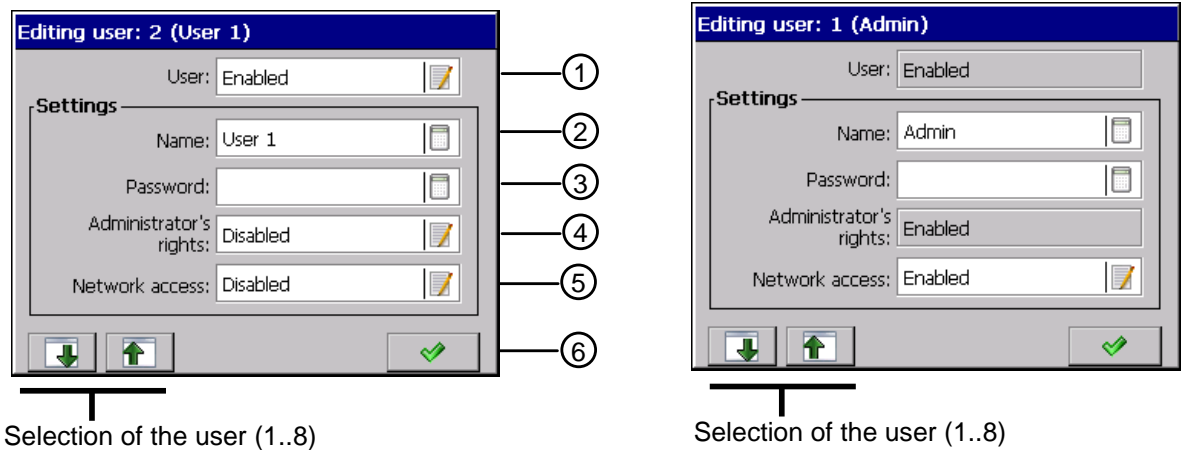

Item	Function
1	Enabling/Disabling of the selected user from 1..8
2	Edition of the user's name
3	Edition of the access code for changing the analyzer configuration
4	Enabling/Disabling of administrator rights for the given user
5	Enabling/Disabling access to the network for the given user
6	Setting acceptance

7.11. System information



After pressing the icon the window with information about the analyzer system, memory state, hardware installed in the analyzer, storage state of the CF memory card and internal buffer become open.

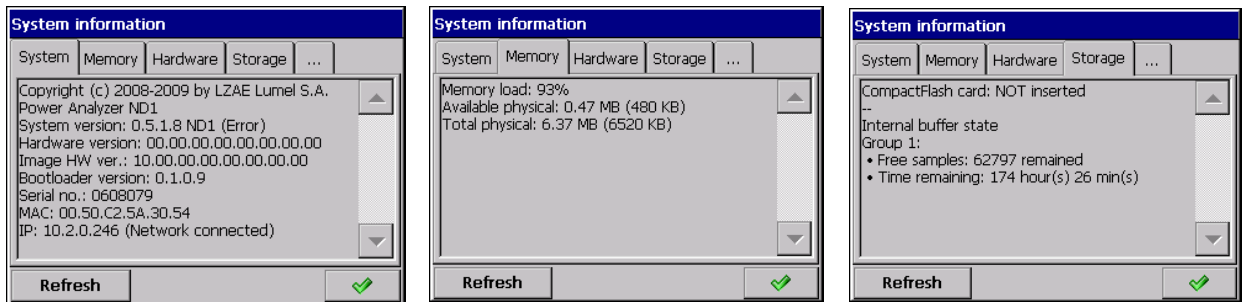

There is also the service tab of the analyzer program updating and the service maintenance. The service maintenance is only available for authorized users.

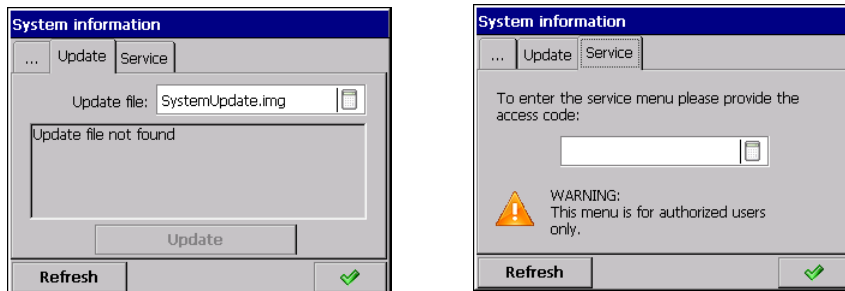

The procedure of the analyzer program updating is described in the section 8.3.

7.12. File Browser



After pressing the icon when the CF card is inserted in the analyzer, the file browser window becomes open. When there is no card, an appropriate message appears.

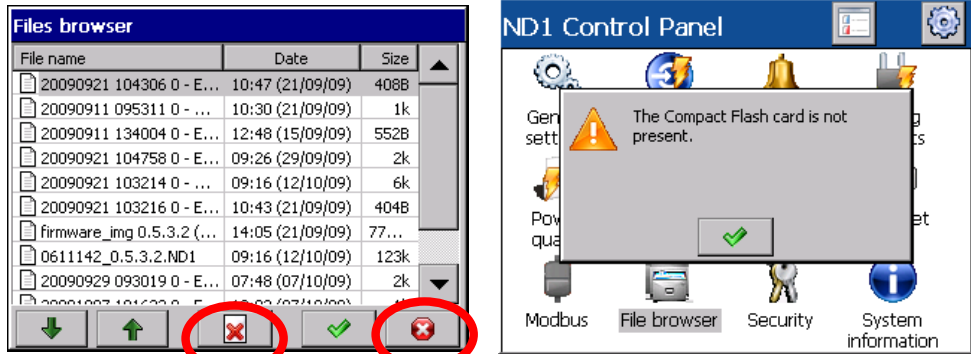

Delete of the marked file

Exit from the file browser

7.13. Events Logs

Following kinds of logs are available in ND1:

- Audit log
- Alarm log
- Energy log
- Power Quality log
- Dips and Swells log

Information concerning elements of the current analyzer service, kind of event, time and date of their appearance, are saved in **Audit Log**.

Audit log		30/06/09 14:48:28	
No.	Diary	Time	Date
4	Control Panel Closed (Admin)	14:48:11	30/06/09
3	Control Panel Opened (Admin)	13:13:09	30/06/09
2	Storage Card Inserted	07:52:49	30/06/09

User's messages, information about the alarm kind, sources of alarm signals, time and data of their occurrence are saved in **Alarm Log**.

Alarm log				
No.	Alarm tag	Source	Time	Date
12	Al. Max - On (230.2V)	Urms	13:30:46	25/06/09
11	Al. Max - On (230.2V)	Urms	13:30:46	25/06/09
10	Al. Max - On (230.2V)	Urms	13:30:46	25/06/09

The watt-hour meter state is saved periodically in **Energy Log**. If the save of active and/or reactive energy has been programmed in the **ND1 Control Panel - Inputs - Logs** menu then, these parameters will be displayed in the Energy Log.

Energy log				
No.	Log	Time	Date	
12	Periodic Call	12:00:00	29/06/09	▲
	E = 00000004.2 [kWh]			

Information about voltage and frequency quality parameters (defined in the EN 50160 standard) are saved in the **Power Quality Log**.

Power Quality Log				
No.	Log	Time	Date	

Information about Wells and dips (defined in the EN 50160 standard) are saved in the **Dips & Swells Log**. Phase on which a decay or voltage dip occurred is marked by the (•) point symbol.

Dips & Swells Log				
No.	Log	Time	Date	

Log parameters are programmed in the ND1 Control Panel menu:

Inputs – Logs tab:

- Active energy log: Enabled / Disabled
- Reactive energy log: Enabled / Disabled
- Energy log update

Alarms - Alarm[n] – *Control* tab:

- Alarm log: Enabled / Disabled

Visualization – *Logs* tab:

- Audit log size
- Alarm log size
- Energy log size
- Power Quality log size
- Dips log size

Archivization – *Common* tab:

- Audit log: Enabled / Disabled

7.13.1. Browsing and Handling of Event Logs

After pressing the screen during the visualization of measuring data, the **Context Menu** is displayed.

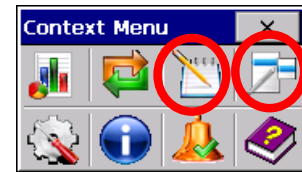

The pressure of  the icon generates the display and switching the view of successive logs.

The suitable log can be also selected in the selection option window displayed after pressing the  icon on one of the log screen information bar.

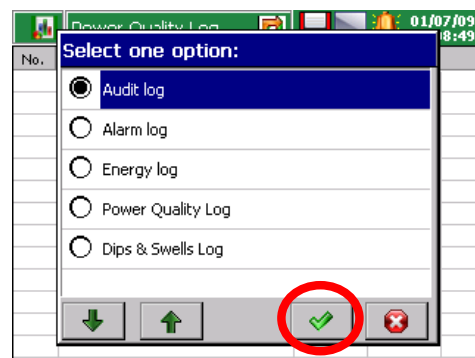
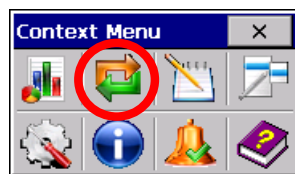



The pressing of the icon in the Context menu  during the browse of any log, generates the display of the screen from the service menu: **Reset this log / Reset All logs / Statistics ... / Confirm alarms.**

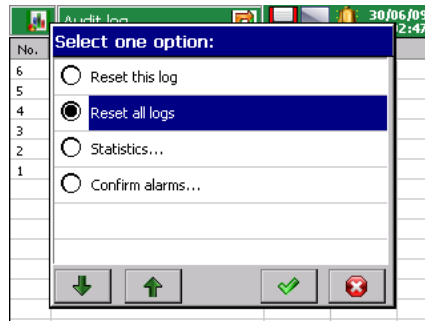

The execution of each option follows after the previous confirmation of the user's password. (if exists).

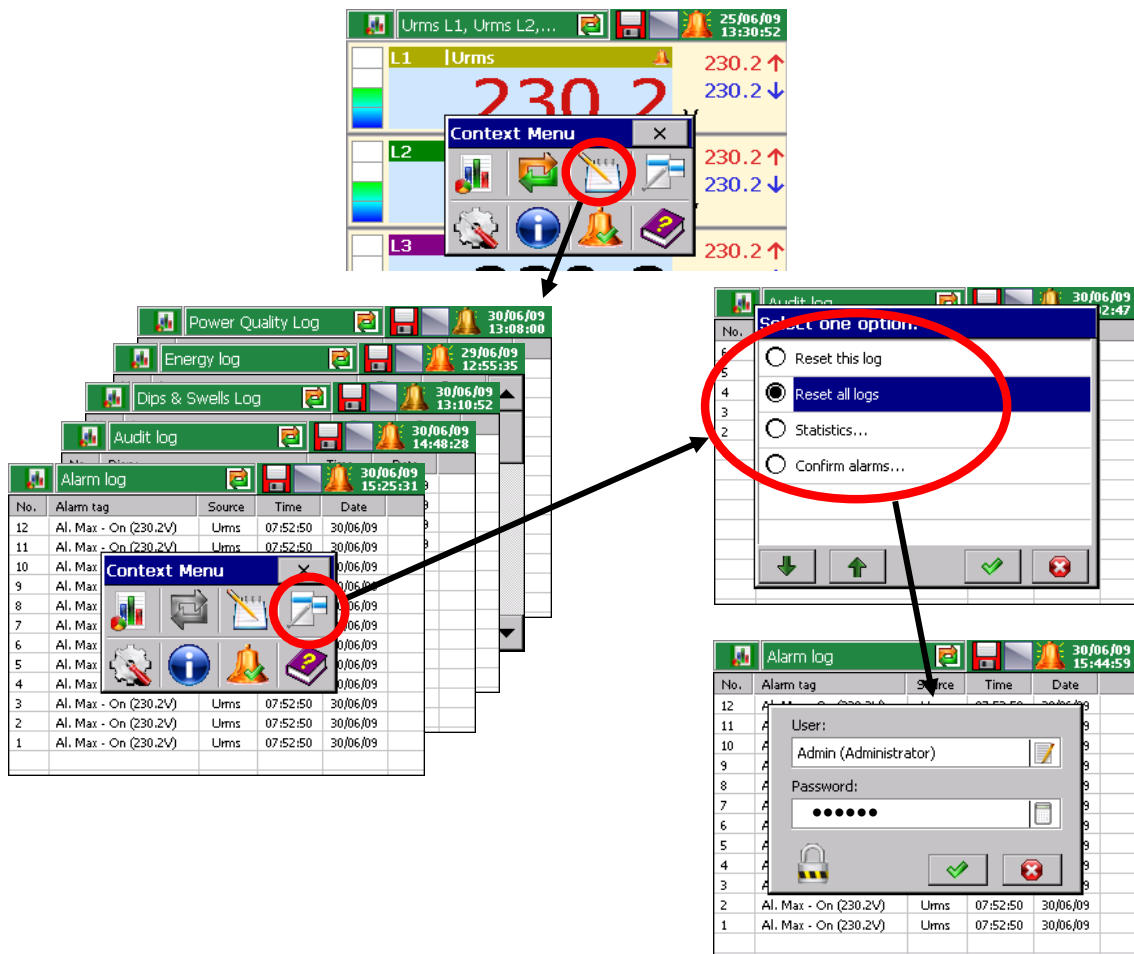

The selection of the **Reset this log** or **Reset All logs** option, cancels the currently displayed log. User's authorization is required to perform these operations. Similarly, **"Statistics..."** category may be chosen from the Context Menu. The following option is available **Reset all statistics**, which reset all min and max of all measuring values.

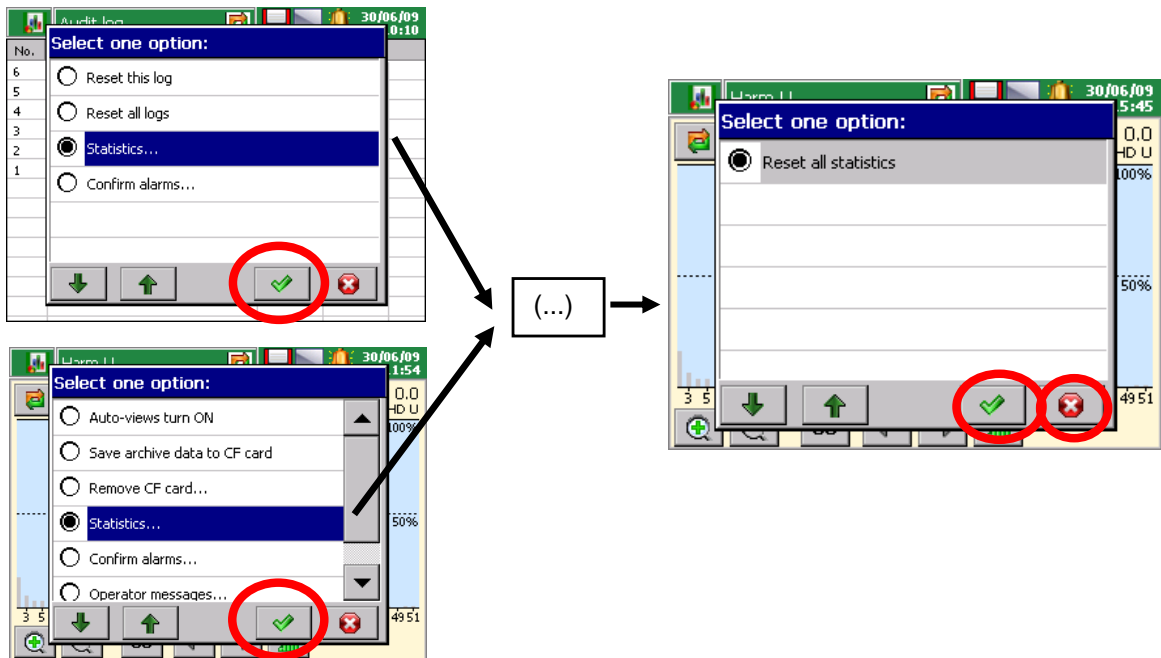

7.14. Edition of User's Messages

You can program in the analyzer configuration menu for the given measuring process up to 10 messages. The change of message content is only possible from the level of the analyzer configuration menu. However, a user has still the possibility to create its own message while inserting a new one from the Context Menu.

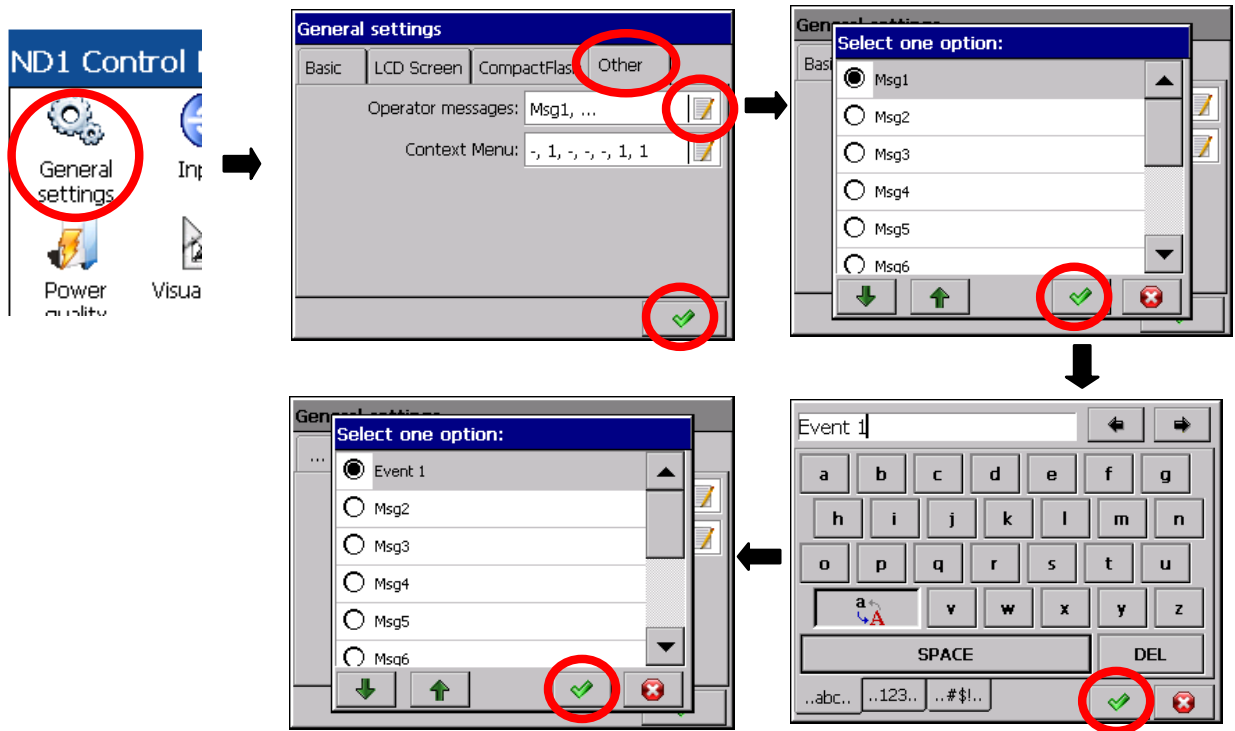

As the need arises, defined messages as above can be saved by the operator in the alarm log during the analyzer operation.

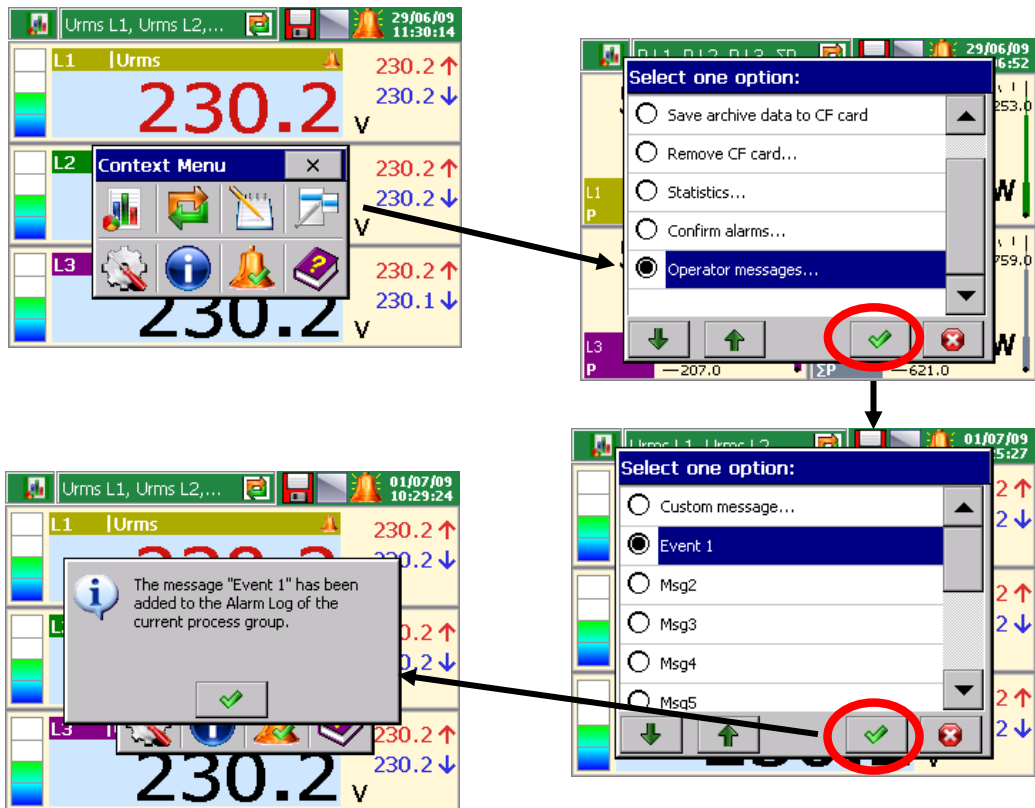

7.15. Exit from the Analyzer Configuration

After finishing the analyzer configuration you must close **ND1 Control Panel**.

After pressing the configuration exit push-button, the selection window of the configuration file storage option becomes open:

- after selecting the **Save and set configuration** push-button
- when simultaneously the **Export to file** option is checked, the configuration file will be saved in the analyzer memory and in the CF card, in the file named on the window. The name can be changed to another, after the entry to its edition. You can select any configuration file from stored in the CF card and under its name store a new configuration file.
- after pressing the **Leave without changes** button, changes carried out in the control panel menu are not stored, the analyzer programming state remains without changes.

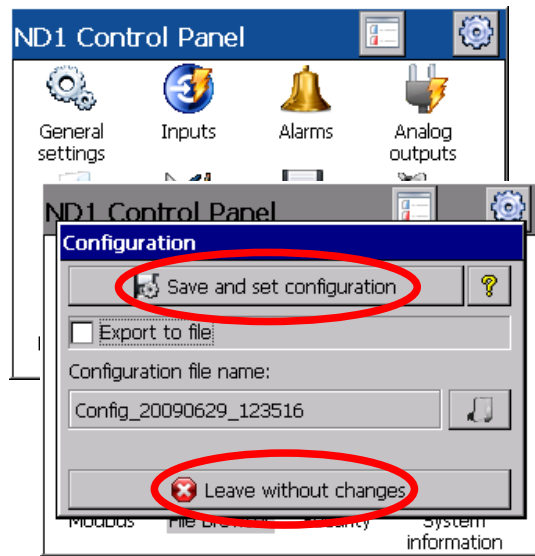

Notes:

1. One can set parameter configuration in the analyzer for various processes and store for them own configuration files (with own names). Applying them, you can quickly adapt the analyzer for current user's needs.
2. Configuration files for the given ND1 analyzer can be also prepared in the PC computer by the **ND1 Setup** program (see section 9.2), taking advantage of another configuration file from the **same analyzer**.

8. Selected Elements from the Current Analyzer Operation

8.1. CompactFlash Memory Card

For data storage in the ND1 analyzer, you can use CompactFlash memory cards of capacity up to 4 GB. It is recommended to use CompactFlash cards from the SanDisk® company.

8.1.1. Information about CF Card



After selecting the icon in the ND1 Control Panel window, the information about CF appears. If a CF card is not present an appropriate message is given in the Storage tab. When the card is inserted in the analyzer, the following parameters are showed: data about its used and free space, and the total capacity of the card.

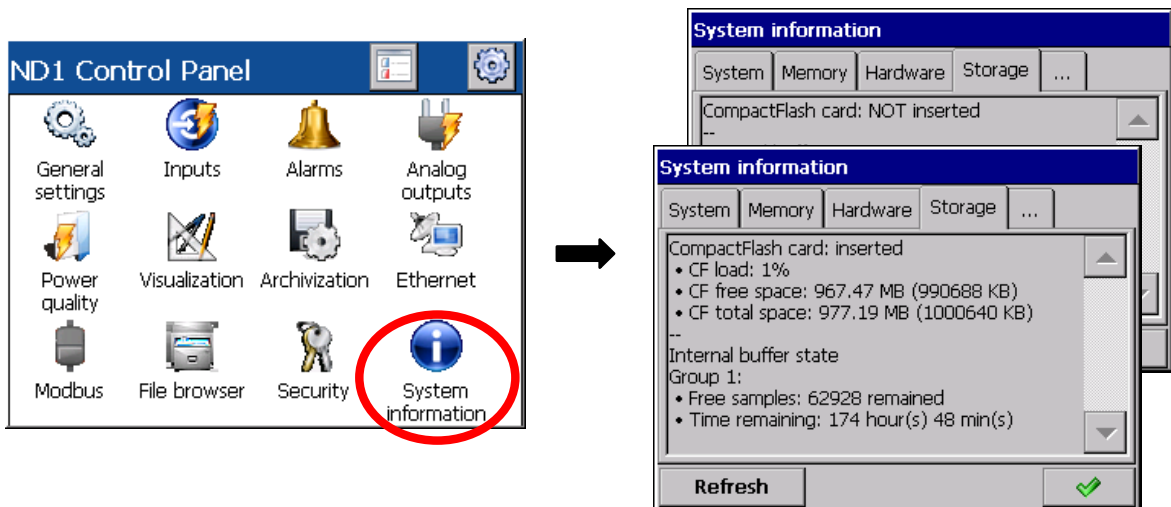

8.1.2. Formatting the CF card



After selecting the icon in the ND1 Control Panel, you can select options of **formatting functions** in the **CompactFlash** tab: **Quick Format** or CompactFlash **Full Format**. After the selection confirmation, the procedure of memory card formatting begins.

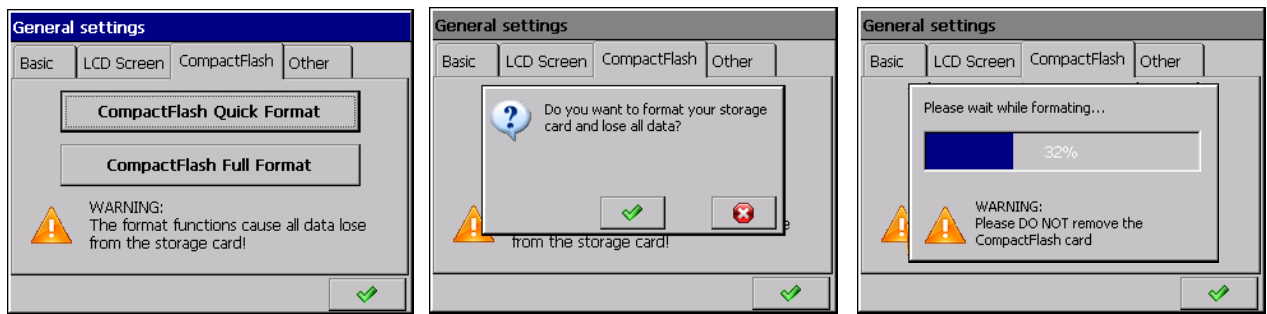

CompactFlash Quick Format	erases all files from the card but it does not scan the card in the aim to find damaged sectors. The option of quick formatting should be selected when the card was already formatted and we are sure it is not damaged.
CompactFlash Full Format	erases all files from the card and prepares the card to store information on it. The following operations are performed: checking the current card state, division of physical and logic card area into sectors, appropriate names are given to them and a system of files is created.

During the formatting of the CF card, the LED diode on the analyzer frontal plate changes the green color **into red**.

8.1.3. Data storage on the CF Card

During the analyzer operation, when measuring data are stored in its memory, the LED diode on the frontal plate **lights in green**. When data from the analyzer memory are saved on the CF card, the LED diode on the frontal plate changes its **color into red**.

Caution!



During data saving on the CF card, one **must not** pull it out from the analyzer. The removal of the card can cause an irreversible loss of all data stored in the memory card. One can remove the card only after finishing the data storage on it (green color of the LED diode).

When making changes in the analyzer configuration, all data from the buffer (stored in it at the original configuration) are saved to the hereto open files with data, and new data obtained already after introducing changes in the configuration, are stored in new files.



After exceeding 90% of the CF card capacity storage level (when the icon of the CF card on the ND1 screen has the red color) it is recommended to transfer data from the memory card to the PC computer as fast as possible, format the card or replace it for another empty one.



Caution!



After exceeding the nominal capacity of the CF card, measuring data will be stored in the ND1 buffer. During the data storage into the buffer, one must replace the CF card by another, formatted card. If the card is not replaced on time after filling the buffer, new data will be lost.

Note:

Using the KD Connect program, you can copy data to the PC, from the inserted CF card in the analyzer and perform its full erasing.

Data are not saved on-the-fly on the CF card because of possible quick card damage. The period of data storage from the given measuring group in the CF card is a multiple of the programmed storage period for this group and can last even several months.

For this reason, when in the meantime it is necessary to access the CF card data with all current measuring data, before its removal from the analyzer, select the option **Save archive data to CF card**. This operation copies all current data from the internal buffer into the CF card.

After selecting the option **Remove CF card** the copying of current data on the CF card follows and information about the possibility of a secure CF card removal and the insertion of a new one is displayed.

8.1.4. Visualization on the CF Card State on Screens

- Lack of CF card in ND1

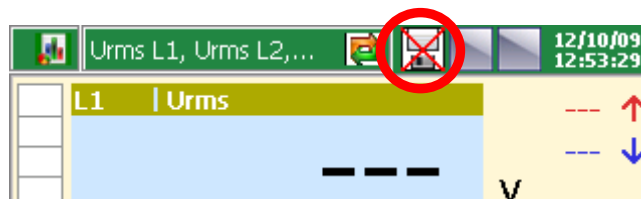

- The CF card is inserted in ND1, The data save lasts.

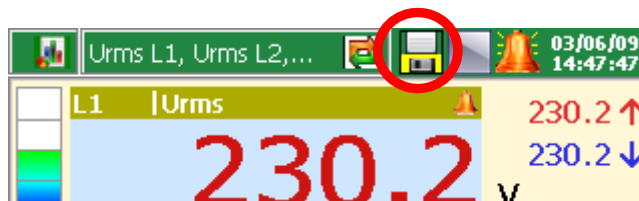

- The CF card is filled (over 90% capacity)

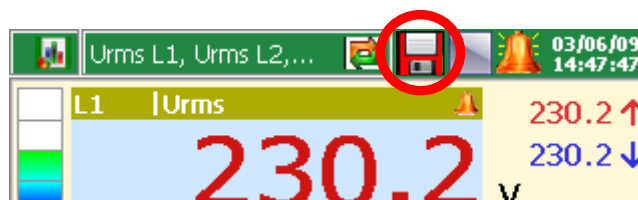

8.1.5. Browsing and Erasing of files from the CF Card



After selecting the icon in the ND1 Panel Control, file names saved in the CF card are displayed in the file browser. After selecting the given file and confirming its selection, it may be deleted from the CF card.

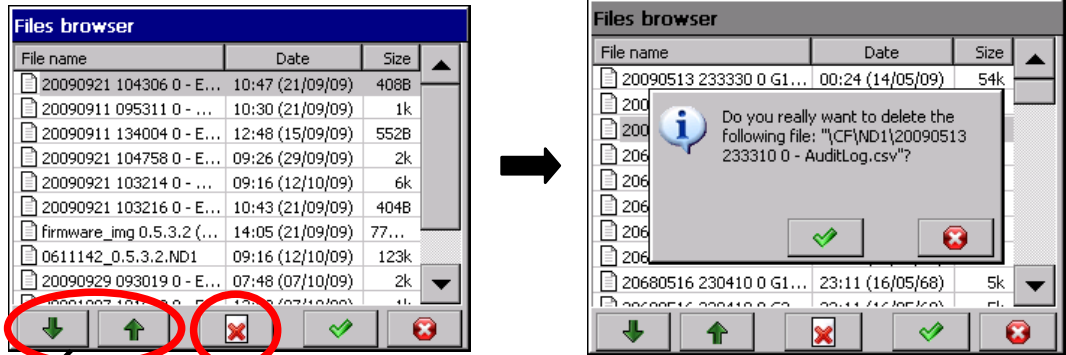

File selection

Delete of selected file

Exit from the menu return to the ND1 control panel

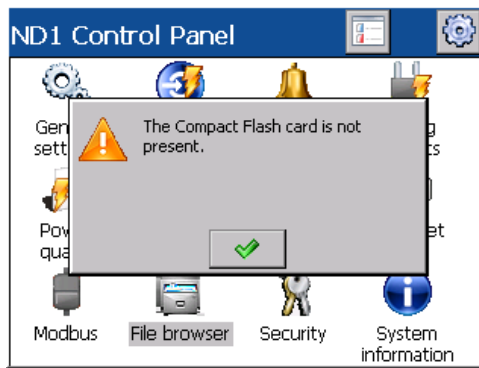

If the card is not inserted into the analyzer or it is not formatted, a message informing about its lack is displayed.

8.1.6. Removing CF Card, Exchange of CF Cards, Write of Archive Data

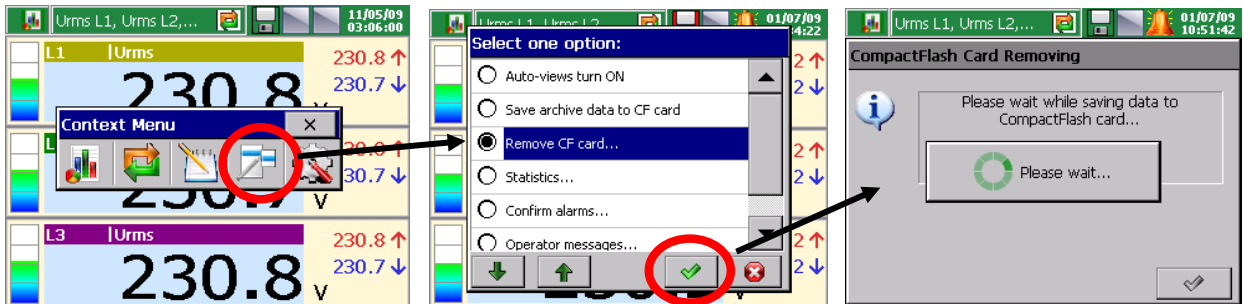

If you want to remove the CF card from the analyzer (without the accidental possibility of losing measuring data), you must open the context Menu window (by touching the screen with a finger), press the option selection  icon and in the open select option window, mark **Remove CF card**.

After selecting this option, data on the card will be completed with new data. Still the recording is performed in the internal buffer, while the save on the CF card is locked till the time of the displayed message acceptance.

Before the message acceptance, you can replace the CF card by a new one.

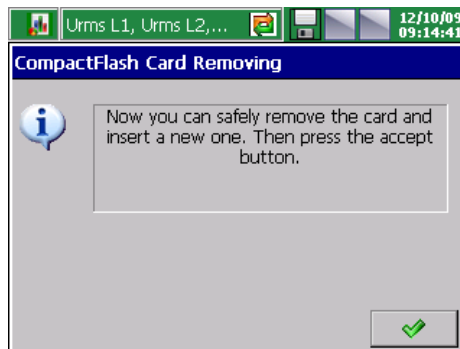

Caution!



The removal of the CF card, without the execution of the previously described procedure above, **can cause the loss of measuring data!**

The option **Save archive data to CF card**, forces the copying of the newest data from the analyzer internal memory (data Buffer) to the CF card. After the copying of archived data to the CF card, the recording into the buffer is continued in accordance with current settings.

Note: Considering the CompactFlash card life guaranteed by producers, a too often use of the saving data recording on the card is not recommended.

8.2. Touch Screen Calibration



After selecting the icon in ND1 Control Panel window, the Touch Screen calibration procedure is available on the LCD Screen tab of the General settings window. The calibration of the touch screen must be carried out in case of incorrect reaction on pressing the icons/buttons in windows displayed on the LCD screen.

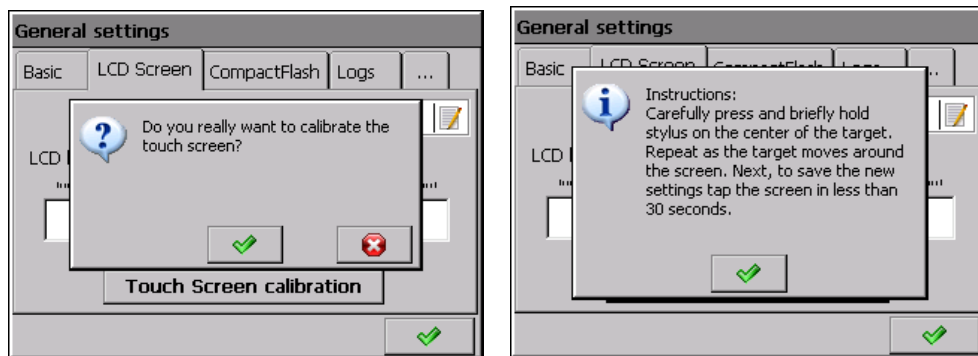

After pressing this option and confirming the selection and reading the short guide, the calibration window appears. Calibration procedure is based on successive pressing five calibration markers (crosses). In order to save introduced changes please touch the screen (any place) in a 30 seconds' period from the last touched marker.

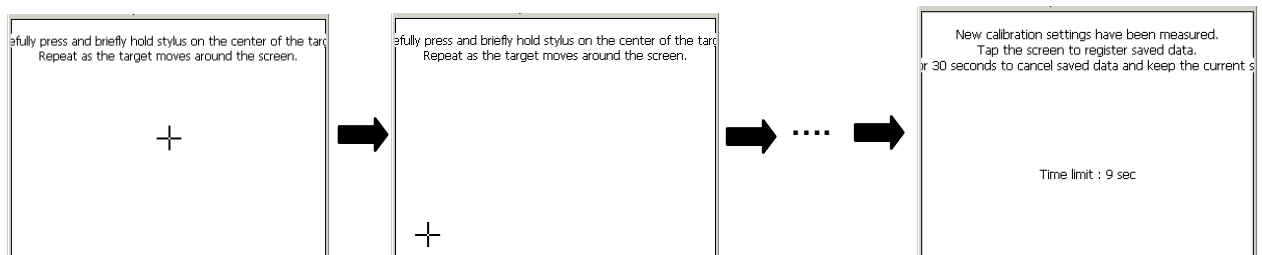

If the screen will not be pressed during the 30 seconds' period, changes in calibration will not be introduced.

8.3. Updating the Analyzer Program

After selecting the System information icon and then choosing the Update tab, the updating procedure of the ND1 analyzer is available.

Taking into consideration users' opinions about the ND1 analyzer, and as development works will be conducted in the company, the ND1 analyzer will be updated. New firmware and software versions, in the form of updated files will be available for interested users on the page: <http://www.lumel.com.pl/>.

After copying the new update file to the ND1 directory on the CF card (e.g. taking advantage of the KD Connect program), you can update the analyzer firmware. In order to do that, you must carry out the following operations (from the **Control Panel – System Information – Update** tab):

Select the updating file in the window of the file browser

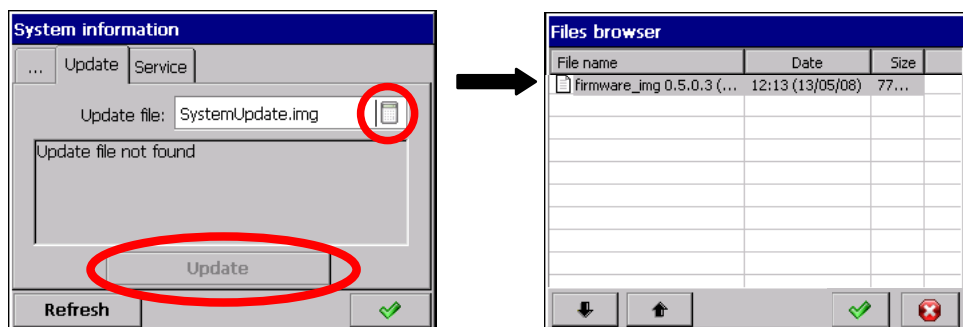

Accept the selection and press the Update button.

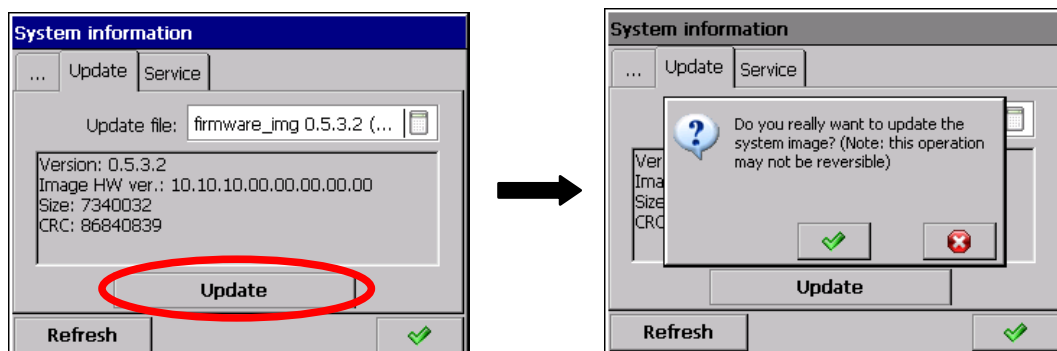

After confirm the choice, the updating starts and after it finishes, a result message is displayed:

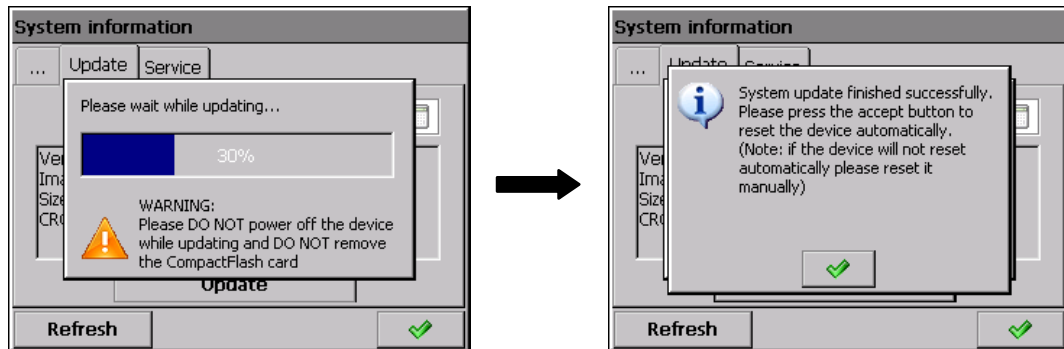

After finishing the firmware update, the automatic conversion of the analyzer configuration follows (automatic configuration storage in the file before execution of the program update and its automatic readout after the updating execution. So please **DO NOT** take the CF Card off the analyzer).

Caution!



During the system updating, **one must not switch the analyzer off and one must not take the CompactFlash card out.**

8.4. Maintaining Data Stored on the CF Card, Visualization

Measuring data, separately from each group of logic channel, are stored in text format files *.csv with or without the digital signature. The **KD Check** program is designed to check the digital signature of a data file. The limitation of the file capacity is up to 8 MB. The format enables a direct browsing and visualization of data stored in the text format *.csv, e.g., in the MS Excel program.

Data from the memory card can be copied to a PC computer using the memory card reader servicing cards of CompactFlash type or taking advantage from features of the KD Connect program added to each delivered analyzer.

The **KD Connect** program is destined for the communication between the PC computer and the ND1 analyzer by means of the USB interface. It enables to carry out following operations:

- copying files from the CompactFlash card, directly from the analyzer on the PC computer (e.g. data files, screen dumps),

- uploading files from the PC computer on the CompactFlash card in the analyzer (e.g. file with an ND1 firmware),
- deleting of stored files in the analyzer CompactFlash card,
- collection of current system information of the ND1 analyzer (among others: system version, current configuration, level of CompactFlash card filling).

The **ND1 Setup** program enables to prepare in the PC a configuration file for the ND1 analyzer. The appearance and operating the ND1 Setup program are the same as to the analyzer menu described in the user's manual. But please take notice of some differences:

- to handle the **ND1 Setup** program, the mouse and computer keyboard are used
- dialogues of file selection allow to browse the contents of computer disks
- the language of the **ND1 Setup** program is compatible with the language of the last edited configuration
- the appearance of dialogue windows highly depends on the system user interface customization (as e.g.: the size of system fonts).

The result of work with the **ND1 Setup** program is the configuration file for an analyzer of a defined hardware configuration.

9. Programs on the PC

9.1. KD Connect Program

The **KD Connect** application is destined for the communication between the PC computer and the ND1 analyzer using the USB interface.

The **KD Connect** program enables to carry out following operations:

- copying of files from the CompactFlash card, directly from the analyzer into the PC computer (e.g. data files, screen dumps),
- uploading of files from the PC computer into the CompactFlash card in the analyzer (e.g. file with the updated ND1 program),
- deleting of stored files in the analyzer CompactFlash card,
- reading the current system information of the ND1 analyzer (among others, system version, current configuration, level of the CompactFlash filling).

9.1.1. Installation of the USB Driver

To make connection between the ND1 and a PC you have to install the driver in under the MS Windows operating system.

After connecting the Analyzer to the USB port of your PC, the operating system will ask you for necessary drivers (“**Found New Hardware Wizard**” appears).

Insert the CD disk delivered with the ND1 analyzer into the CD-ROM drive.

Select the option “**Install the software automatically (recommended)**” and click “Next”.

Select the found driver from the list and press “Next” to install the driver by the wizard. Windows will locate the drivers and proceed with the installation. When the wizard informs about the lack of driver compatibility tests with MS Windows, answer “**Continue Anyway**”. Next, click the push “**Finish**”.

After the correct driver installation (a restart of the system is not required) you can start to install programs delivered with the ND1 analyzer.

Select the folder with the **KD Connect** program on the CD disk and start the **KD Connect_install.exe** program. The installation wizard starts. Proceed in compliance with instructions displayed on the screen.

Software Requirements:

- operating system: MS Windows 2000 or better,

- USB drivers for ND1,
- 3 MB of free space on a hard disk
- other requirements same as operating system's ones.

Software Instalation

The program installation is typical for applications destined for the MS Windows environment. The program installation is available in the annexed CD disk, in the “**KD Connect**” directory.

9.2. ND1 Setup Application

ND Setup is a program enabling to prepare a configuration file in the PC for the ND1 analyzer. After recopying the configuration file on the CF memory card, it can be used for reprogramming settings in the given ND1 analyzer.

Installation

The program installation is typical for applications destined for the MS Windows environment. The installation program is located on the annexed CD disk to the analyzer, in the “**ND Setup**” folder. To begin the program installation, start the installation program **ND Setup_install.exe**. Next, proceed according to messages appearing on the screen.

9.3. KD Check Application

The KD Check program is destined for digital signature verification of measuring data saved in the CSV format. The program installation is typical for application destined for the MS Windows environment. The installation program is situated on the CD added to the delivered analyzer. To begin the program installation, start the **KD Check_install.exe** installation program. The installation wizard starts. During the verification of files, proceed acc. to the instructions displayed on the screen.

10. Technical Data

Measuring ranges and admissible basic conversion errors

Measuring quantity	Range	Basic error	Remarks
Voltage U	57.73 / 100.0 V (Ku = 1) 230.0 / 400.0 V (Ku = 1) 400.0 / 690.0 V (Ku = 1) 400.0 kV (Ku ≠ 1)	± 0.2 %	Ku = 1...4000
Current I	1.000 A (Ki = 1) 5.000 A (Ki = 1) 100.0 kA (Ki ≠ 1)	± 0.2 %	Ki = 1...20000
Active Power P Mean Active Power Pav	0.0... (-) 6000.0 W 999.00 MW (Ku ≠ 1, Ki ≠ 1)	± 0.5 %	
Apparent Power S	0.0...6000,0 VA 999.00 MVA (Ku ≠ 1, Ki ≠ 1)	± 0.5 %	
Reactive Power Q	0,0...(-) 6000.0 var 999.00 Mvar (Ku ≠ 1, Ki ≠ 1)	± 0.5 %	
Active Power Factor PF	-1.000...0...1.000	± 0.5 %	PF = Power Factor = P/S
Coefficient tgφ	-10.00...0...10.00	± 1 %	Ratio of active power to reactive power
φ angle between I and U	-180°...180°	± 0,5 %	Evaluated from the power triangle
Frequency f	45.00...66.00 Hz	± 0.1 %	
THD U, THD I Harmonics U, I (up to 51)	0...200.0 % 0...100.0 %	± 2 %	Error in the range 10...120 % U,I for 50 Hz
Active energy EnP	0...(-) 99 999 999.9 kWh	± 0.5 %	
Reactive energy EnQ	0... (-) 99 999 999.9 kvarh	± 0.5 %	

where

Ku	voltage transformer ratio
Ki	current transformer ratio
THD U	total coefficient of voltage harmonic distortion
THD I	total coefficient of current harmonic distortion

Technical parameters of measuring input	
no. of inputs	7, galvanically isolated
resolution of A/D converter	16 bit
sampling rate	6250 S/s on each channel simultaneously
measuring band	3 kHz (for U and I measurement)
harmonic measurement	up to 51'st
isolation	3.1 kV d.c.
measurement time	1 s

Dips, swells and interruptions	
U RMS A/C	0,0...200,0 % accuracy $\pm 0,5$ % from nominal value event detection based upon 1 cycle RMS voltage programmable thresholds in percent of nominal voltage

Additional conversion errors (in % of the basic error)	
from ambient temperature changes	< 100 % / 10 °C

Analog outputs	
current:	4, galvanically isolated
output signal	0...20 mA
basic output error	0.2 %
load resistance	$\leq 500 \Omega$
isolation	500 V d.c.
reaction time	100 ms

Binary inputs	12, with a common ground
control signal	0 / 5...24 V d.c.
switching frequency	starting 2 Hz
isolation	500 V d.c.

Alarms	Normally open (NO)
electromagnetic relays	6, programmable
contact voltage / load current	≤ 250 V a.c. / 1.5 A ≤ 30 V d.c. / 1 A
reaction time	100 ms + hysteresis delay

Interfaces	
2 × RS485 (Modbus Master & Slave)	Transmission rate: 300...256000 bauds Transmission mode: ASCII/RTU Reaction time: timeout
USB	V.1.1 Device, USB-B socket
Ethernet	10 Base-T, RJ45 socket, Modbus Slave TCP/IP, Web Server, NTP Client

General analyzer parameters	
graphic color screen	LCD 5.7" TFT, 320 × 240 pixels with touch panel
external data support	CompactFlash up to 4 GB
internal memory (buffer)	6 MB
power input	
supply circuit	≤ 28 VA
voltage circuit	≤ 0.2 VA
current circuit	≤ 0.2 VA
casing protection level	
from the frontal side	IP65 acc. to EN 60529
from the terminal side	IP20 acc. to EN 60529

Archivization	
Number of parameters possible to be archived (Event Logs not concerned)	48 (4 groups of 12 recorded and calculated parameters)
Archive period	from 100 ms up to 12 hours (separately for each group)
Events Logs	separate archivization of event logs: audit, energy, power quality, voltage dips, swells and interruptions. Over 50 various parameters.

Data recording area	internal Flash buffer, CompactFlash card
Formaty zapisu	CSV, CSV with digital signature
Others	<ul style="list-style-type: none"> - archive control of each group by binary inputs (possible events: storage control, creation of new files, internal data flush to CF), - giving a name for each data group, - access to stored data thru Web page and internal buffer flush to CF.

Reference and rated operating conditions	
operating temperature	0... <u>23</u> ...50 °C for < 75% relative humidity 0... <u>23</u> ...65 °C for < 40% relative humidity without condensation in both cases
storage temperature	-20...65 °C
supply	85...253 V d.c./a.c., 40...400 Hz
reaction against decays and supply recoveries	preservation of data and the device state during the decay, work continuation after the supply recovery
input signal	0... <u>0.005</u> ... <u>1.2</u> In, 0... <u>0.05</u> ... <u>1.2</u> Un for current and voltage; 0... <u>0.1</u> ... <u>1.2</u> In, Un for coefficients PF, tgφ; frequency 45... <u>50</u> ...66 Hz sinusoidal (THD ≤ 8 %)
power factor	<u>-1</u> ... <u>0</u> ... <u>1</u> C, L
admissible peak factor of	
measuring current	2
measuring voltage	2
frequency of the 1'st harmonic	from 47 to 52 Hz
short duration overload (1 s)	
voltage input	2 Un (max.1000 V)
current input	10 In

Mounting requirements	
dimensions of the frontal part	144 × 144 mm
length of the frontal part	155 mm
dimensions of the mounting hole	138 ⁺¹ x 138 ⁺¹ mm
moment value to tight up clamps fixing the analyzer	0.2 Nm

Service safety		acc. to EN 61010-1, basic isolation
installation category		III
pollution level		2
Working voltage related to earth		
RS485, USB interfaces		50 V
measuring system		500 V <i>cat. III</i> for 57.7 V / 100 V and 230 V / 400 V options, <i>cat. II</i> for 400 V / 690 V option
electromagnetic relays, supply		300 V
altitude ASL		< 2000 m
Electromagnetic compatibility		
noise emission		acc. to EN 61000-6-4
noise immunity		acc. to EN 61000-6-2
Auxiliary supply		2 × 24 V d.c. / 30 mA ±5%
Other		
Weight		< 2 kg

11. Order Codes

Power Quality Analyzer	ND1 –	X	X	XX	X	X
Current input:						
1 A	1					
5 A	2					
Voltage input:						
57,7 V / 100 V	1					
230 V / 400 V	2					
400 V / 690 V	3					
Version:						
standard	00					
custom-made ^(*)	XX					
Language:						
Polish	P					
English	E					
other ^(*)	X					
Acceptance tests:						
without extra requirements	0					
with an extra quality inspection certificate	1					
acc. to customer's request ^(*)	X					

^(*) after agreeing with the Manufacturer

Note: The ND1 analyzer is equipped with **6 alarms** (electromechanical relays), **4 analog outputs** and **12 binary inputs**.

EXAMPLE OF ORDER

The code **ND1-2-1-00-E-0** means:

ND1	Analyzer of three-phase power network parameters of ND1 type
2	current input: 5 A
1	voltage input: 57.7 V/100 V
00	version: standard
E	English version
0	without extra requirements

Maintenance and Guarantee

The ND1 Power Analyzer does not require any periodical maintenance. In case of some incorrect unit operations:

From the Shipping Date, During the Period Given in the Annexed Guarantee Card

One should take the instrument down from the installation and return it to the Manufacturer's Quality Control Dept. If the instrument has been used in compliance with the instructions, the Manufacturer guarantees to repair it free of charge.

After the Guarantee Period

One should turn over the instrument to repair in a certified service workshop. The disassembling of the housing causes the cancellation of the granted guarantee.

The Manufacturer's policy is one of continuous improvement and we reserve the right to make changes in design and specifications of any products as engineering advances or necessity requires and revise the above specification without notice.

CONTROL - MEASUREMENT - RECORDING



SALES PROGRAM

- DIGITAL and BARGRAPH PANEL METERS
- MEASURING TRANSDUCERS
- ANALOG PANEL METERS (DIN INSTRUMENTS)
- DIGITAL CLAMP-ON METERS
- INDUSTRIAL PROCESS and POWER CONTROLLERS
- CHART and PAPERLESS RECORDERS
- 1-PHASE and 3-PHASE WATT-HOUR METERS
- LARGE SIZE DISPLAY PANELS
- ELEMENTS OF INTEGRATION SYSTEMS
- ACCESSORIES for MEASURING INSTRUMENTS (SHUNTS)
- CUSTOM-MADE PRODUCTS ACCORDING CUSTOMER'S REQUIREMENTS

WE ALSO OFFER OUR SERVICES IN THE PRODUCTION OF:

- ALUMINIUM ALLOY PRESSURE CASTINGS
- PRECISION ENGINEERING and THERMOPLASTICS PARTS
- SUBCONTRACTING of ELECTRONIC DEVICES (SMT)
- PRESSURE CASTINGS and OTHER TOOLS

QUALITY PROCEDURES

According to ISO 9001 and ISO 14001 International Requirements.

All our instruments have CE mark .

For more information, please write to or phone our Export Department

Lubuskie Zakłady Aparatów Elektrycznych LUMEL S.A.

ul. Sulechowska 1, 65-022 Zielona Góra, Poland (EU)

<http://www.lumel.com.pl>

Export department

Tel.: (48-68) 329 53 02

Fax: (48-68) 325 40 91

e-mail: export@lumel.com.pl

© 2009 LZAE Lumel S.A., All right reserved.

ND1-09/1 (18.12.09)