

KD8 SCREEN RECORDER

FEATURES:

IP65



MOD BUS



- Intuitive servicing - LCD TFT 5.7" screen, with touch panel.
- Data archiving on CompactFlash card, capacity up to 4 GB.
- IP65 protection grade on the front panel.
- 3 or 6 analog programmable measuring inputs.
- 6 or 12 alarms outputs.
- 4 or 8 digital inputs.
- Visualization of measurements in digital form, analog indicators, diagrams, bargraphs.
- RS-485 and USB serial interfaces.
- MS Windows® CE operating system.
- PC softwares: KD8 SETUP, KD CHECK, KD CONNECT, KD ARCHIVE.
- Programmable events.
- Menu available in various language versions.

INPUTS:



OUTPUTS:



RS 485

USB

GALVANIC ISOLATION:



Digital interface

EXAMPLE OF APPLICATION

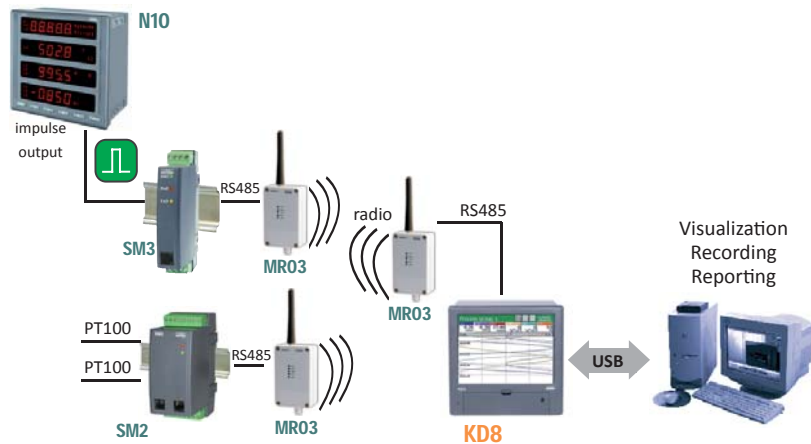

System of measurement, control and recording of temperature and energy with wireless communication.

EXAMPLES OF MEASURING DATA PRESENTATION

Various forms of data display:

- linear diagrams,
- digital indicators,
- analog views,
- bargraphs,
- tables and others. (manual and automatic switching between screens.)

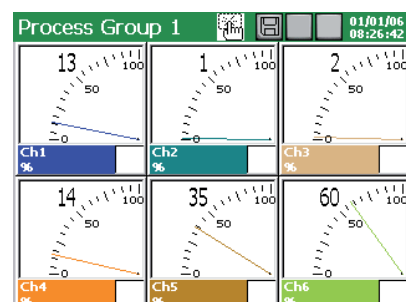
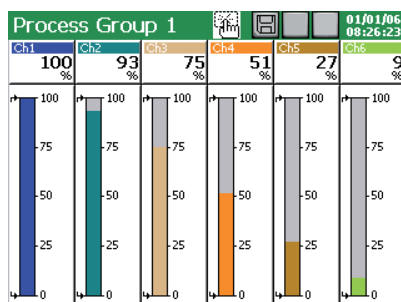
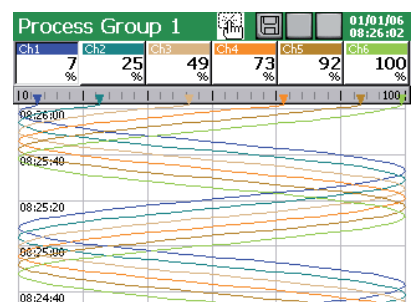
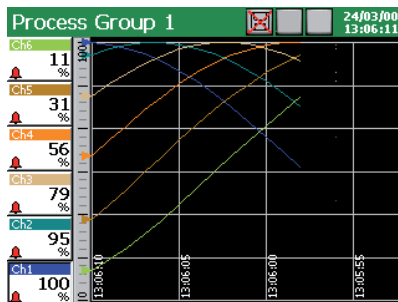

Export department:
 English: +48 68 32 95 302 / 321 / 276 / 386 / 233
 German: +48 68 32 95 305
 French: +48 68 32 95 304
 Russian: +48 68 32 95 321
 Fax: +48 68 32 54 091
 e-mail: export@lumel.com.pl
 LUMEL S.A.
 ul. Sulechowska 1
 65-022 Zielona Góra
 POLAND
 WWW.LUMEL.COM.PL

INPUTS					
Input signal	Measuring range/ Accuracy class (%)		Minimal subrange/ Accuracy class (%)		
Voltage	0 .. ±9999 mV	0.15	5 mV	0.25	
Current	0 .. ±20 mA	0.15	1 mA		
Thermocouple (TC): J (Fe-CuNi) K (NiCr-NiAl) N (NiCrSi-NiSi) E (NiCr-CuNi) R (PtRh13-Pt) S (PtRh10-Pt) T (Cu-CuNi) B (PtRh30-PtRh6) L (GOST) K (GOST)	-200 .. 1200°C	0.1	100°C	1	
	-200 .. 1370°C		130°C	0.7	
	-200...1300°C		200°C	0.5	
	-200...1000°C		100°C	1	
	0 .. 1760°C	0.2	540°C	0.3	
	0 .. 1760°C		570°C	0.3	
	-200 .. 400°C	0.1	110°C	0.9	
	400 .. 1820°C	0.2	1000°C	0.2	
	-200 .. 800°C	0.1	90°C	0.2	
	-200 .. 1370°C		130°C	0.7	
Resistance transmitter (RTD): Pt 100 Pt 500 Pt 1000 Ni 100 Cu 100 GR.21 (GOST'78) (GOST'94) 50P (GOST'78) (GOST'94) 100P (GOST'78) 100P (GOST'94) 50M (GOST'78) (GOST'94) 100M (GOST'78) (GOST'94) Potentiometric transmitter Resistance transmitter		0.15	50°C	0.25	
	-200 .. 850°C	0.3		0.5	
		0.3			
	-60 .. 180°C	0.15		0.25	
	-50 .. 180°C				
	-260 .. 1100°C				
50 .. 2000 Ω		100 Ω			
0 .. 2000 Ω		100 Ω			
Logic input	control signal 0/5 .. 24 V d.c.		switching frequency up to 50 Hz		

OUTPUTS	
Output type	Properties
Relay	- electromagnetic relays: ≤ 250 V a.c./1 A or ≤ 30 V d.c./1 A
Output to supply object transducers	- 2 outputs 24 V d.c./ 30 mA

DIGITAL INTERFACE	
Interface type	Properties
RS-485	interface: MODBUS Slave, baud rate 0.3 .. 256 kbit/s, transmission mode: ASCII/ RTU
USB	device V.1.1, socket USB-B

EXTERNAL FEATURES		
Supply voltage	90 .. 230 .. 253 V	input power ≤ 30 VA
Temperature	operating: 0 .. 23 .. 55°C	storage: -20 .. 60°C
Humidity	< 70%	condensation inadmissible

RATED OPERATING CONDITIONS		
Display field	LCD 5.7" TFT type	320 x 240 pixels, with touch screen
Overall dimensions	144 x 144 mm	panel cut-out dimensions: 138+1 x 138+1 mm
Weight	< 2 kg	
Protection grade	from frontal side: IP65	from terminal side: IP20

SAFETY AND COMPATIBILITY REQUIREMENTS		
Electromagnetic compatibility	noise emissions	acc. to EN 61000-6-4
	noise immunity	acc. to EN 61000-6-2
Isolation between circuits	500 V d.c.	acc. to EN 61010-1
Isolation between supply and measuring system	2 kV	
Pollution level	2	
Installation category	II	
Maximal operating voltage in relation to earth	for the measuring system, relays and supply: 500 V	acc. to EN 61010-1
Altitude above sea level	< 2000 m	

SOFTWARES ASSISTING THE KD8 RECORDER WORK:

KD ARCHIVE
Software destined to review and analyse archive data from the recorder on a PC computer, stored in a binary format with digital signature.

KD8 SETUP
Software destined to configure recorder settings by means of a PC computer.

Export department:
English: +48 68 32 95 302 / 321 / 276 / 386 / 233
German: +48 68 32 95 305
French: +48 68 32 95 304
Russian: +48 68 32 95 321
Fax: +48 68 32 54 091
e-mail: export@lumel.com.pl
 LUMEL S.A.
 ul. Sulechowska 1
 65-022 Zielona Góra
 POLAND
WWW.LUMEL.COM.PL

EXEMPLARY FUNCTIONS OF KD8 ASSISTING SOFTWARES

SOFTWARES ASSISTING THE KD8 RECORDER WORK:

KD CONNECT

Software destined for the communication between the recorder and the PC computer through the USB interface in order to download archive data and record/erase on the CF card.

KD CHECK

Software destined to verify the digital signature in archive data stored in text format.

Recorder information:
Copyright (c) 2007-2008 by LZAE Lumel S.A.
Screen Recorder KD8
System version: 0.5.0.3 (13/05/2008, 12:00)
Hardware version: 00.00.00.00.00.00.00
Image HW ver.: 10.00.00.00.00.00.00
Bootloader version: 0.1.0.0

File name	Date	Size
20080519 121250 0 G1 - Process Group 1.csv	20/05/08 (13:16:50)	3176
20080519 121250 0 G2 - Process Group 2.csv	20/05/08 (13:17:00)	2504
20080519 121250 0 - AuditLog.csv	25/05/08 (13:25:04)	16
20080519 121250 0 G1 - Process Group 1.csv	25/05/08 (09:37:20)	1626
20080525 094720 0 G1 - Process Group 1.csv	25/05/08 (09:24:38)	638
20080525 094720 0 G2 - Process Group 2.csv	25/05/08 (09:24:38)	466
20080525 102500 0 G1 - Process Group 1.csv	25/05/08 (09:25:42)	398
20080525 102440 0 G1 - Process Group 1 - AlarmLog.csv	25/05/08 (09:25:42)	1548
20080525 102500 0 G2 - Process Group 2.csv	25/05/08 (09:25:42)	316
20080525 112600 0 G1 - Process Group 1.csv	25/05/08 (09:42:36)	118

Downloading and erasing of archive data by means of the PC computer - KD CONNECT.

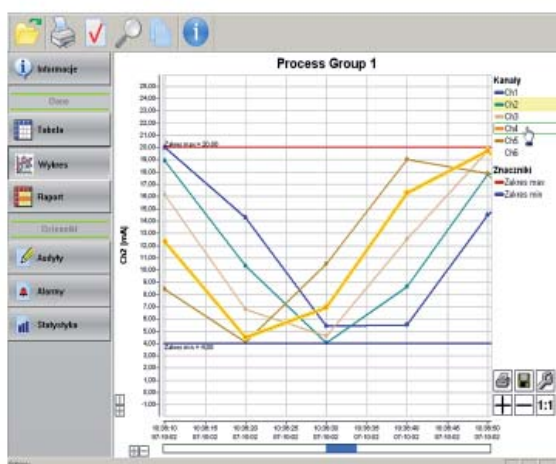

Review of archive data through the PC computer - KD ARCHIVE.

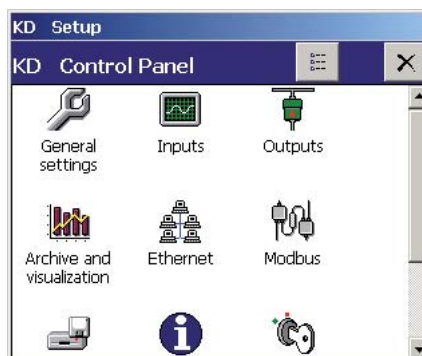

Configuration of the KD8 recorder by means of the PC computer - KD8 SETUP.



Verification of the digital signature of text data - KD CHECK.

Export department:
English: +48 68 32 95 302 / 321 / 276 / 386 / 233
German: +48 68 32 95 305
French: +48 68 32 95 304
Russian: +48 68 32 95 321
Fax: +48 68 32 54 091
e-mail: export@lumel.com.pl
LUMEL S.A.
ul. Sulechowska 1
65-022 Zielona Góra
POLAND
WWW.LUMEL.COM.PL

OVERALL DIMENSIONS

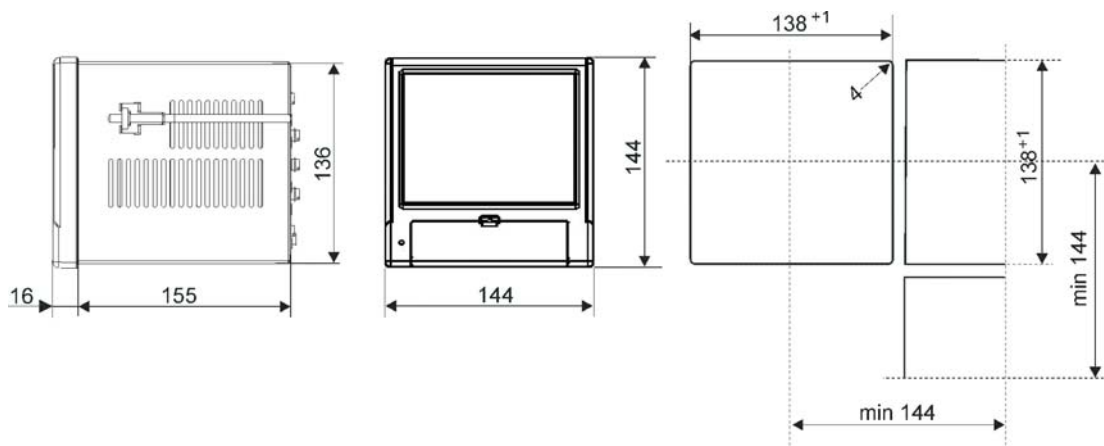

SEE ALSO:



Temperature sensors.



Interface converter PD10.



KD7 recorder.



For more information about LUMEL's products please visit our website:
www.lumel.com.pl

ORDERING

Screen Recorder KD8 -	X	X	X	X	XX	X
Measuring inputs:						
3 programmable measuring inputs	1					
6 programmable measuring inputs	2					
Alarms and binary inputs:						
without alarms and binary inputs	0					
alarms (NO relays) + binary inputs ¹⁾	1					
Supply:						
90..253 V a.c.		1				
Softwares servicing the recorder from PC:						
KD Connect, KD Check				1		
KD Connect, KD Check, KD Archive, KD8 Setup				2		
Version:						
standard					00	
custom made ²⁾					XX	
Acceptance tests:						
without extra quality inspection requirements						8
with an extra quality inspection certificate						7
according to customer's request ²⁾						X

¹⁾ for each 3 measuring inputs a package with 6 alarms and 4 binary inputs is installed

²⁾ after agreeing with the manufacturer

Example of order:

the code **KD8-1-0-1-1-00-8** means:

- KD8** - recorder of KD8 type,
- 1** - with 3 programmable measuring inputs,
- 0** - without alarms and binary inputs,
- 1** - supply: 90 .. 253 V a.c.,
- 1** - with KD Connect and KD Check softwares,
- 00** - in standard version,
- 8** - without extra quality inspection requirements.

Export department:

English: +48 68 32 95 302 / 321 / 276 / 386 / 233
German: +48 68 32 95 305
French: +48 68 32 95 304
Russian: +48 68 32 95 321
Fax: +48 68 32 54 091
e-mail: export@lumel.com.pl

LUMEL S.A.
 ul. Sulechowska 1
 65-022 Zielona Góra
 POLAND

WWW.LUMEL.COM.PL