

DATA LOGGER  
FOR IoT APPLICATIONS  
**SM61IoT**



USER'S MANUAL



---

**Contents:**

<u>1. Application</u> .....	3
<u>2. Data logger set</u> .....	4
<u>3. Basic requirements, safety of use</u> .....	4
<u>4. Assembly</u> .....	5
<u>4.1. Fixing way</u> .....	5
<u>4.2. Electrical connections</u> .....	6
<u>4.3. Data logger configuration</u> .....	9
<u>4.3.1. Configuration using USB interface</u> .....	11
<u>4.3.2. Configuration using RS-485 interface</u> .....	12
<u>4.3.3. Configuration using LAN interface</u> .....	12
<u>5. SM61Config software</u> .....	13
<u>5.1. Installation</u> .....	13
<u>5.2. First start</u> .....	13
<u>5.2.1. Selection of communication way</u> .....	13
<u>5.2.2. First run using USB interface</u> .....	14
<u>5.2.3. First run using LAN interface</u> .....	15
<u>5.3. Software functions</u> .....	16
<u>5.3.1. Main menu</u> .....	17
<u>5.3.2. List of SM61IoT devices</u> .....	17
<u>5.3.3. Ethernet configuration</u> .....	18
<u>5.3.4. Serial port configuration</u> .....	20
<u>6. Web browser</u> .....	21
<u>6.1. The beginning of work with the browser</u> .....	21
<u>6.2. Logging</u> .....	21
<u>6.3. Overall look</u> .....	22
<u>6.4. Website menu</u> .....	24
<u>6.5. Administration</u> .....	25
<u>6.5.1. General settings</u> .....	25
<u>6.5.2. Date and time settings</u> .....	26
<u>6.5.3. Users</u> .....	27
<u>6.5.4. Event log</u> .....	28
<u>6.6. Configuration</u> .....	28
<u>6.6.1. Channels configuration</u> .....	28
<u>6.6.2. Alarms configuration</u> .....	34
<u>6.6.3. Synoptic map configuration</u> .....	37
<u>6.6.4. Serial port configuration</u> .....	41
<u>6.6.5. Ethernet configuration</u> .....	43
<u>6.6.6. Archive upload</u> .....	44
<u>6.7. Data presentation</u> .....	45
<u>6.7.1. Channels values presentation</u> .....	45
<u>6.7.2. Synoptic map presentation</u> .....	47
<u>6.8. Language change</u> .....	48
<u>7. FTP Client</u> .....	49
<u>8. Configuration of MQTT</u> .....	51
<u>8.1 Protocol description</u> .....	51
<u>8.2 Configuration of the MQTT module</u> .....	51
<u>9. Internal archive</u> .....	53
<u>9.1. Archiving configuration</u> .....	53
<u>9.2. Downloading archive data</u> .....	55
<u>9.3. Structure of archive files</u> .....	55
<u>10. Alarms and binary inputs</u> .....	56
<u>11. Interface RS-485</u> .....	57
<u>11.1. Description of functions</u> .....	57
<u>11.2. Error codes</u> .....	60
<u>11.3. Registers map</u> .....	61
<u>12. Technical data</u> .....	75
<u>13. Ordering codes</u> .....	76

# 1. Application

The SM61IoT data logger is meant to communication and archiving data in distributed measuring and control systems. It can service remote analogue and binary inputs/outputs modules, measuring transducers, inverters, microcontrollers, recorders, display panels, HMI panels etc.

There are available two serial ports to the communication. PORT 1 is for communication with PC computer and HMI panels (RS-485, RS-232, USB), PORT 2 is for communication with such Slave devices (RS-485). The SM61IoT data logger reads and archives data from devices equipped with protocol Modbus RTU and serial interfaces (RS-485 or RS-232). Data exchange with main computer is done through computer network (Ethernet) with the use of network protocols (TCP/IP, FTP).

The data logger has an innovative configuration and data presentation interface which is user friendly. It has an ability to monitor and configure through SM61Config software and through web browser.

The data logger features:

- possibility of simultaneous connection of two Modbus TCP clients,
- up to 8 GB FLASH memory,
- readout of up to 2500 values from Slave devices.

The exemplary use of SM61IoT data logger in a local computer network is presented on fig. 1.

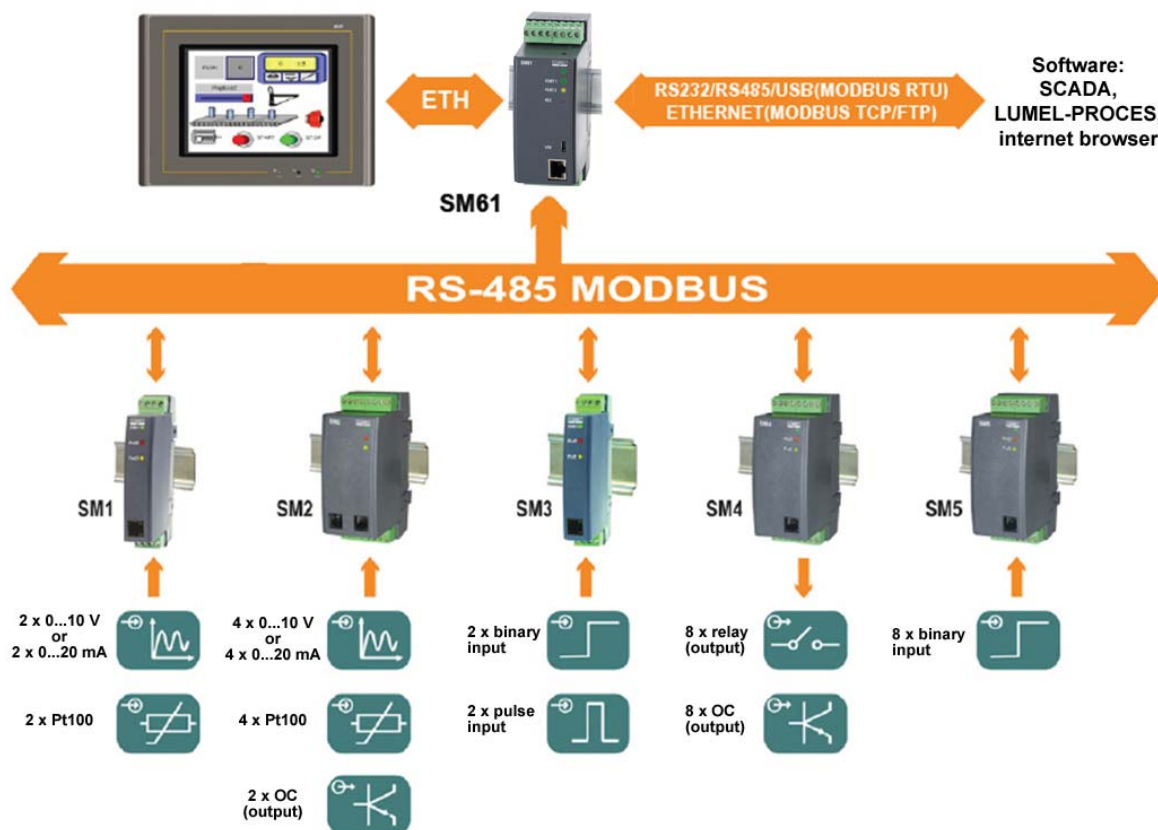

Fig. 1. Exemplary use of SM61IoT

## 2. Data logger set

The set includes:

1. data logger SM61IoT..... 1 pc
2. quick start manual..... 1 pc
3. CD with the software and user's manual.....1 pc

## 3. Basic requirements, safety of use

Symbols placed in the manual means:



- Especially important, you should know before you connect the data logger. Failure to follow the remarks could lead to damage of the data logger.



- Pay special attention if a data logger works inconsistently to your expectations

### Notice:

**The removal of the data logger casing during the guarantee contract period lead to its cancellation.**



### Observations concerning the operational safety:



- All operations concerning transport, installation and commissioning as well as maintenance must be carried out by qualified, skilled personnel, and national regulations for the prevention of accidents must be observed.
- Before switching the data logger on, one must check the correctness of connections of the network.
- Before the remove of the casing one should switch off data logger power and measurement circuits.
- The device is destined to be installed and used in industrial electromagnetic environment conditions.

A switch or a circuit - breaker should be located near the device, easy accessible by the operator and suitable marked.

## 4. Assembly

### 4.1. Fixing way

The SM61IoT data logger is fixing on rail bracket 35 mm. Dimensions and fixing way are shown at fig. 2.

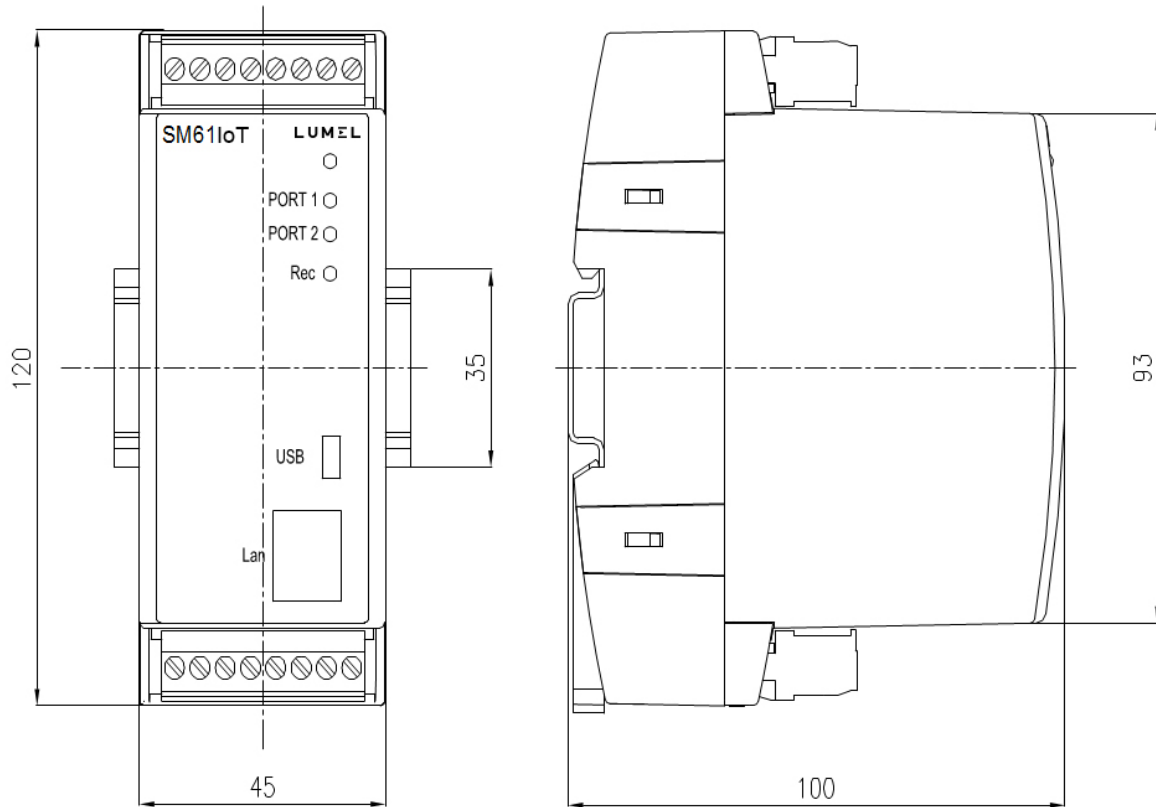

Fig. 2. Dimensions and fixing way

## 4.2. Electrical connections

Power and external inputs should be connect according to the fig. 3 and table 1 in which is described destiny of the particular terminals in SM61IoT data logger.

Terminals description of data logger Table 1

Supply depend on the code version  
 85...253 V a.c., 90...300 V d.c.  
 or 20...40 V a.c., 20...60 V d.c.  
 or 10...16 V a.c., 10...20 v d.c.

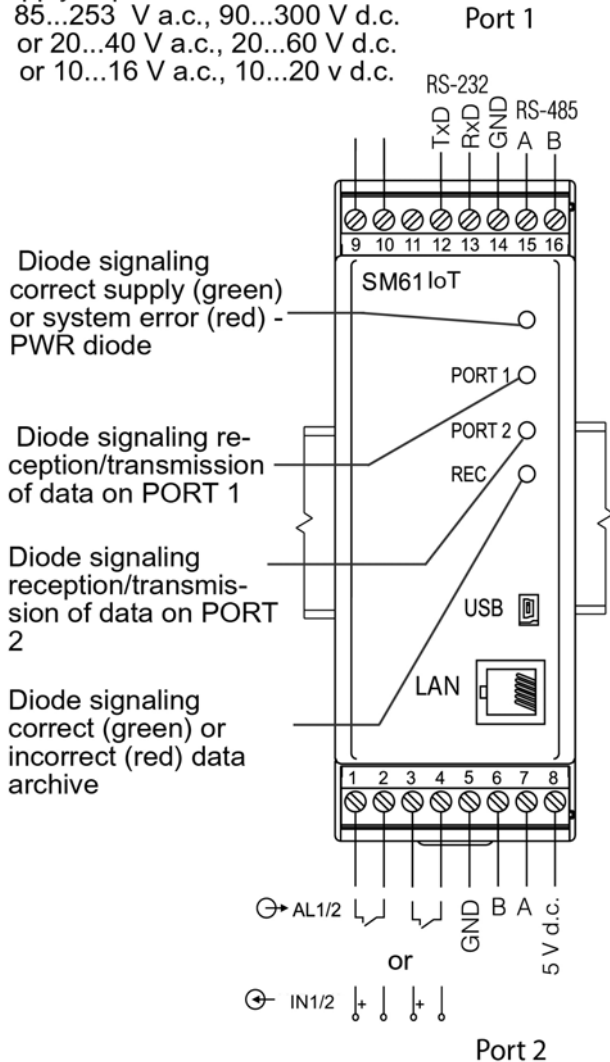

Terminal	Description
1	Input line (+ input 1) or line of alarm 1
2	Input line (- input 1) or line of alarm 1
3	Input line (+ input 2) or line of alarm 2
4	Input line (- input 2) or line of alarm 2
5	GND line
6	Line B (RS-485)
7	Line A (RS-485)
8	Line 5 V d.c.
9	Line + of power
10	Line - of power
11	not used
12	Output TxD (RS-232)
13	Output RxD (RS-232)
14	Line GND
15	Line A (RS-485)
16	Line B (RS-485)

Fig. 3. Electrical connections of SM61IoT

The SM61IoT has four communication interfaces:

1. PORT 1 - serial interface:

- purpose - communication with Master device,
- bus - RS-232, RS-485,
- terminals - 14, 15, 16 (RS-485) and 12, 13, 14 (RS-232),
- galvanically isolated from rest of the system,
- maximum length of bus depends on the speed of transmission (for high speeds of up to several tens of meters, for small, e. g. 9600 bit/s to about 1.2 km).

---

## 2. PORT 2 - serial interface:

- purpose - communication with Slave device,
- bus - RS-485,
- terminals - 5,6,7,8,
- galvanically isolated from rest of the system,
- maximum length of bus depends on the speed of transmission (for high speeds of up to several tens of meters, for small, e. g. 9600 bit/s to about 1.2 km).

## 3. USB - serial interface:

- protocol of data exchange: Modbus RTU,
- purpose - device configuration,
- connection - mini USB.

## 4. LAN :

- protocol of data exchange: Modbus TCP,
- purpose - device configuration,
- allow to connect device to Ethernet network (the way of connection shown on fig. 4),
- connection - RJ-45.

To connect SM61IoT to Ethernet network it is advisable to use a twisted-pair cable:

- U/FTP – a twisted-pair cable with each pair on a separate screen with the film,
- F/FTP – a twisted-pair cable with each pair on a separate screen in addition to film-screen,
- S/FTP ( formerly SFTP) – a twisted-pair cable with any pair foiled in addition to the screen mesh,
- SF/FTP ( formerly S-STP) – a twisted pair cable with each pair twisted foil in addition to film and screen grid.

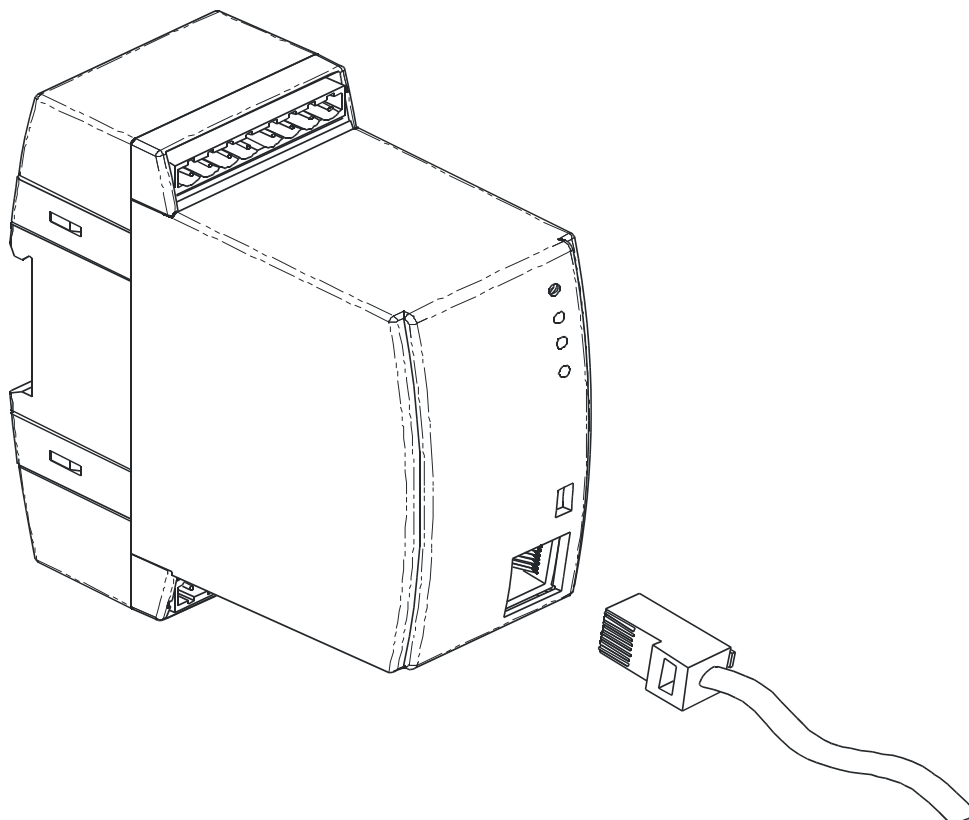

Fig. 4. Connecting Ethernet wire to RJ-45 socket

The category of twisted pair according to European standard EN 50171 minimal: class D (category 5) – for fast local network, includes applications which uses the frequency band up to 100 MHz. Description of the connection is shown at table 2. For the interface Ethernet there should be applied a twisted-pair cable type STP (shielded) category 5 with a plug RJ-45 with cables colours (according to table 2) in the following standard:

- EIA/TIA 568A for both connectors in simple connections SM61IoT to a hub or switch,
- EIA/TIA 568A for first connector and EIA/TIA 568B for second connector in connection with crossover (connection SM61IoT to a computer).

Wire colors in a RJ-45 plug

Table 2

Wire No.	Signal	Wire color in accordance to standard	
		EIA/TIA 568A	EIA/TIA 568B
1	TX+	white - green	white - orange
2	TX-	green	orange
3	RX+	white - orange	white - green
4	EPWR+	blue	blue
5	EPWR+	white - blue	white - blue
6	RX-	orange	green
7	EPWR-	white - brown	white - brown
8	EPWR-	brown	brown



After connection device to Ethernet network it is able to configure settings using HTTP protocol or Modbus TCP.

The data logger set include CD with USB driver and software SM61Config, which is used to find devices in Ethernet network and configure them by Modbus RTU (USB) or Modbus TCP (Ethernet) protocol.



**Notice:**

To get full resistance of data logger on electromagnetic interference one should follow these rules:

- do not supply the data logger from the network which is near pulse noise generators (inverters) and do not use common with them grounding circuits;
- use network filters;
- all shields should be grounded or connected to the protective unit, one sided the nearest to the data logger;
- **use the general rule, the wires leading different signals should be carried out in the greatest distance from each other (no less then 30 cm), the intersection of these beams is performed at 90°.**

### 4.3. Data logger configuration



**Notice:**

**First run of a device requires configuration of basic parameters.**

Delivered device has default settings presented in table 3:

*Default settings* *Table 3*

<b>PORT 1</b>	
<b>RS-485</b>	
Address	1
Mode	RTU 8N1
Baud rate	9600 bit/s
<b>PORT 2</b>	
<b>RS-232</b>	
Mode	RTU 8N1
Baud rate	9600 bit/s
<b>RS-485</b>	
Mode	RTU 8N1
Baud rate	9600 bit/s

<b>USB</b>	
Address	1
Mode	RTU 8N1
Baud rate	115200 bit/s
<b>LAN</b>	
<b>LAN interface</b>	
IP Address	192.168.1.1
Mask	255.255.255.0
Gateway	0.0.0.0
LAN speed	Auto
<b>Modbus TCP</b>	
Address	255
Port	502
<b>Ports TCP/IP</b>	
HTTP	80
FTP command port	21
FTP data port	22
Search	2323

Running of SM61IoT comes in two stages. In the first stage the procedures of testing and configuration reading in the activated SM61IoT, are initiated. First, the device makes a test of external memory. If the test result is not carried out correctly, the device will restart. After correct testing, the configuration data are read out. The configuration data readout error is signaled by switching on of a red diode PWR (fig. 3) and a proper setting of an error status value (table 21). The error of configuration readout imposes the setting of default data presented in the table 3. After configuring basic communication parameters, Modbus RTU for USB interface and RS-485/232 for Slave mode is activated.

Then the device launches the next stage - the readout of channels configuration for Master RS-485. The configuration readout lasts for about 20 seconds and is signaled by switching on of REC diode (fig. 3) in green color. The occurrence of a configuration readout error disconnects the data readout and is signaled by switching on of a red diode PWR (fig. 3) and a proper setting of an error status value (table 21). The readout of the whole configuration imposes launching of remaining modules, such as:

- LAN module,
- Modbus RTU module for Master mode,
- archive module,
- alarms module,
- statistical data operation module.

After reading the configuration, the device is ready for further work. At first run, the data logger is using default settings. However, right after the first activation the data logger configuration ought to be carried out in order to prepare it for work at a defined environment. Configuration may be carried out using:

- USB (VIRTUAL PORT COM, Modbus RTU),
- PORT1 (RS-485, Modbus RTU),
- LAN (Modbus TCP, HTTP).

#### 4.3.1. Configuration using USB interface

In order to configure the device through USB interface, the device ought to be connected with the mini USB cable to PC. After connecting a data logger, the operational system will notify of the occurrence of a new device by displaying a message presented in fig. 5. Found New Wizard of Universal Serial Bus will activate automatically. Wizard's suggestions ought to be followed by selecting installation from the indicated localization and giving a tract for drivers, which can be found on an attached CD. Drivers are compatible with the following systems: Windows 2000, XP, Server 2003, Vista, Windows 7, Server 2008 (x86 and x64). At drivers installation, a message signaling lack of drivers digital signature can occur. Ignored them and proceed with further installation.

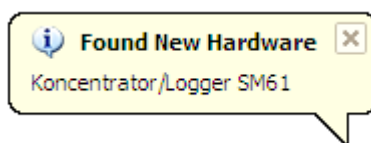

Fig. 5. Message signaling detection of new device **Data logger/Logger SM61IoT**

After closing the wizard, the system will immediately detect another device - USB Serial Port (fig. 6). Found new hardware wizard will be restarted. During the installation process, all wizard suggestions ought to be followed.

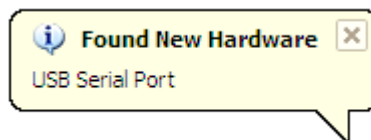

Fig. 6. System message on finding new device

After successful installation, the system will notify on installing a new device (fig. 7). Two new devices will appear in Device Manager - **Data logger/Logger SM61IoT** and Port COM named: **data logger/Logger SM61IoT**, according to fig. 8.



Fig. 7. System message finishing drivers installation of SM61IoT

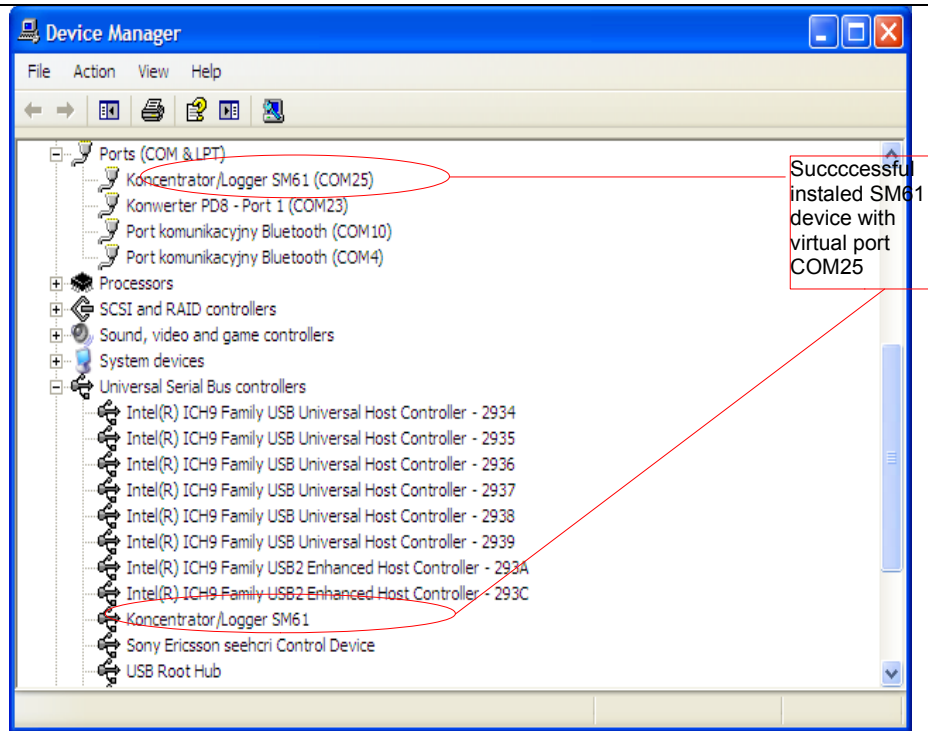

Fig. 8. Device manager window with installed SM61IoT with assigned port No. COM25

Then SM61Config software on attached CD ought to be run and installation procedures with user guide for first application run ought to be followed, point [5. SM61Config software](#).

After entering configuration it ought to be saved and the device restarted so that a new configuration can be entered.



**Notice:**  
After changing the parameters the device should be reset.

#### 4.3.2. Configuration using RS-485 interface

In order to configure the device by interface RS-485, the device ought to be connected using a converter (e.g. PD 10) to a PC. Then in accordance with tables 19 and 20 from point [10.3. Registers map](#), which contains registers map of SM61IoT, using own program or a device compatible with Modbus RTU do the data logger configuration.

#### 4.3.3. Configuration using LAN interface

In order to configure the device by LAN interface, the device ought to be connected to the Ethernet network. Then SM61Config software on attached CD ought to be run and installation procedures from user guide for first application run ought to be followed, point [5. SM61Config software](#).



**Notice:**  
After changing the parameters the device should be reset.

In case of problems it is advised to restore default parameters and restart configuration, in accordance with points 4.3.1-3. Restoring default parameters can be done:

- during device operation time by pressing the button located in the upper part of the casing,
- by selecting “Default Settings” in the program “SM61Config” (see point [5. SM61Config software](#)).

## 5. SM61Config software

The SM61Config software allows for searching all data loggers in Ethernet network and to configure a selected SM61IoT device using protocol Modbus RTU (interface USB) or using protocol Modbus TCP (LAN interface). The SM61Config also allows for downloading archive files from data logger using FTP protocol.

To apply any changes in configuration of the data logger it is required to enter the password for the administrator account. Default administrator password is:

dbps [6.5.3. Users](#)

For more information about users, see point .

### 5.1. Installation

Installation program is found on CD attached to SM61IoT. To run an installation on a computer, the software SM61Config\_install\_v\_X\_X\_X.exe should be started. This is an application that installs SM61Config with essential accessories on a user's computer. During installation one ought to proceed in accordance with the instructions displayed on the screen.

### 5.2. First start

At first start of SM61IoT it is required to configure basic IP settings, such as:

- IP address,
- subnet mask,
- default gateway address.

Needed information should be given from local network administrator in which device will be joined.

The SM61Config software enables the user to configure network setting of SM61IoT by USB interface or by Modbus TCP (LAN interface, Ethernet).

#### 5.2.1. Selection of communication way

After installing the application one ought to run it. The default communication with device is Modbus TCP. After starting application the searching devices window appears. Then select the way of communication with the device, from the software menu (*Option -> Communication*), fig. 9.

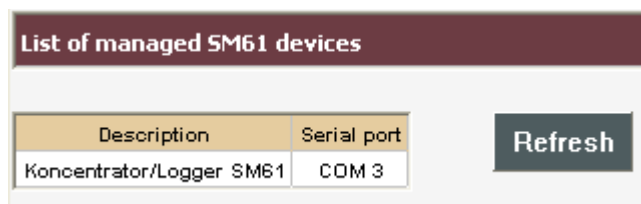

Fig. 9. Selection of communication way from the device

Then proceed to the further configuration.

### 5.2.2. First run using USB interface

After selecting communication way, proceed to list of devices (show devices connected via USB – fig. 10).



Description	Serial port
Koncentrator/Logger SM61	COM 3

Refresh

Fig. 10. List of devices connected via USB

After selecting device by left-click on proper line of list one can go to configuration by selecting a proper option from the menu (presented in fig. 11).

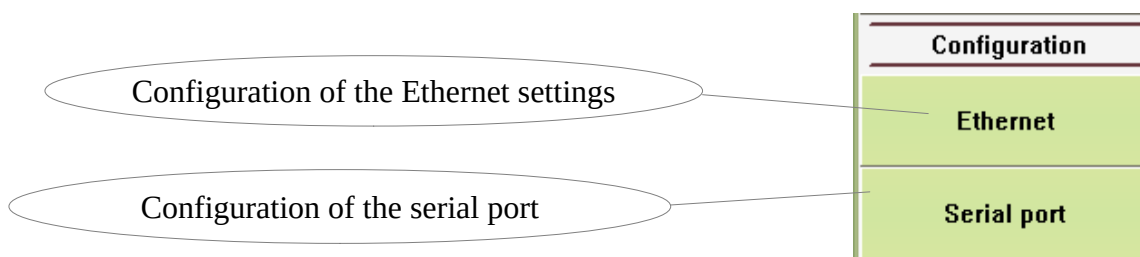

Fig. 11. Left menu options

Configuration of individual settings is described in points [5.3.3. Ethernet configuration](#) and [5.3.4. Serial port configuration](#) in further part of the user's manual.

After right-click on the appropriate line of the list the context menu appears (shown in fig.12).

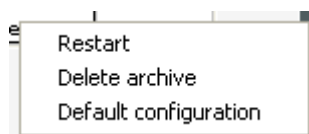

Fig. 12. Context menu searching via USB



**Notice:**

**After changing the parameters the device should be reset.**

### 5.2.3. First run using LAN interface

After selecting the communication way with the device, open the SM61Config and display the list of searched devices connected to Ethernet network by selecting the option *List of SM61IoT device* from the menu shown in fig. 13.

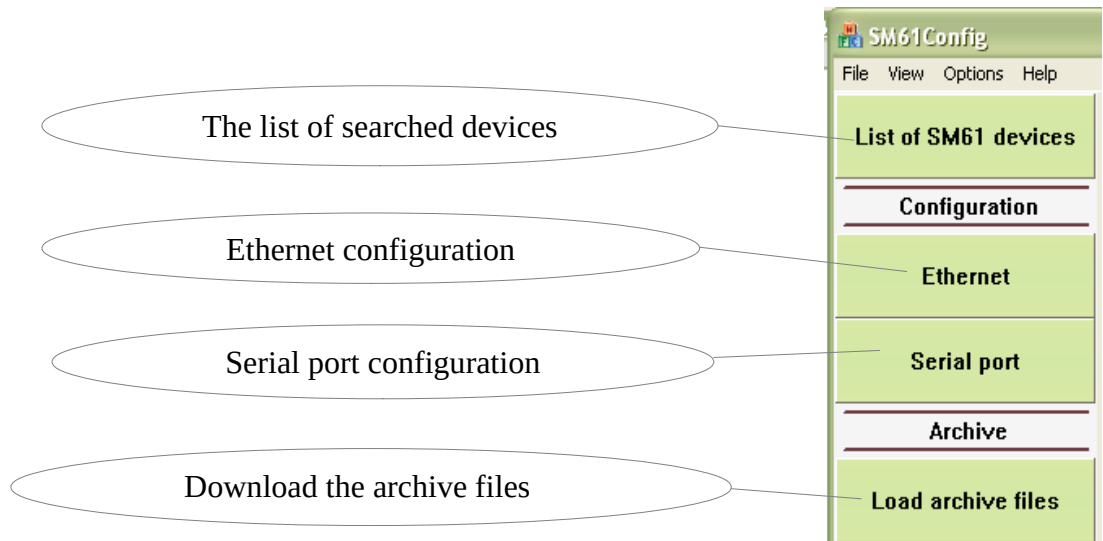

Fig. 13. Left menu options of SM61Config

After left click on a selected device from the list of searched data loggers, new context menu presented on the fig. 14 Will appear.

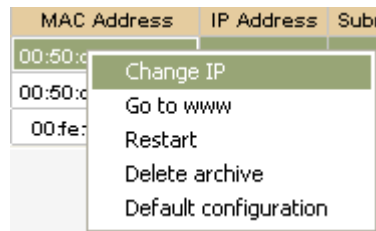

Fig. 14. Context menu allowing for IP settings change

Selecting *Change IP* causes the appearance of window that enables for configuration of the following settings (fig. 15):

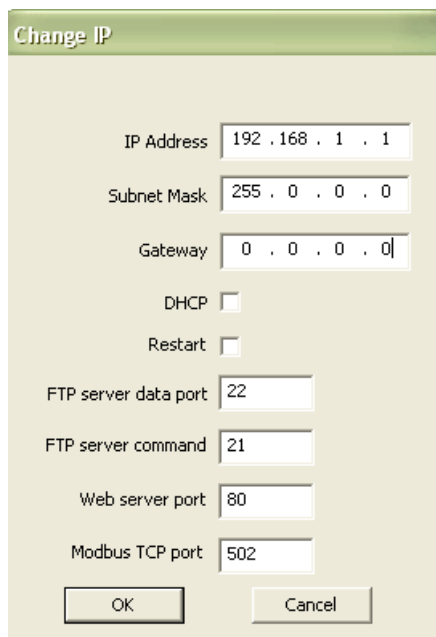

Fig. 15. Change of IP settings

After entering changes, clicking *OK* will cause the window to shut down and will save the changes in the device memory.



**Notice:**  
After changing the parameters the device should be reset.

### 5.3. Software functions

After opening of the software the window presented on the fig. 16. It is possible to open only one application window.

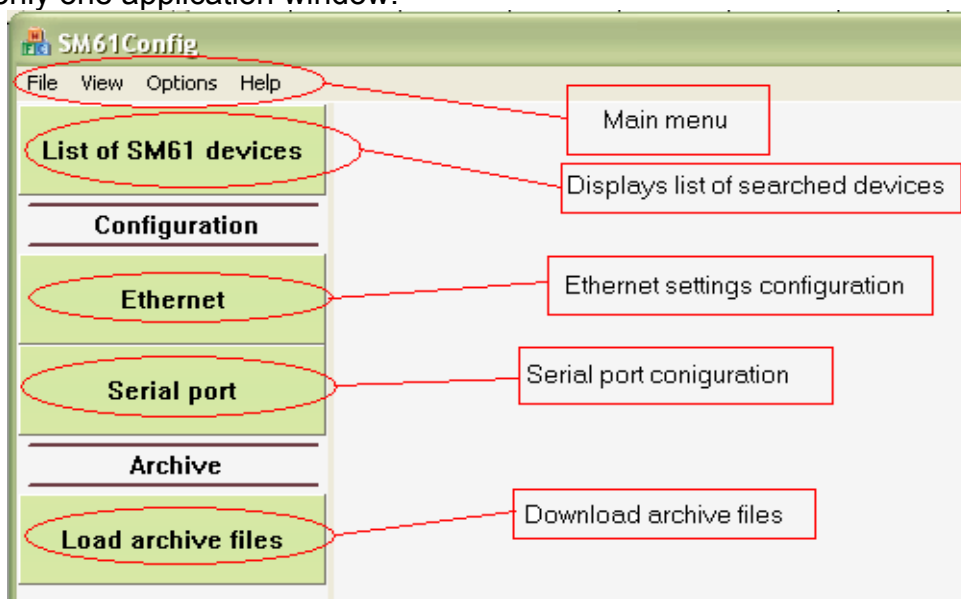

Fig. 16. General appearance of SM61Config



### 5.3.1. Main menu

Main menu presented on the fig. 17 enables:

1. File
  - Exit - close software.
2. View
  - Status bar - show or hide status bar.
3. Options
  - Languages - language change.
  - Communication - allows for the change of communication way with the device. There are two ways of communication: USB (USB interface) and Modbus (LAN interface). Selecting an USB option requires connecting the device to the USB port and does not require selecting the device from the list. Selecting Modbus TCP option requires, for the sake of further work, selecting the device from the list. Communication via Modbus TCP is set as default.
4. Help
  - About - information about software version.

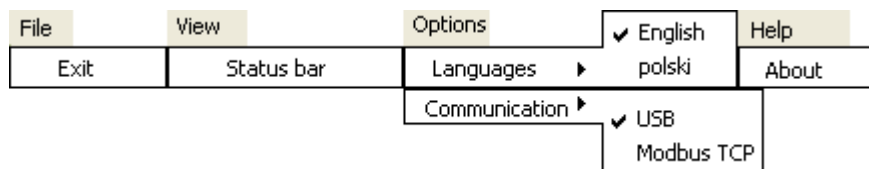

Fig. 17. Structure of the main menu

### 5.3.2. List of SM61IoT devices

Selecting an option *List of SM61IoT devices* allows for searching existing devices in Ethernet network or devices connected via USB (fig. 18).

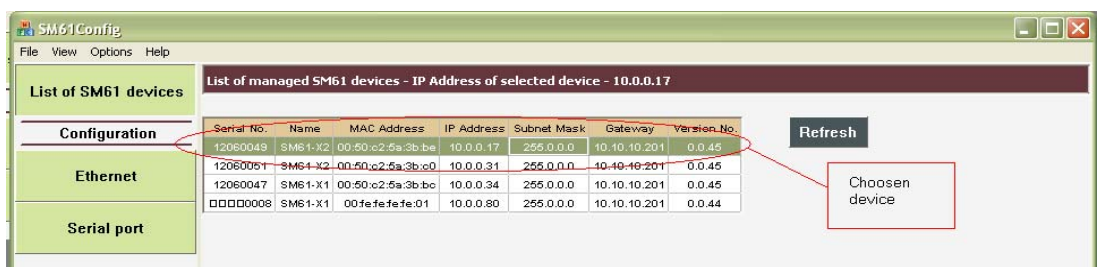

Fig. 18. Searched data loggers

Selecting a device for configuration is done by left click on an IP address of a chosen device. Then the whole line will highlight in a way presented on the fig. 18. After selecting a device, move forward to its configuration by selecting a right option (Ethernet or Serial Port).

Right click on an IP address of a selected device causes displaying of context menu presented on the fig. 19.



Fig. 19. Menu invoked with a right click (left menu – communication via Modbus TCP, right menu – communication via USB)

Functions of menu presented on the fig. 19 allow:

- Change IP - allows for configuration of a device in a way presented on the fig. 15 in the point [5.2.3. First run using LAN interface](#).
- Go to www - selecting this option causes moving to a site of a selected device in Internet browser.
- Restart - causes a restart of device.
- Delete archive - causes deleting the whole archive from the device memory (more about archive in the point [8. Internal archive](#)).
- Default configuration - causes restoring default data, requires to restart the device.

All activities described above are carried out using Ethernet network connection.

### 5.3.3. Ethernet configuration

One of the two possible ways of communication (USB or Modbus TCP) can be used for configuration. The selection of the communication way proceeds as follows: select *Options* from the main menu then *Communication* and from submenu way of communication as fig. 9 in the point [5.2.1. Selection of communication way](#) presented.

In case of selecting communication by Modbus TCP, it is first necessary to select a device with which a connection is to be made from the list. Configuration window is presented on the fig. 20.

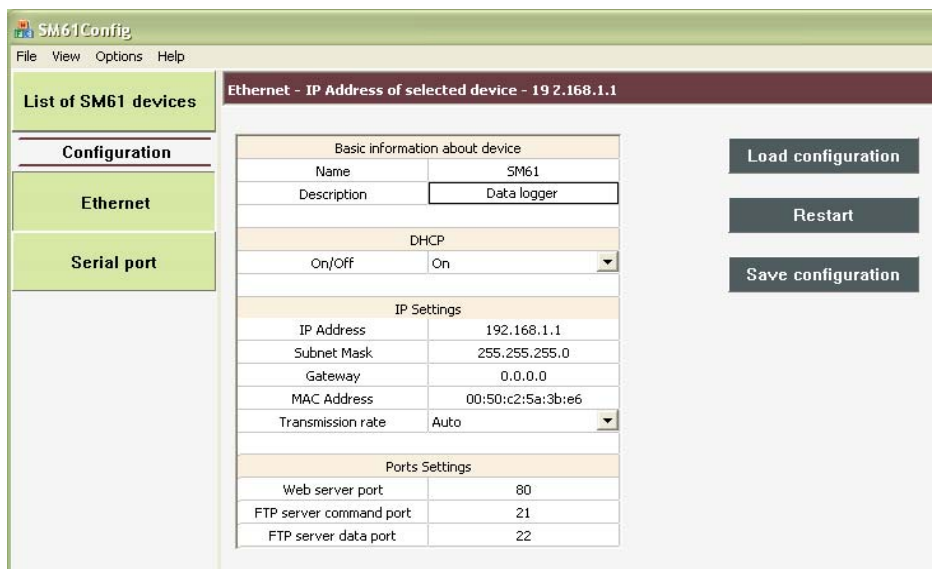

Fig. 20. Window of Ethernet configuration

Parameters presented on the fig. 20 are described in the table 4.

Parameters describe

Table 4

Name	Description
Name	device name, maximum 8 characters
Description	device description, maximum 20 characters
DHCP	on or off DHCP
IP Address	IP Address, address i fourth version Ipv4
Subnet mask	subnet mask
Gateway	device gateway
MAC Address	address MAC, MAC is given in such a format XX:XX:XX:XX:XX:XX
Baud rate	baud rate: - auto (defalut) - 10Mbit - 100Mbit
Web server port	number of web server port, values from 80 (defalut) to 65535
FTP server data port	number of FTP server data port, possible values from 20 to 65535 (default value 22)
FTP server command port	number FTP server command port, possible values from 20 to 65535 (default value 21)

After entering changes, select *Save configuration*. After saving the configuration the information on successful or unsuccessful entry will be displayed. In the case of communication with a device using USB, the saving procedure may take more time than in the case of communication using Modbus TCP (Ethernet network).



**Notice:**  
After changing the parameters the device should be reset.

There is a possibility of re-loading of configuration by *Load configuration*. In the case of selecting communication using USB, there is an additional possibility to set default MAC Address (fig. 21).

Adres MAC	00:50:00:5a:00:c0	<b>Set default MAC Address</b>
-----------	-------------------	--------------------------------

Fig. 21. Setting of default MAC Address

### 5.3.4. Serial port configuration

For serial port configuration, like in the case of Ethernet configuration, one of the two possible ways of communication (USB and Modbus TCP) can be used. The selection of the way of communication is presented on the fig. 9 in the point [5.2.1. Selection of communication way](#). Configuration window is presented on the fig. 22.

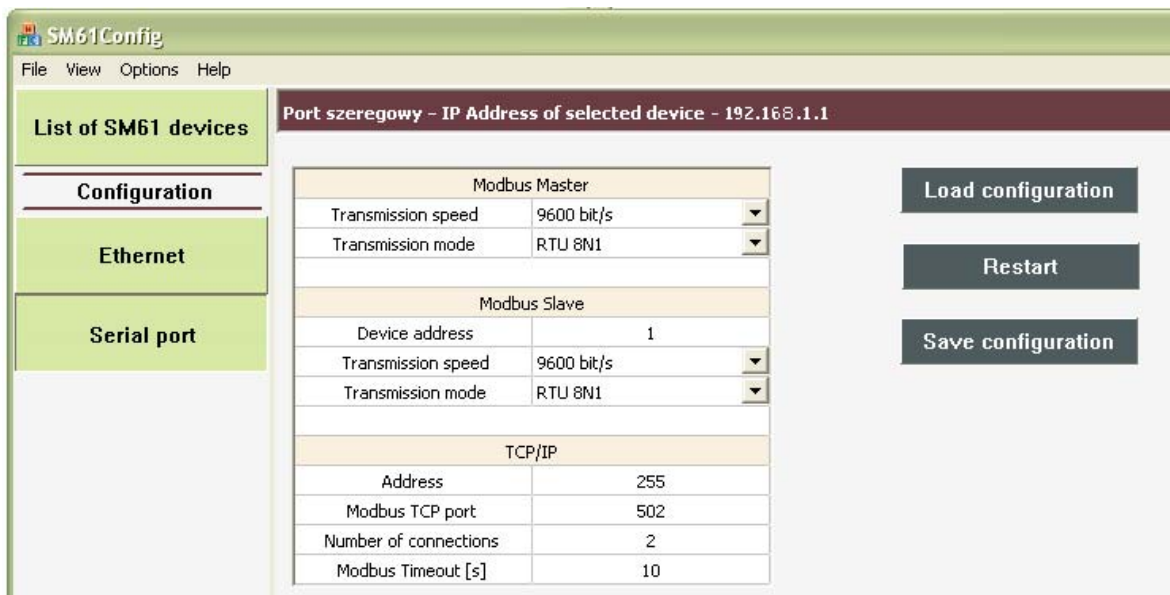

Fig. 22: Serial port configuration

Parameters presented on the fig. 22 are described in the table 5.

Parameter description

Table 5

Name	Description
<b>Modbus Master</b>	
Bud rate	Modbus Master transmission speed can assume the following values: 1200bit/s, 2400bit/s, 4800bit/s, 960bit/s, 19200bit/s, 38400bit/s, 57600bit/s, 115200bit/s
Transmission mode	Modbus Master transmission mode, two following values are possible: 8N2, 8E1, 8O1, 8N1
<b>Modbus Slave</b>	
Device Address	Device address can assume values from 1 up to 255
Baud rate	The same like for Modbus Master
Transmission mode	The same like for Modbus Master
<b>Modbus Slave TCP</b>	
Address	The same like for Modbus Slave
TCP Modbus port number	TCP Modbus Port Number can assume values from 10 up to 100 (default port number)
Number of simultaneous connections with TCP Modbus	Maximum number of simultaneous connections (possible setting from 1 to 4 simultaneous connections)
TCP port closing time	TCP port closing time, possible values from 10s up to 600s

After entering changes, select *Save configuration*. After saving the configuration the information on successful or unsuccessful entry will be displayed. In the case of communication with a device using USB, the saving procedure may take more time than in the case of communication using Modbus TCP (Ethernet network).

**Notice:**

**After changing the parameters the device should be reset.**

There is a possibility of re-loading of configuration via *Load configuration*. In the case of selecting communication using USB, configuration window looks exactly the same like for communication via Modbus TCP.

## 6. Web browser

The data logger makes its own WWW server available to monitor and configure measurable values and a device condition. SM61IoT site enables to:

- obtain information on a device (serial No., name, etc.),
- view of current measurable values,
- configure data logger settings.

**Notice:**

**For proper working of web site one need to have the browser with JavaScript enabled and compatible with XHTML 1.0**

**(all popular browsers, Internet Explorer version minimum 8).**

### 6.1. The beginning of work with the browser

At its first run, the SM61IoT requires the setting of protocol IP essential information, such as:

- own IP address,
- network mask,
- default gateway address.

Needed information should be given from local network administrator in which device will be joined. SM61IoT first run ought to be carried out in accordance with point [4.3. Data logger configuration](#).

To obtain access to server it is required to connect SM61IoT to Ethernet working in accordance with the TCP/IP protocol.

The access to server is gained through entering data recorder IP address in the web browser, e.g.: <http://192.168.1.1> (where 192.168.1.1 is data logger default address). One can also use web browser call in SM61Config software, which is presented on the fig. 17 in the point [5.3.2. List of SM61IoT devices](#).

### 6.2. Logging

To start work with a browser it is necessary to be logged at the site. User's login and password need to be entered. SM61IoT has a default user:

- **login:** root
- **password:** dbps

For safety reasons, after the first run of browser the logging and the password ought to be changed into different than default ones, (see point [6.5.3. Users](#)).

### 6.3. Overall look

After logging in the main site presented on the fig. 23.

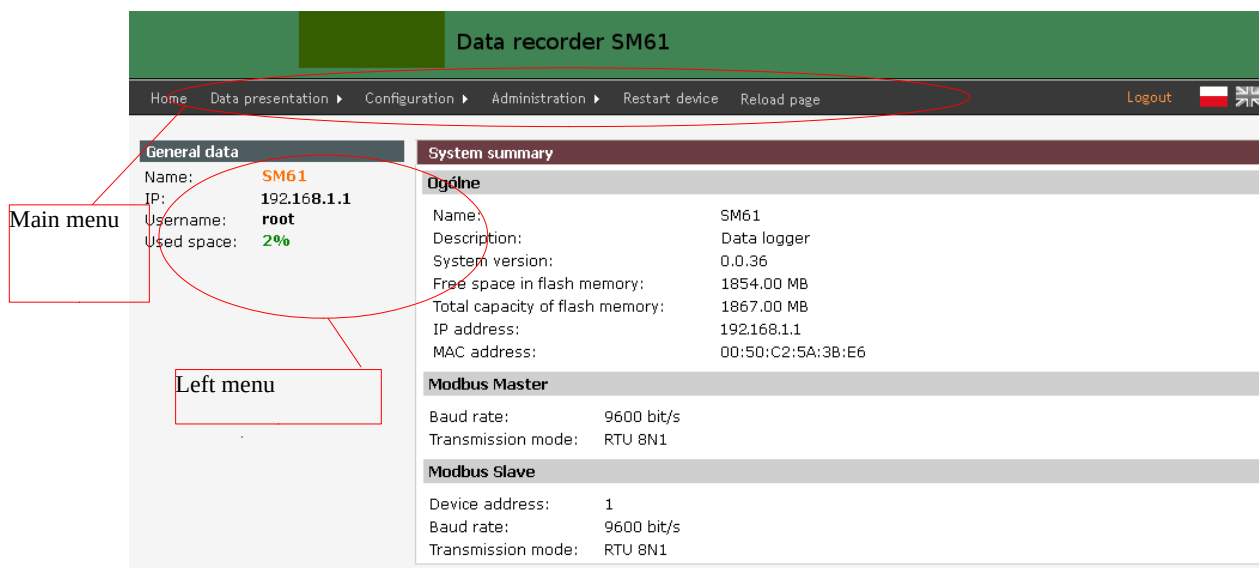

Fig. 23. Homepage

There are the following elements of the site:

- a) The top menu of the site (fig. 24):



Fig. 24. Top menu

Detailed description of menu in the point [6.4. Site menu](#).

- b) Logout and language change option (fig. 25):



Fig. 25. Change of language and user's logout

Language change option is described in the point [6.8. Language change](#). *Logout* option logs out the user.

c) Left menu (fig. 26):

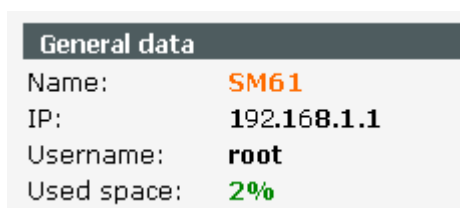

General data	
Name:	SM61
IP:	192.168.1.1
Username:	root
Used space:	2%

Fig. 26. Left menu

The content of the left menu depend on the option selected from the top menu. For all possible options the fixed element that appears in the left menu is general information about device, such as:

- name,
- IP Address,
- name of the logged user,
- the amount of an occupied area in data logger memory in percentage.

d) Main part of the site (fig. 27):

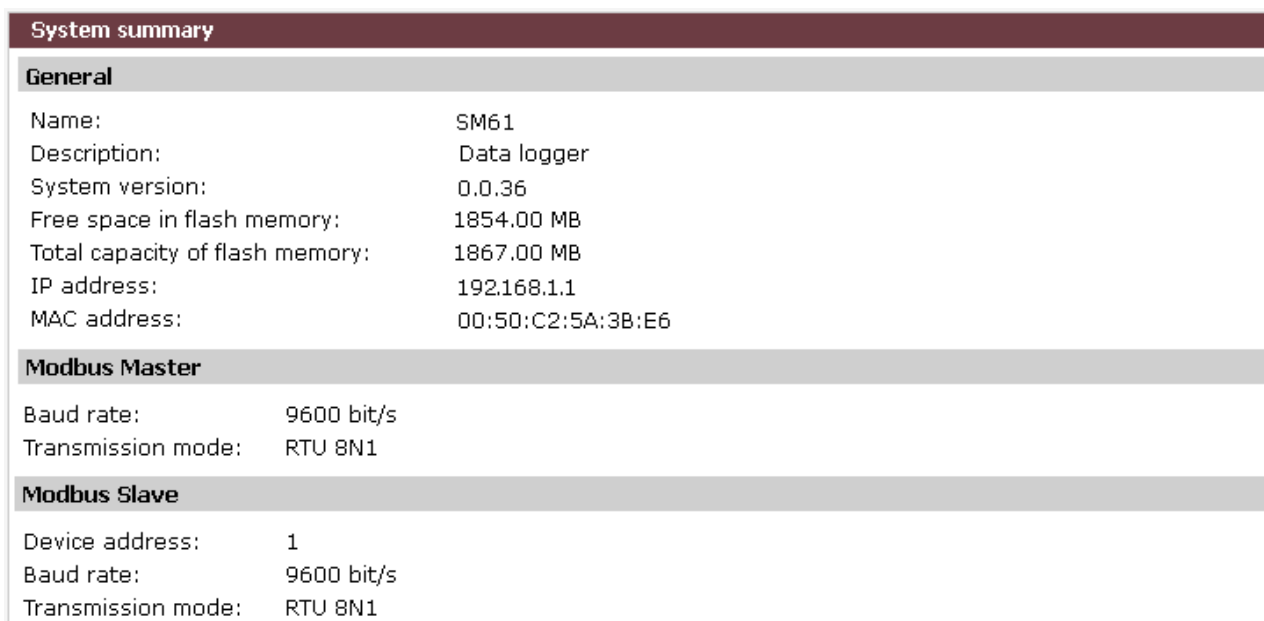

System summary	
<b>General</b>	
Name:	SM61
Description:	Data logger
System version:	0.0.36
Free space in flash memory:	1854.00 MB
Total capacity of flash memory:	1867.00 MB
IP address:	192.168.1.1
MAC address:	00:50:C2:5A:3B:E6
<b>Modbus Master</b>	
Baud rate:	9600 bit/s
Transmission mode:	RTU 8N1
<b>Modbus Slave</b>	
Device address:	1
Baud rate:	9600 bit/s
Transmission mode:	RTU 8N1

Fig. 27. Main part of the site

This element of the site changes according to the option selected from the top menu.

## 6.4. Website menu

The structure of the top menu of the site is presented on the fig. 28:

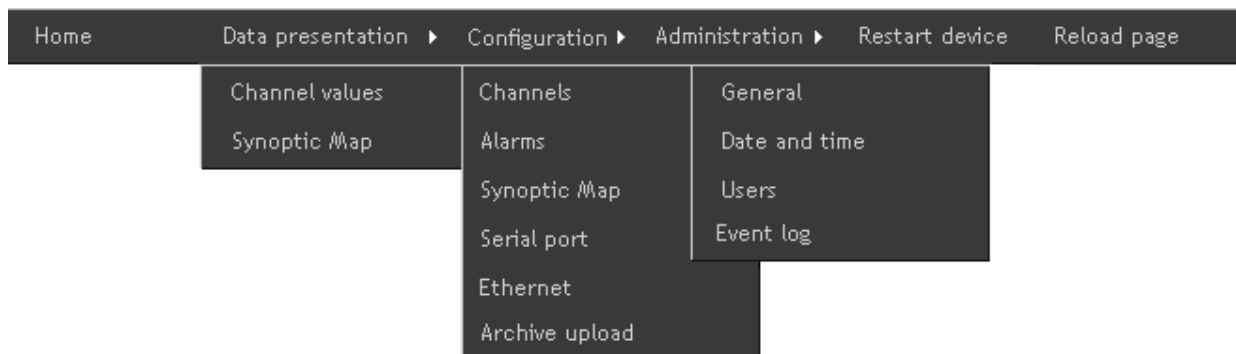

Fig. 28. The structure of the top menu of the site

The site menu consists of the following elements:

- a) Home - contains general information on module.
- b) Data presentation – contains the following elements:
  - Channels values - contain the presentation of values loaded from the device, presented as a table and as a chart (point [6.7.1. Presentation of channels values](#)),
  - Synoptic map - contains the presentation of the current synoptic map (point [6.7.2. Presentation of synoptic map](#)).
- c) Configuration- consists of the following elements:
  - Channels - allows for configuration of all channels and their values (point [6.6.1. Channel configuration](#)).
  - Alarms - allow for alarms configuration (point [6.6.2. Alarms configuration](#)),
  - Synoptic map- allows for synoptic map configuration (point [6.6.3. Synoptic map configuration](#)),
  - Serial port - allows for serial port configuration (point [6.6.4. Serial port configuration](#)),
  - Ethernet - allows for Ethernet settings configuration (point [6.6.5. Ethernet configuration](#)).
  - Archive upload - archive files from the device are automatically sent to the remote FTP server (point [6.6.6. Archive upload](#))
- d) Administration - contains the following options:
  - General - allows for the change of name and device description, the change of records number in an archive file, archive mode and setting of starting page (point [6.5.1. General settings](#)),
  - Date and time - allows for the change of date and time in a device (point [6.5.2. Date and time setting](#)),
  - Users- allows for the change of login and password (point [6.5.3. Users](#)).
  - Event log - displays information from the device about his work (point [6.5.4. Event log](#)).
- e) Restart device - allows for device restart, after the restart configuration is reloaded.
- f) Reload page – allows reload page.



## 6.5. Administration

The SM61IoT data logger allows for time synchronization by web browser. Option *Administration* allows for both time synchronization and users' accounts management.

Going to *Administration* is presented on the fig. 29.

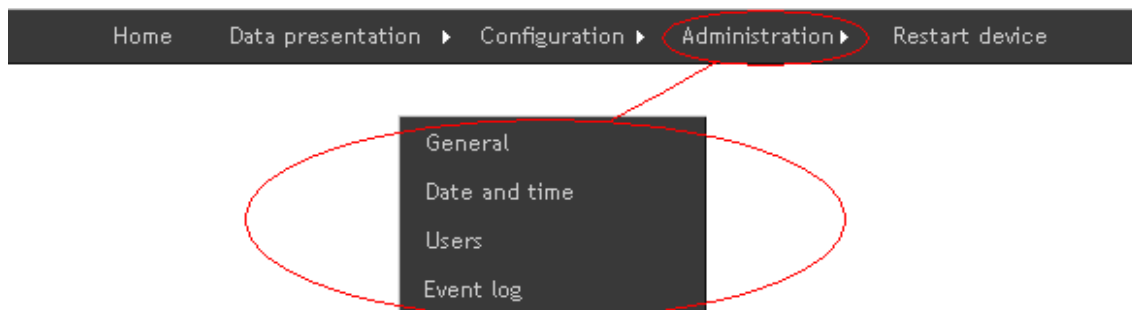

Fig. 29. Top menu - administration

### 6.5.1. General settings

To go to general settings select option *Administration* from the main menu and then from the submenu which is displayed select *General* in a way presented on the fig. 29. General settings possible for configuration are presented on the fig. 30 and in table 6.

**Administration**

**General**

Device name:	<input type="text" value="SM61"/>
Device description:	<input type="text" value="Koncentrator"/>
Active channels:	<input type="text" value="20"/> <a href="#">?</a>
Number of records in an archive file:	<input type="text" value="20"/> <a href="#">?</a> <a href="#">Calculate file filling time</a>
Archive mode:	<input type="text" value="Archiving enabled"/> <input type="checkbox"/>
Session expiration time:	<input type="text" value="5 h"/> <input type="checkbox"/>
Starting page:	<input type="text" value="Home page"/> <input type="checkbox"/>

Fig. 30. General settings

*General settings description*

*Table 6*

Name	Description
Device name	may contain maximum 8 characters
Device description	may contain maximum 20 characters
Active channels	how many channels from available 100 to use, affect performance

Number of records in archive file	from 20 up to 32000
Archive mode	following cases are possible: - archiving able - archiving disable - archiving invoked by A1 (for device with alarms – alarm 1) or by B1 (for device with inputs) - archiving invoked by A2 (for device with alarms – alarm 2) or by B2 (for device with inputs)
Session expiration time	this is the time after which the user will be logged out from the site, a choice of values: -1 minute -5 minutes -30 minutes -1 hour - 5 hours
Starting page	there are three possibilities: - homepage - values - synoptic map

### 6.5.2. Date and time settings

To set time and date choose option *Administration* from menu and then from submenu choose option *Date and time*, according to fig. 32 in the point [6.5. Administration](#). Data logger allows for the change of date and time, the window enabling for date and time configuration is presented on the fig. 31.

Fig. 31. Date and time settings

### 6.5.3. Users

To go to users settings choose option *Administration* from the menu and then choose option *Users* from the submenu according to fig. 32 in the point [6.5. Administration](#). Selecting the option *Users* displays the list of all users, presented on the fig. 32.

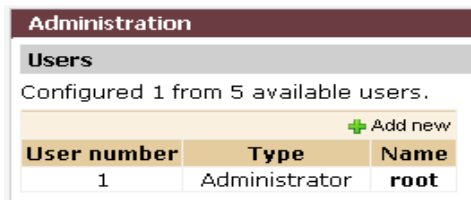

Administration		
Users		
Configured 1 from 5 available users.		
+ Add new		
User number	Type	Name
1	Administrator	root

Fig. 32. List of users

There are two types of users accounts:

- administrator's account,
- normal account .

Administrator has an access to a device configuration and to users accounts configuration. The normal account does not allow for changes in users accounts and does not have the option *Administration* in the menu. Administrator's account is the only one. The other accounts are of normal type.

Option *Add new* (fig. 35) allows for adding a new user, giving a new user its name and password and defining an account type. Right click on one of the users name from the list displays a context menu presented on the fig. 33.

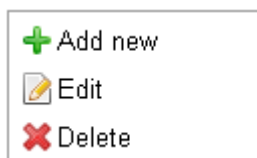
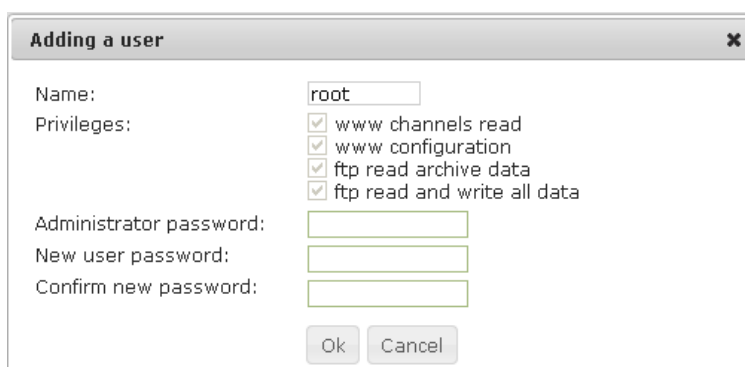

Fig. 33. Users options menu

Option *Edit* allows for editing user's settings and entering changes. The window editing a user is presented on the fig. 34.



**Adding a user** ✕

Name:

Privileges:  www channels read  
 www configuration  
 ftp read archive data  
 ftp read and write all data

Administrator password:

New user password:

Confirm new password:

Fig. 34. User's data edition

### 6.5.4. Event log

Event log tab displays information about the unit, as shown in fig. 35, it is information how to create files, save the configuration, turn on the device. The list of events can be refreshed or deleted by selecting the appropriate button positioned above the list of events.

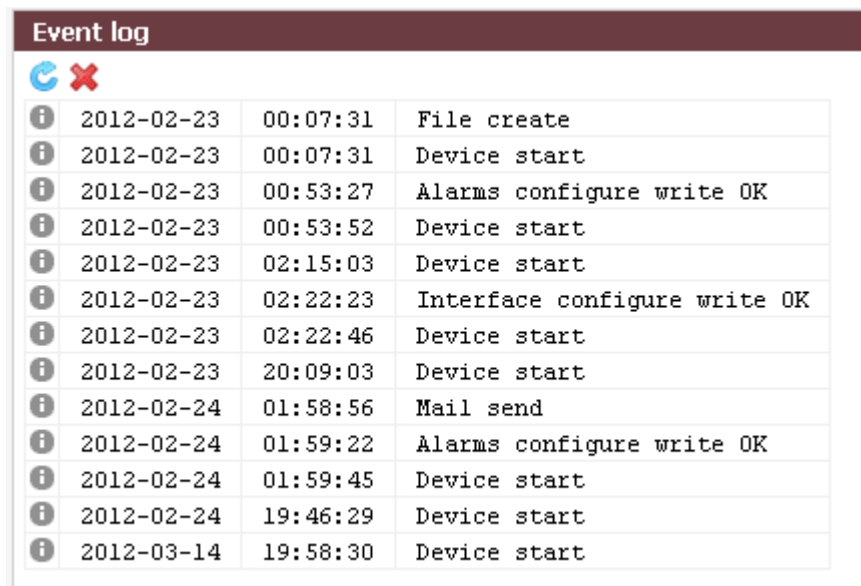















Event log		
		
	2012-02-23 00:07:31	File create
	2012-02-23 00:07:31	Device start
	2012-02-23 00:53:27	Alarms configure write OK
	2012-02-23 00:53:52	Device start
	2012-02-23 02:15:03	Device start
	2012-02-23 02:22:23	Interface configure write OK
	2012-02-23 02:22:46	Device start
	2012-02-23 20:09:03	Device start
	2012-02-24 01:58:56	Mail send
	2012-02-24 01:59:22	Alarms configure write OK
	2012-02-24 01:59:45	Device start
	2012-02-24 19:46:29	Device start
	2012-03-14 19:58:30	Device start

Fig. 35: Event log from device

## 6.6. Configuration



### Notice:

**Data logger requires configuration. It is absolutely necessary to reset the device after parameters change.**

### 6.6.1. Channels configuration

The SM61IoT data logger has maximum 100 virtual channels, one channel has maximum 25 values. Values include measurable data delivered by registers.

To go to channel configuration choose option *Configuration* from the menu and then option *Channels* from the submenu that will be displayed, as it is presented on the fig. 36.

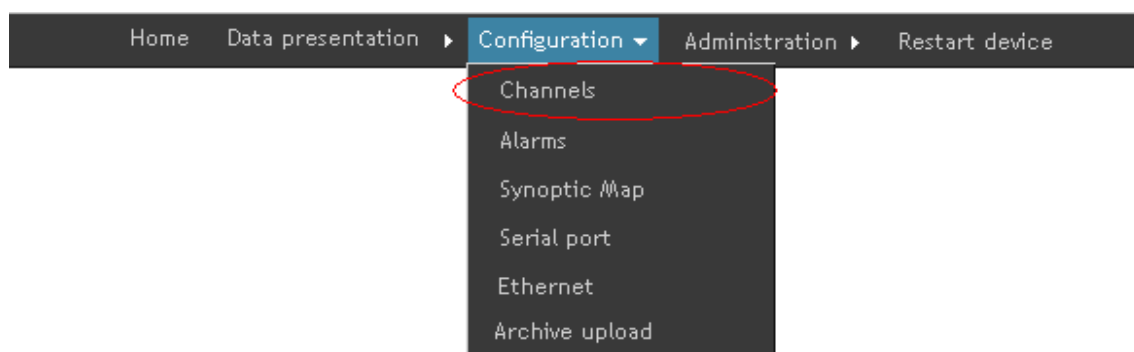

Fig. 36. Channels configuration

Then the site presented on the fig. 37 displays:

General data		Channels - configuration										
Name:	SM61	All channels										
IP:	192.168.1.1	Page 1 from 4 On page 25										
Username:	root											
Used space:	2%											
Channels configuration		Channel number	Name of the first value	Channel mode	Device address	Base register address	Register size	Registers type	Polling interval	Archiving interval	Device timeout	Number of values
Channel selection		1	val_1	Full	1	8000	16b	float4321	1	10	500	10
<input checked="" type="radio"/> All		2		Off	-	-	-	-	-	-	-	0
<input type="radio"/> Active		3		Off	-	-	-	-	-	-	-	0
<input type="radio"/> Monitored		4		Off	-	-	-	-	-	-	-	0
<input type="radio"/> Archived		5		Off	-	-	-	-	-	-	-	0
<input type="radio"/> Turned off		6		Off	-	-	-	-	-	-	-	0
		7		Off	-	-	-	-	-	-	-	0
		8		Off	-	-	-	-	-	-	-	0
		9		Off	-	-	-	-	-	-	-	0
		10		Off	-	-	-	-	-	-	-	0
		11		Off	-	-	-	-	-	-	-	0
		12		Off	-	-	-	-	-	-	-	0
		13		Off	-	-	-	-	-	-	-	0
		14		Off	-	-	-	-	-	-	-	0
		15		Off	-	-	-	-	-	-	-	0
		16		Off	-	-	-	-	-	-	-	0
		17		Off	-	-	-	-	-	-	-	0
		18		Off	-	-	-	-	-	-	-	0
		19		Off	-	-	-	-	-	-	-	0
		20		Off	-	-	-	-	-	-	-	0
		21		Off	-	-	-	-	-	-	-	0
		22		Off	-	-	-	-	-	-	-	0
		23		Off	-	-	-	-	-	-	-	0
		24		Off	-	-	-	-	-	-	-	0
		25		Off	-	-	-	-	-	-	-	0

Fig. 37. Site view with channels configuration

The left menu contains data logger general data and the option of channel selection which are to be displayed in the main part of the site. The following options are available :

- a) All - all channels are displayed,
- b) Active - he option displays channels with the channel mode set on:
  - monitored,
  - archived,
  - full,
- c) Monitored
  - monitored,
  - full,
- d) Archived
  - archived,
  - full,
- e) Turned off - the option displays channels with the channel mode set on- turned off.

Displaying all channels is a default setting (regardless the work mode that is set on), they are displayed at the number of 25 on one site (fig. 39). The number of channels displayed on a site can be changed in a way presented on the fig. 38.

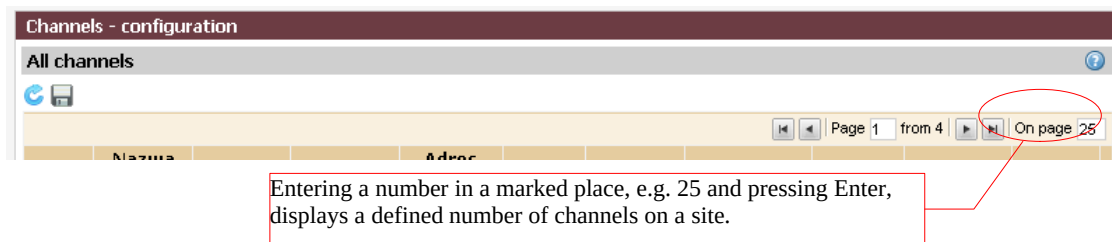

Fig. 38. Setting the number of channels displayed on a site

Graphic signs using in channels configuration are presented in the table 7.

<i>Graphic signs</i>	<i>Table 7</i>
<b>Sign</b>	<b>Meaning</b>
	Help
	re-loading of channels configuration from the device
	saving current configuration of all channels (setting memorized after the device restart), at channels edition saving the configuration of a single channel (not memorized after the device restart)
	at channel edition – returns to channels view

The table presenting channels contains only selected information on a channel e.g.:

- channel number,
- name of the first channel value,
- channel mode,
- device address,
- base register address,
- register size,
- registers type,
- polling interval,
- archiving interval,
- device timeout,
- number of values,
- an icon informing whether the channel is active (🟢) or not active (🔴),

To go to a selected channel right click on a number of a selected channel and choose *Edit* from the context menu presented on a the fig. 39. Option *Copy* allows for copying the configuration from the other channel.

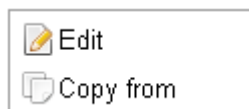

Fig. 39. Context menu

After selecting the option *Edit* the view containing all information about selected channel and its values is displayed. The view containing information about a channel is presented in the fig. 40.

 A screenshot of a configuration window titled 'Channels - configuration' with a subtitle 'Editing channel number 1'. It contains several settings:
 

- Channel mode: Monitored (dropdown)
- Source type: Modbus RS (dropdown)
- Device address: 2 (text input)
- Base register address: 7000 (text input)
- Register size: 16b (dropdown)
- Registers type: float (dropdown)
- Polling interval: 2 s (text input)
- Archiving interval: 0 s (text input)
- Device timeout: 4 ms (text input)

Fig. 40. Channel configuration

Parameters displayed on the fig. 40 are described in the table 8.

Channels settings

Table 8

Name	Description
Channel mode	the mode of a selected channel: - turned off, - monitored, - archived, - full (monitored and archived), setting archived and full mode will make all values of a given channel archive in a file- details on archiving (see point 8. <a href="#">Internal archive</a> )
Source type	data source for a channel: - Modbus RS (Modbus Slave device), data is loaded from Modbus Slave device, - internal (constant or values from other channel), internal data of a device constitute the data source
Device address	values from 1 up to 255
Base register address	register address that contains data loaded from a device connected to a data logger

Register size	the size of polling registers in bites (16 or 32 bites), all registers are 16-bite size except: - long, - ulong, - float, which can be set ether as 16 or 32-bite size
Registers type	sets the register type in a channel: - char – 16 bites - character data type (two characters ASCII), - uchar - unsigned char- 16 bites - character data type (two characters ASCII), - short - 16 bites (values ranging from - 32768 to 32767), - ushort- unsigned char - 16 bites (values ranging from 0 to 65535), - long - 32 bites or 2x16 bites (values ranging from - 2147483648 to 214748647), - ulong - unsigned long - 32 bites or 2x16 bites (values ranging from 0 to 4294967295), - float1234 - 32 bites or 2x16 bites, a floating - point number, the least significant bite on the first position, - float4321 - 32 bites or 2x16 bites, a floating point number, the least significant bite on the last position
Pooling interval	value from 1 to 65535
Archiving interval	value is active when the mode is archived or full, may assume values from 10 up to 65535
Device timeout	values from 1 up to 65535

The table with channel values displays while editing a channel, fig. 41.

+ Add next   X Delete last									
Value number	Name	Register address	Unit	Individual characteristic number	Mathematical operations		Operations with other channels		
					Mathematical operator	Argument	Mathematical operator	Channel number	Value number
1	val_1	8000							
2	val_2	8002							
3	val_3	8004							
4	val_4	8006							
5	val_5	8008							
6	val_6	8010							
7	val_7	8012							
8	val_8	8014							
9	val_9	8016							
10	val_10	8018							

Fig. 41. Editing channels value

Right click on a number of a selected value displays a context menu presented on the fig. 42.

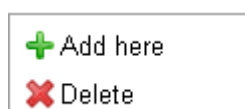

Fig. 42. Context menu



Selecting the option *Add here* adds a new value in the place of a highlighted value (the highlighted one goes to the next position), the option *Delete* deletes the highlighted value. Values properties which can be configured are presented in the table 9.

Values settings

Table 9

Name	Description
Value number	values from 1 up to 25
Value name	the name consists of maximum 15 characters
Register address	automatically calculated based on base register
Unit	presents available units
<b>Mathematical operations</b>	
Mathematical operator	+, -, /, *, =
Argument of mathematical operations	values from 1 up to 214748,36
<b>Mathematical operations with other channels</b>	
Mathematical operator	+, -, /, *, =
Channel number	channel number is used for mathematical operations with other channels
Value number	value number of previously selected channel used for mathematical operations with other channels

It is possible to carry out mathematical operations on configured channel values. Mathematical operations with a quoted argument or selected value from a selected channel can be carried out on the values.

After configuring a single channel, all settings ought to be saved. Saving the channel will cause saving the configuration of a single channel only to a volatile memory which will not be recalled after the device restart. For the configuration to be remembered after the computer restart, go from channel edition to the view of all channels (button - green arrow in left) and save the configuration.

Setting mathematical operations for the value will cause carrying out a mathematical operation on a value being downloading from a device.



**Notice:**

**After changing the parameters the device should be reset.**

### 6.6.2. Alarms configuration

Alarms configuration is available to implementation with alarms, for implementation with binary inputs there is no this site element.

Moving to alarms configuration is presented on the fig. 43.

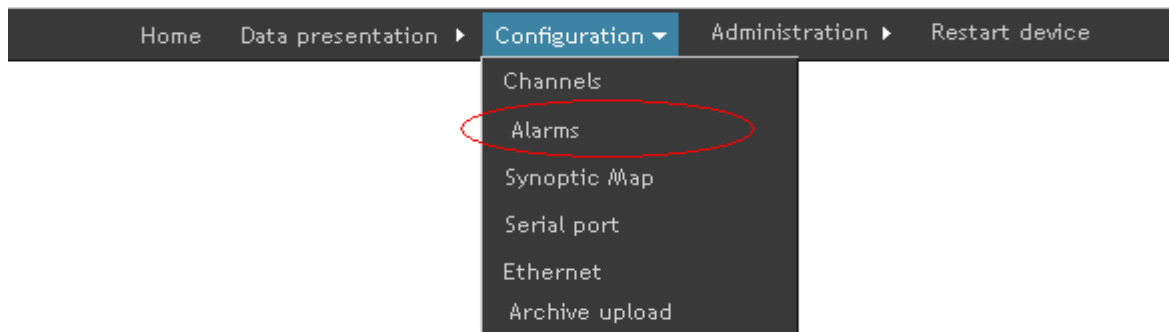

Fig. 43. The way of going to alarms configuration

After the site downloads, the window presented on the fig. 44 will display.

The data logger SM61IoT allows for setting of twenty five alarms. Each of them have the same set of parameters to be configured. Alarms parameters are presented in the table 10.

For each alarm it is possibly to send email with information about its occurrence.

To send a message, one must specify proxy credentials to the SMTP server. It is recommended that the server was located in the same network with the device.



**Notice:**

**Intermediary SMTP server must support AUTH PLAIN authentication after unencrypted connection (usually port 25).**

Alarms - configuration

Email address:

Group messages:

SMTP authentication:

Server name:

Port:

User name:

Password:

[Send test mail](#)

Alarm No.	Trigger source	Channel number	Value number	Alarm type	Lower alarm threshold [ $\leq$ ]	Upper alarm threshold [ $\geq$ ]	ON delay	OFF delay	Set relay	Send mail
1	None	1	2	n-off	-1	2700	0 s	0 s	<input type="checkbox"/> 1 <input type="checkbox"/> 2	<input type="checkbox"/>
2	None	1	1	n-off	210	250	0 s	0 s	<input type="checkbox"/> 1 <input type="checkbox"/> 2	<input type="checkbox"/>
3	None	0	0	n-on	0	0	0 s	0 s	<input type="checkbox"/> 1 <input type="checkbox"/> 2	<input type="checkbox"/>
4	None	0	0	n-on	0	0	0 s	0 s	<input type="checkbox"/> 1 <input type="checkbox"/> 2	<input type="checkbox"/>
5	None	0	0	n-on	0	0	0 s	0 s	<input type="checkbox"/> 1 <input type="checkbox"/> 2	<input type="checkbox"/>
6	None	0	0	n-on	0	0	0 s	0 s	<input type="checkbox"/> 1 <input type="checkbox"/> 2	<input type="checkbox"/>
7	None	1	2	n-off	-100	550	0 s	0 s	<input type="checkbox"/> 1 <input type="checkbox"/> 2	<input type="checkbox"/>
8	None	1	2	n-off	-30	30	0 s	0 s	<input type="checkbox"/> 1 <input type="checkbox"/> 2	<input type="checkbox"/>
9	None	1	2	n-off	12	14.4	0 s	0 s	<input type="checkbox"/> 1 <input type="checkbox"/> 2	<input type="checkbox"/>
10	None	1	1	n-off	12	14.4	0 s	0 s	<input type="checkbox"/> 1 <input type="checkbox"/> 2	<input type="checkbox"/>
11	None	0	0	n-on	0	0	0 s	0 s	<input type="checkbox"/> 1 <input type="checkbox"/> 2	<input type="checkbox"/>
12	None	0	0	off	0	0	0 s	0 s	<input type="checkbox"/> 1 <input type="checkbox"/> 2	<input type="checkbox"/>
13	None	0	0	off	0	0	0 s	0 s	<input type="checkbox"/> 1 <input type="checkbox"/> 2	<input type="checkbox"/>
14	None	0	0	n-on	0	0	0 s	0 s	<input type="checkbox"/> 1 <input type="checkbox"/> 2	<input type="checkbox"/>
15	None	0	0	n-on	0	0	0 s	0 s	<input type="checkbox"/> 1 <input type="checkbox"/> 2	<input type="checkbox"/>
16	None	0	0	n-on	0	0	0 s	0 s	<input type="checkbox"/> 1 <input type="checkbox"/> 2	<input type="checkbox"/>
17	None	0	0	n-on	0	0	0 s	0 s	<input type="checkbox"/> 1 <input type="checkbox"/> 2	<input type="checkbox"/>
18	None	0	0	n-on	0	0	0 s	0 s	<input type="checkbox"/> 1 <input type="checkbox"/> 2	<input type="checkbox"/>
19	None	0	0	n-on	0	0	0 s	0 s	<input type="checkbox"/> 1 <input type="checkbox"/> 2	<input type="checkbox"/>
20	None	0	0	n-on	0	0	0 s	0 s	<input type="checkbox"/> 1 <input type="checkbox"/> 2	<input type="checkbox"/>
21	None	0	0	n-on	0	0	0 s	0 s	<input type="checkbox"/> 1 <input type="checkbox"/> 2	<input type="checkbox"/>
22	None	0	0	n-on	0	0	0 s	0 s	<input type="checkbox"/> 1 <input type="checkbox"/> 2	<input type="checkbox"/>
23	None	0	0	n-on	0	0	0 s	0 s	<input type="checkbox"/> 1 <input type="checkbox"/> 2	<input type="checkbox"/>
24	None	9	2	n-on	-40.09	52.1	0 s	0 s	<input type="checkbox"/> 1 <input type="checkbox"/> 2	<input type="checkbox"/>
25	None	9	2	n-on	40.09	52.1	0 s	0 s	<input type="checkbox"/> 1 <input type="checkbox"/> 2	<input type="checkbox"/>

Fig. 44. Alarms configuration

When configured to send e-mails to several alarms it is recommended to check the option *Group Messages*. In this manner, in the case of the simultaneous occurrence of multiple alarms, it will be sent only one message, thereby excessive load on the server will be avoided.

Each sending a message is recorded in the event registry. Also in case of problems with the delivery of messages, relevant information about the error are saved.

Alarms parameters

Table 10

Name	Description
Trigger source	alarm trigger sources; - none (lack of the alarm) - channel value - configuration error - archiving error - lack of space in FLASH memory - memory filled in 80% - always turned on

Channel number	channel number applicable to an alarm, active when channel value is the trigger source
Value number	channel value number that applies to an alarm, active when channel value is the trigger source
Alarm type	<ul style="list-style-type: none"> <li>- n-on (alarm sets when the value rises above the upper level and turns off when it drops below the lower level)</li> <li>- n-off (alarm turns off when the value rises above the upper level and turns on when it drops below the lower level)</li> <li>- on (when value within the range alarm on, when outside the range alarm off)</li> <li>- off (when value in the range alarm off, when outside the range alarm on)</li> </ul>
Lower alarm threshold	lower alarm threshold, max. 32500000 can be set
Upper alarm threshold	upper alarm threshold, max. 32500000 can be set
ON delay	max. value is 1000s
OFF delay	max. value is 1000s
Set relay	allows you to set the relays for alarm, a choice of two relays
Send mail	allows you to send an email to the above table e-mail address.

After entering changes they ought to be saved. When an alarm is on, a bell symbol with the applicable alarm number is displayed on a site (fig. 45), left click on it cause information about the alarm (fig. 46), that contains the following data:

- number of alarm which is displayed,
- alarm trigger source.



Fig. 45. Information about the alarm



Fig. 46. Information about the alarm

More information on alarms in the point [9. Alarms and binary inputs.](#)

### 6.6.3. Synoptic map configuration

Moving to synoptic map configuration is in accordance with fig. 47.

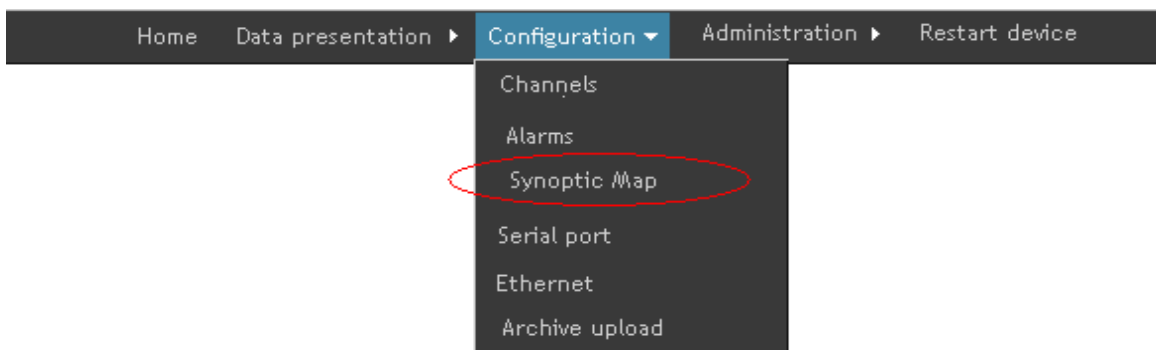

Fig. 47. The way of moving to synoptic map configuration

After the site downloads, the window presented on the fig. 48 displays:

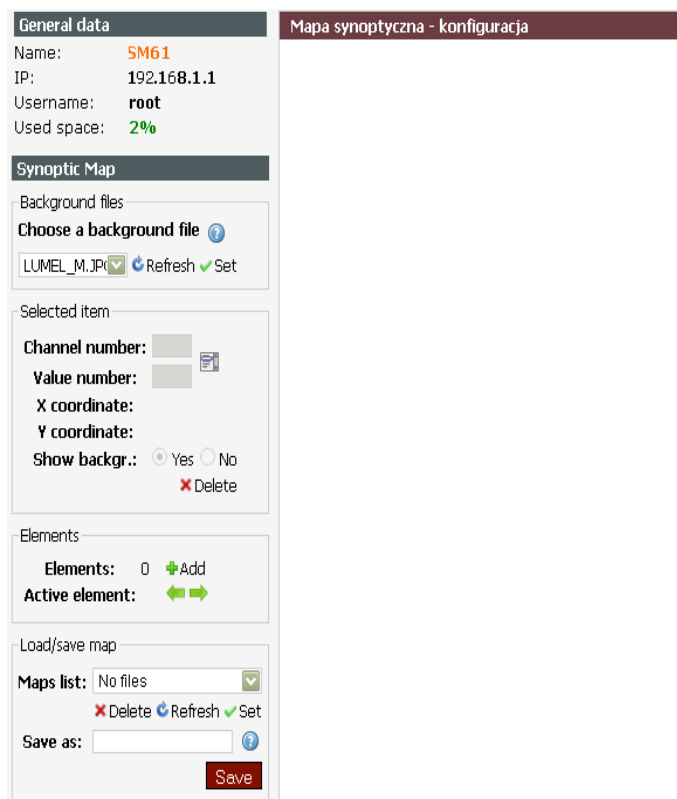

Fig. 48. Edition of synoptic map configuration

On the left side of the window there is the menu allowing for creating and configuring of a synoptic map. The menu divides into the following parts:

- Background files - the element presented on the fig. 49 allows for setting a background file of a map.

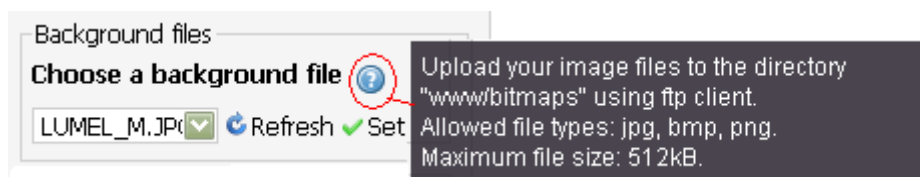

Fig. 49. Selection of files background

Positioning the mouse cursor on a question mark displays information on how to load your own background files (fig. 49). In order to load your own background file, send your image files using FTP client to “WWW/bitmaps” catalog. Servicing FTP client is presented in point [7. FTP Client.](#)

After selecting a file, chose *Set* which displays the selected background on the site. Elements described in b) can be applied on the set background file.

- b) Elements – the part of the left menu presented on the fig. 50, allows for applying new elements on the map.

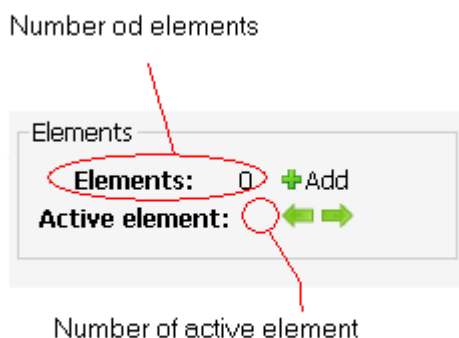

Fig. 50. Elements of synoptic map

To add an element, select *Add*. The added element displays on the map in a way presented on the fig. 51:

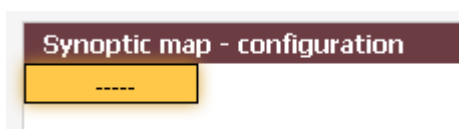

Fig. 51. Element on a synoptic map

The element can be randomly moved on the map. Maximum 15 elements can be placed on the map. An active element is highlighted. By using navigation arrows you can choose which element is to be active.

- c) Selected item- the part of the left menu presented on the fig. 52 contains the information on an active (selected) item:

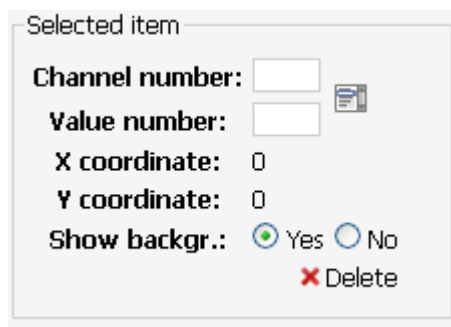

Fig. 52. The left menu of synoptic map- selected item

Channel number and value number of a channel which is to be represented ought to be selected for an item. Numbers can be filled manually or by using a help as presented on the fig. 53:

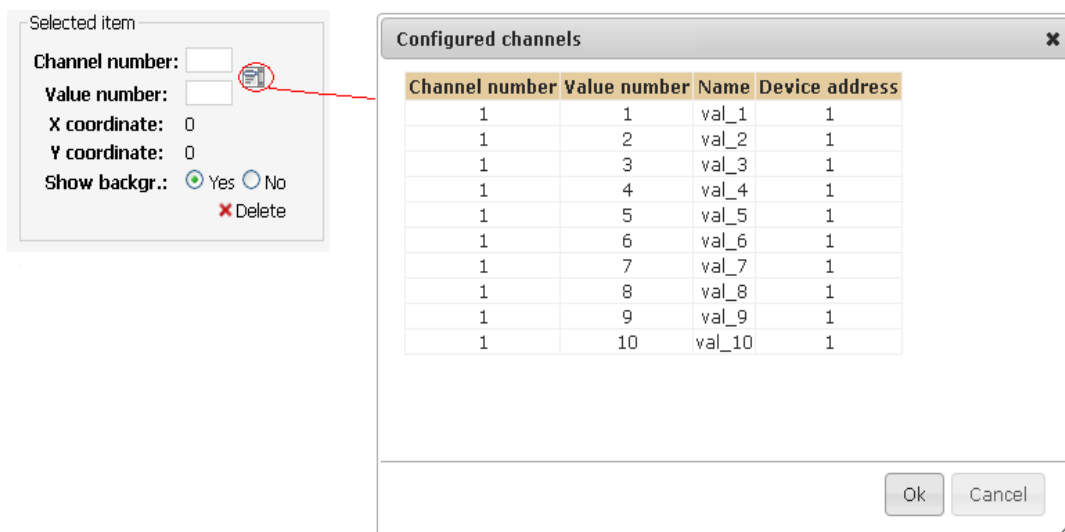

Fig. 53. Selecting a channel and value for an item

Selecting a value and clicking *Ok* fills values in the place of channel number and value number. An element can be moved by grasping an item with a mouse and inserting it in the right place. While moving it, current coordinates values are displayed.

There is also a possibility to set a yellow or a transparent background for an element (using an option *Show background*), fig. 54:

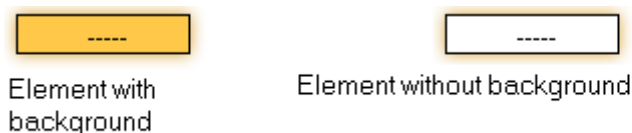

Fig. 54. Setting background for element

Element can be deleted by clicking *Delete*.

- d) Load/ save map - allows for saving a map and loading a previously saved synoptic map (fig. 55).

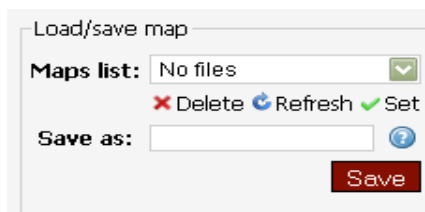

Fig. 55: Left menu of synoptic map - map loading and saving

If there are any created synoptic maps they can be opened by selecting a map from the list and clicking *Set*. The map can be deleted by clicking *Delete*. The map can be also saved by entering a name that is not longer than 8 characters (containing only letters, numbers and underliners) and clicking *Save*. Selecting *Refresh* will refresh the list of maps.

Right click on the main part of the site displays the context menu presented on the fig. 56:

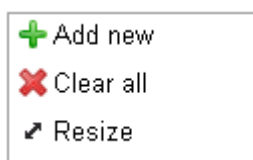

Fig. 56: Context menu of synoptic map

Selecting *Add new* adds a new element. Selecting *Clear all* deletes all elements and a background from a synoptic map. Selecting *Resize* displays a window presented on the fig. 57 that allows for changing size of a synoptic map.

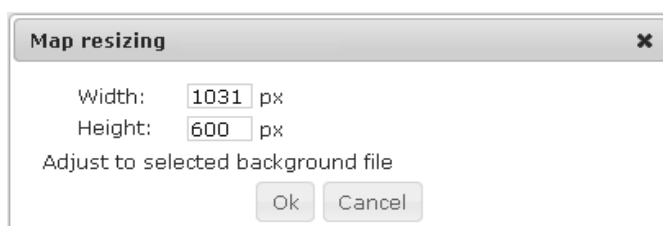

Fig. 57: Map resizing

Map size can be changed by entering width (maximum 2500 pixels) and height (maximum 1600 pixels) or by choosing the option *Adjust to selected background file* which enters given values.

Right click on an element displays the menu presented on the fig. 58:

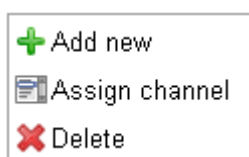

Fig. 58: Context menu of synoptic map element



Selecting *Add new* will add a new element to a map, selecting *Assign channel* will display a window allowing for selecting a channel value from the list of configured ones. Selecting *Delete* will delete a selected element.

#### 6.6.4. Serial port configuration

Serial port configuration allows for configuring such settings as Modbus Master, Modbus Slave and Modbus TCP Slave.

Going to serial port configuration is done by selecting *Configuration* from the site main menu and then *Serial port* from submenu according to fig. 59.

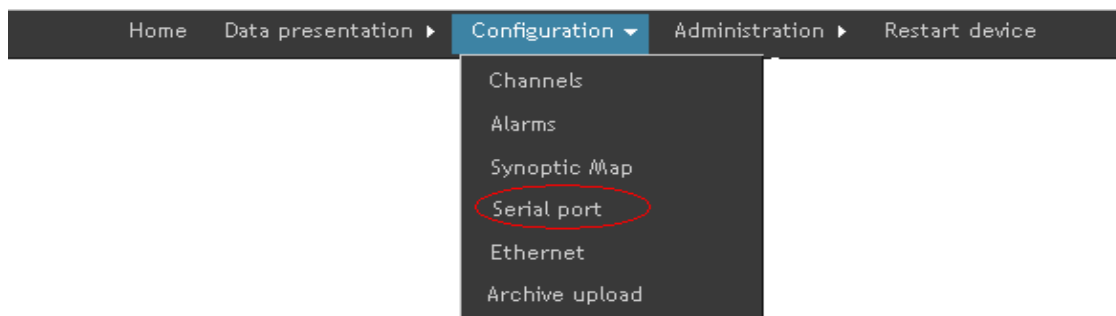

Fig. 59. Serial port configuration

After the site downloads its main part looks in the way presented on the fig. 60.

Serial port - configuration	
<b>Modbus Master</b>	
Baud rate:	9600 bit/s
Transmission mode:	RTU 8N1
<b>Modbus Slave</b>	
Device address [1-255]:	1
Baud rate:	9600 bit/s
Transmission mode:	RTU 8N1
<b>Modbus TCP Slave</b>	
Device address [1-255]:	255
Port number:	501
Maximum simultaneous connections [1-4]:	2
TCP port closing time [10s-600s]:	10
<b>Save</b>	

Fig. 60: Looks of serial port configuration

Modbus Master configuration allows for setting baud rate and transmission mode (table 11).

*Modbus Master settings**Table 11*

Name	Description
Baud rate	Modbus Master baud rate, can assume the following values: 1200 bit/s, 2400 bit/s, 4800 bit/s, 9600 bit/s, 19200 bit/s, 38400 bit/s, 57600 bit/s, 115200 bit/s
Transmission mode	Modbus Master transmission mode, the following values are possible 8N2, 8E1, 8O1, 8N1

Modbus Slave configuration allows for setting device address, baud rate and transmission mode (table 12).

*Modbus Slave settings**Table 12*

Name	Description
Device address	Device address, can assume values from 1 up to 255
Baud rate	Modbus Slave baud rate, can assume the following values: 1200 bit/s, 2400 bit/s, 4800 bit/s, 9600 bit/s, 19200 bit/s, 38400 bit/s, 57600 bit/s, 115200 bit/s
Transmission mode	Modbus Slave transmission mode, the following values are possible 8N2, 8E1, 8O1, 8N1

Modbus Slave TCP configuration allows for the settings of:

- device address,
- Modbus TCP port number,
- number of simultaneous connections with Modbus TCP server,
- TCP port closing time.

The description of the above parameters is presented in the table 13.

*Modbus Slave TCP settings**Table 13*

Name	Description
Device address	device address can assume values from 1 up to 254
Modbus TCP port number	Modbus TCP port number, can assume values from 10 to 1000
Maximum simultaneous connections	maximum number of simultaneous connections with Modbus TCP server, possible values from 1 up to 4
Port TCP closing time	setting port TCP closing time, possible values from 10 s up to 600 s

After changes one should left click Save to save all changes.



**Notice:**

**After changing the parameters the device should be reset.**

### 6.6.5. Ethernet configuration

Ethernet configuration allows for configuring IP settings and ports settings. Going to Ethernet configuration is done by selecting *Configuration* from the main menu and then selecting *Ethernet* from the submenu, according to fig. 61.

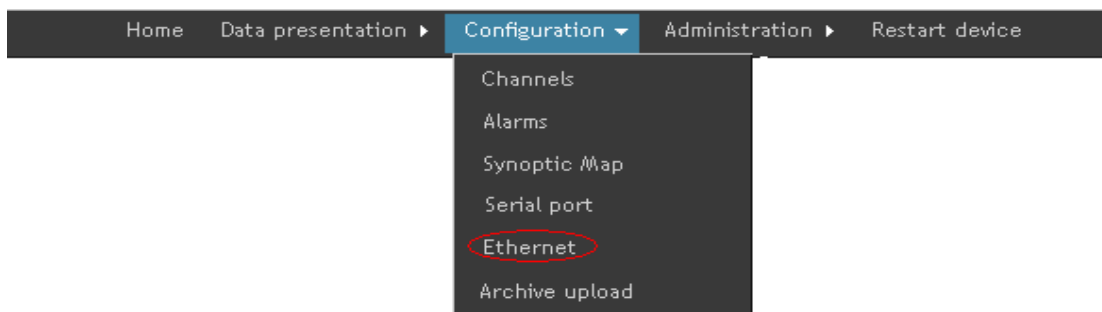

Fig. 61. Ethernet configuration

After the site downloads, the configuration window presented on the fig. 62 displays.

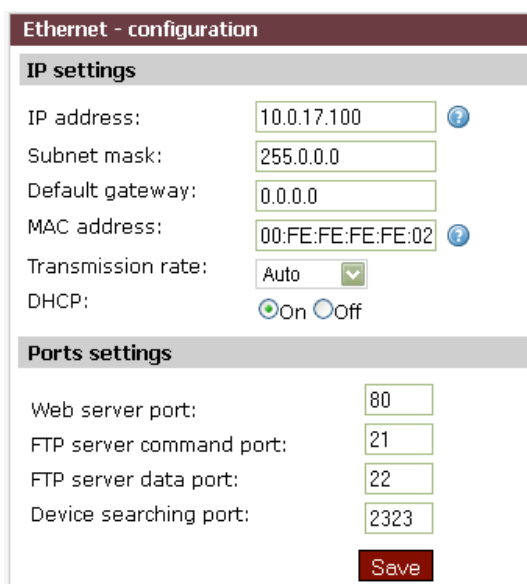

Fig. 62: The view of Ethernet configuration

In IP settings it is possible to configure the values presented in the table 14.

<i>IP settings</i>		<i>Table 14</i>
Name	Description	
IP address	IP address, address is in the fourth version IPv4	
Subnet mask	subnet mask	
Default gateway	default gateway	
MAC address	MAC address, MAC address is quoted in the format XX:XX:XX:XX:XX:XX	

Transmission rate	transmission rate on one of the options: - auto - 10Mbit - 100Mbit
DHCP	DHCP On or Off

It is possible to configure:

- web server port,
- FTP server command port,
- FTP server data port,
- number of device serving port.

Description of parameters is presented in the table 15.

Ports settings

Table 15

Name	Description
Web server port	number of web server port, possible values from 80 up to 65535
FTP server command port	number of FTP server command port, possible values from 20 up to 65535
FTP server data port	number of FTP server data port, possible values from 20 to 65535
Device searching port	number of device searching port, possible values from 10 up to 65535

After inserting changes they ought to be saved by clicking *Save*.



**Notice:**

**After changing the parameters the device should be reset.**

### 6.6.6. Archive uplaod

Archive upload allows to transfer files archived on remote FTP server. Going to archive upload is done by going to *Configuration* from the main menu and then selecting the *Archive uplad* as shown in fig. 63.

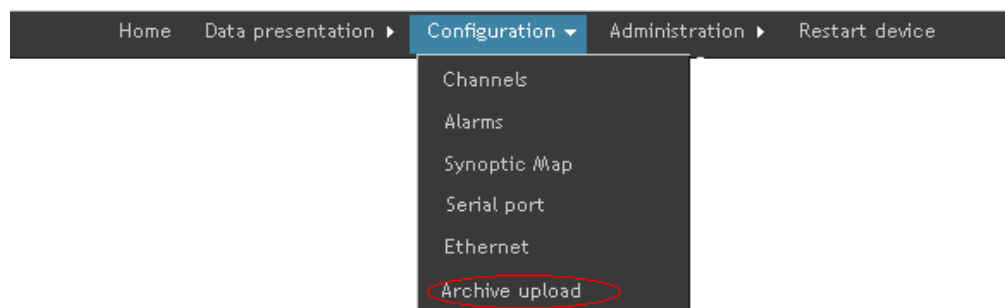
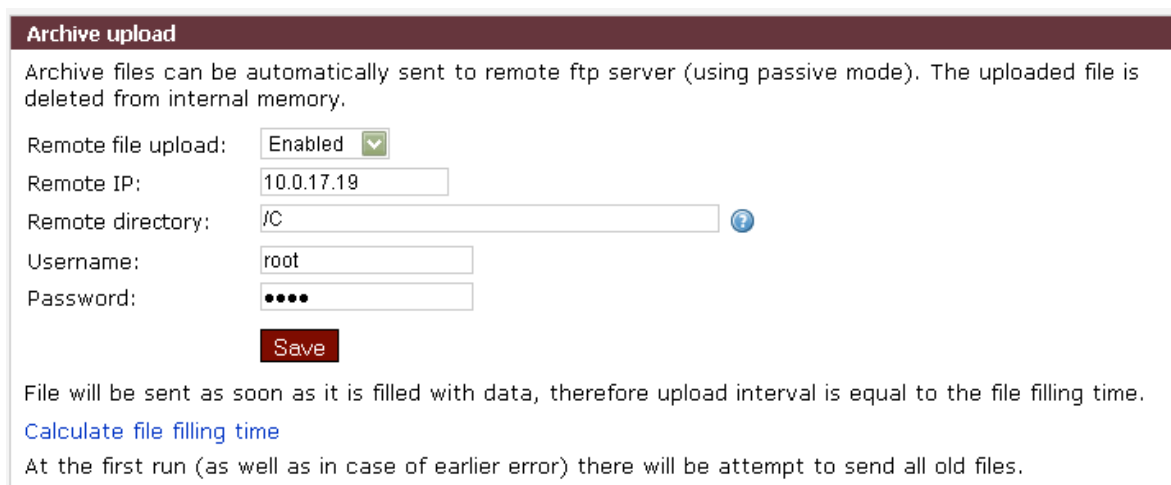

Fig. 63. Archive upload selection

The view of channel values presentation is presented on the fig. 64.



**Archive upload**

Archive files can be automatically sent to remote ftp server (using passive mode). The uploaded file is deleted from internal memory.

Remote file upload:

Remote IP:

Remote directory:  ⓘ

Username:

Password:

File will be sent as soon as it is filled with data, therefore upload interval is equal to the file filling time.  
[Calculate file filling time](#)

At the first run (as well as in case of earlier error) there will be attempt to send all old files.

Fig. 64: Archive upload presentation

To send files via FTP specify the IP address of the remote server and the directory path and the username and password. Archive files will be sent only after filling.

## 6.7. Data presentation

Data presentation allows for browsing the current data being loaded from SM61IoT data logger. Data presentation is possible after prior proper device configuration. The measurement value in a given channel is the last correct value read out from the device.

### 6.7.1. Channels values presentation

Moving on to channels values presentation is done by selecting *Data presentation* from the main menu and then the option *Channel values* from the submenu as presented on the fig. 65.

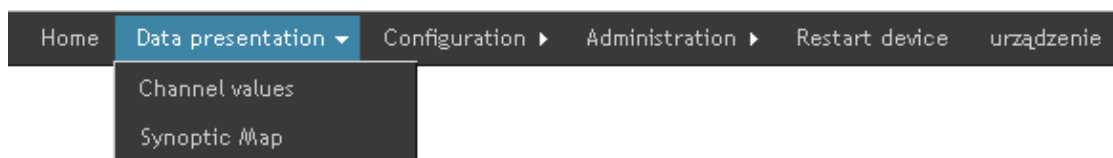

Fig. 65. Channel values presentation

The view of channel values presentation is presented on the fig. 66.

**General data**

Name: SM61  
 IP: 192.168.1.1  
 Username: root  
 Used space: 2%

**Channel values**

Control

Configuration: Refresh  
 Refreshing: STOP  
 Last measurement: ----  
 Chart: Show

Channel number	Value number	Device address	Register address	Register type	Name	Value	Add to the chart	Status
1	1	1	8000	float4321	val_1		<input type="checkbox"/>	
	2	1	8002	float4321	val_2		<input type="checkbox"/>	
	3	1	8004	float4321	val_3		<input type="checkbox"/>	
	4	1	8006	float4321	val_4		<input type="checkbox"/>	
	5	1	8008	float4321	val_5		<input type="checkbox"/>	
	6	1	8010	float4321	val_6		<input type="checkbox"/>	
	7	1	8012	float4321	val_7		<input type="checkbox"/>	
	8	1	8014	float4321	val_8		<input type="checkbox"/>	
	9	1	8016	float4321	val_9		<input type="checkbox"/>	
	10	1	8018	float4321	val_10		<input type="checkbox"/>	

Fig. 66: Channel values presentation

It is possible to control the data presentation using the option of the left menu of the site as presented on the fig. 66. The menu contains the following elements:

- Configuration – allows for refreshing the configuration,
- Refreshing – allows for setting the values refreshment on a site. Available values: 2s, 5s, 10s and 60s and STOP to stop data downloading.
- Last measurement – presents the time of last measurement made, the sign is green during read out, when refreshing is set on STOP the sign will turn red,
- Chart – clicking on *Show* displays the chart.

The table presented on the fig. 66 contains the following information:

- channel number from which data will be downloaded,
- value number of a given channel,
- device address from which data is downloaded,
- register address,
- register type,
- value name,
- value - current value with a unit, when refreshing is not turned on this column is empty, the value appears after turning on refreshing,
- add to the chart - highlighting this option adds a selected value to the presentation on the chart,
- status.

In case a channel has more than one value it is possible to collapse the view so that only the first channel value can be visible (fig. 67).

Collapse ▲	number	Value number	Device address	Register address	Register type	Name	Value	Add to the chart	Status
1	1	1	1	8006	float4321	val_1	4.94	<input type="checkbox"/>	
	2	1	1	8008	float4321	val_2	0.00	<input type="checkbox"/>	
	3	1	1	8010	float4321	val_3	0.00	<input type="checkbox"/>	
	4	1	1	8012	float4321	val_4	0.00	<input type="checkbox"/>	
	5	1	1	8014	float4321	val_5	0.00	<input type="checkbox"/>	●
	6	1	1	8016	float4321	val_6	0.84	<input type="checkbox"/>	
	7	1	1	8018	float4321	val_7	0.01	<input type="checkbox"/>	
	8	1	1	8020	float4321	val_8	0.01	<input type="checkbox"/>	
	9	1	1	8022	float4321	val_9	0.01	<input type="checkbox"/>	
	10	1	1	8024	float4321	val_10	0.00	<input type="checkbox"/>	

Collapse ▲	number	Value number	Device address	Register address	Register type	Name	Value	Add to the chart	Status
1	1	1	1	8006	float4321	val_1	4.94	<input type="checkbox"/>	●

Fig. 67: Collapsing of channel values

The chart presents the values highlighted with the option *Add to the chart*. The chart is presented on the fig. 68. The chart presents last 30 values. The chart has its legend. After placing a mouse cursor on a value it becomes highlighted and the information containing basic data on a given value is displayed, these are:

- name,
- size,
- downloading time.

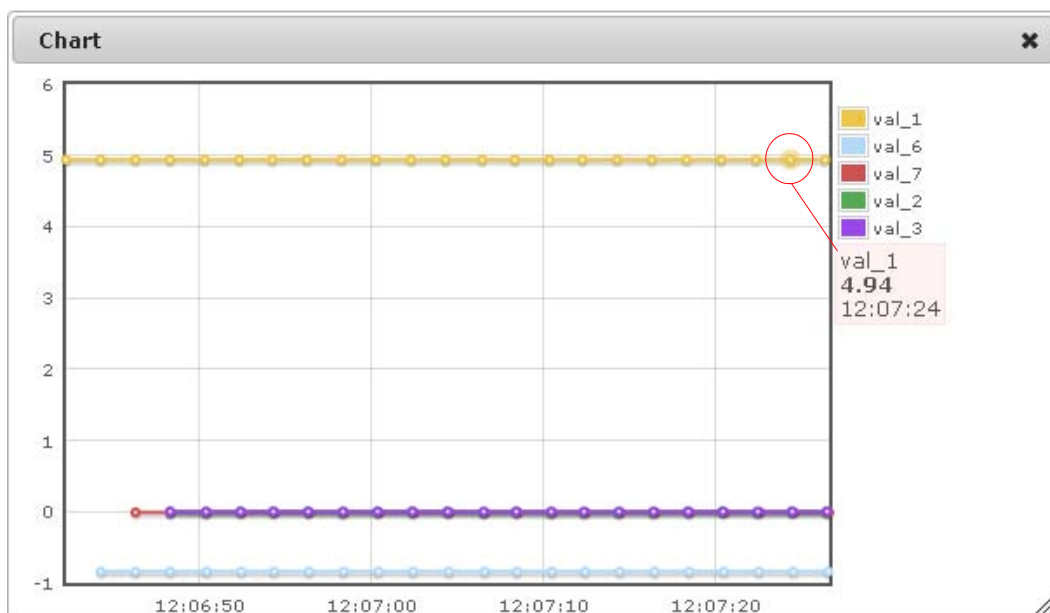

Fig. 68: Value chart

### 6.7.2. Synoptic map presentation

Moving on to synoptic map presentation is done by selecting *Data presentation* from the site main menu and then *Synoptic map* as presented on the fig. 69.

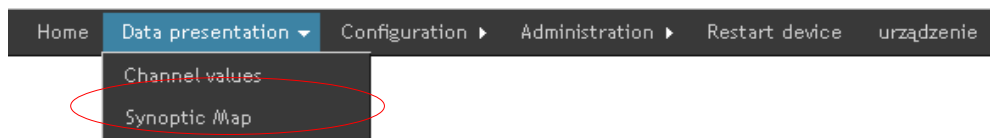

Fig. 69. Synoptic map presentation

The view of channel values presentation is shown on the fig. 70.

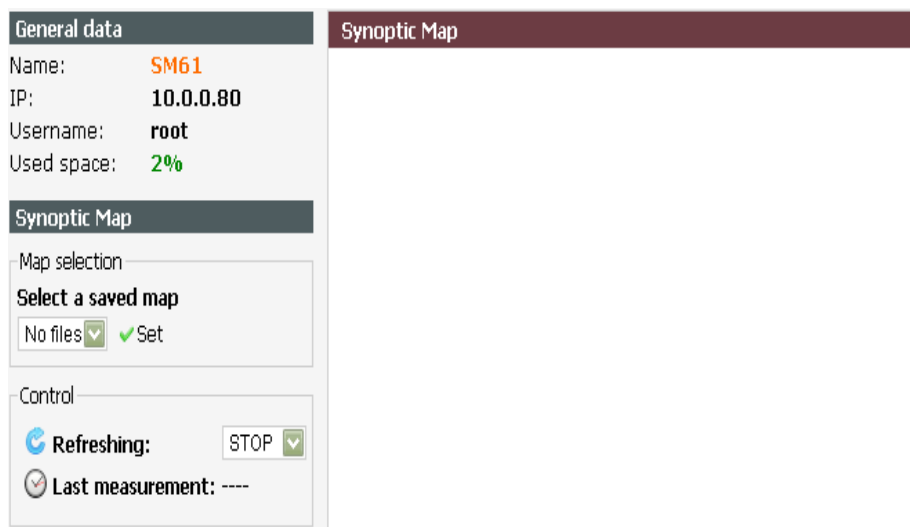

Fig. 70: Synoptic map presentation

At first select a saved synoptic map and click *Set* (fig. 70). Then set refreshing which is set by default on STOP, it can be set on 2s, 5s, 10s, 60s. After setting the time of data refreshing, current data being downloaded from a device will start appearing on the site. The left menu also displays the time of last measurement, during downloading it displays in green, after downloading is off, it displays in red.

Placing a mouse cursor on an element displays a window presenting such information on an element as:

- name,
- channel number,
- value number,
- unit.

## 6.8. Language change

The change of a language is done by selecting a flag that represents a language (fig. 71). An active language version is presented by a colourful flag, inactive version by a black and white flag.



Fig. 71. Language change



## 7. FTP Client

The SM61IoT data logger enables communication by FTP protocol. You can get to files using standard program of FTP protocol client, website (to download archive files) and using SM61Config software (to download archive). To connect with a device using FTP client you need:

- IP address - IP address setting is described in point [6.6.5.Ethernet configuration](#),
- number of FTP server command port - setting a port number is described in point [6.6.5. Ethernet configuration](#),
- number of FTP server data port - setting a port number is described in the point [6.6.5. Ethernet configuration](#),
- user name and password - a user set by default (the same as for Internet browser) :

**login:** root

**password:** dbps

For safety reasons a user ought to be changed for other than a default one, which is presented in the point [6.5.3. Users](#). The example of making a connection using FileZilla client (you can download FileZilla from <http://filezilla-project.org>) is presented on the fig. 72.

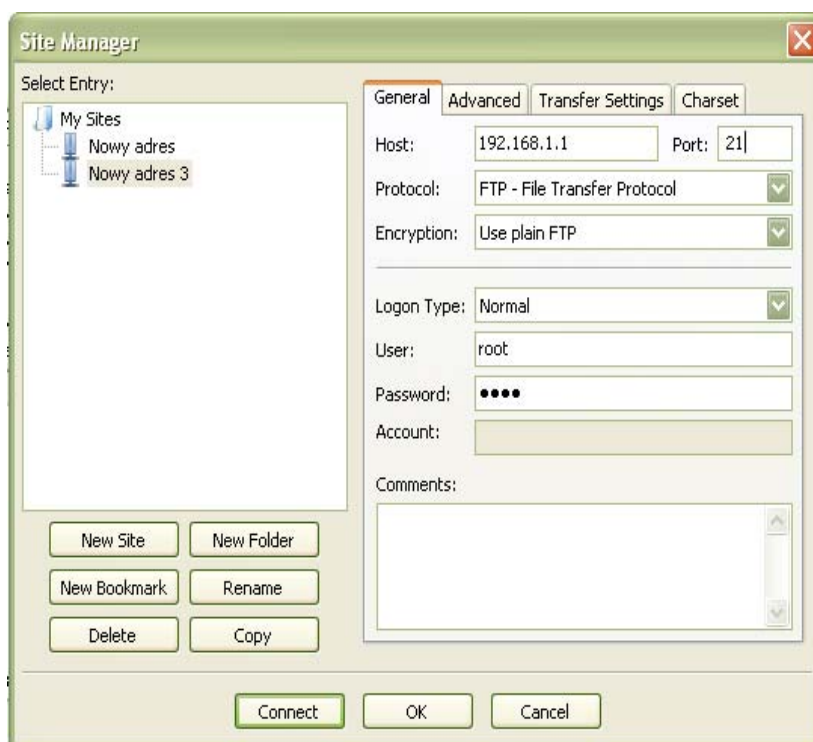

Fig. 72: Making connection with FTP server

For data transmission, maximum one connection at the same time is possible (in FileZilla a new site ought to be added and a number of simultaneous connections ought to be set on one- fig. 73). Copying is to be done in a binary mode.

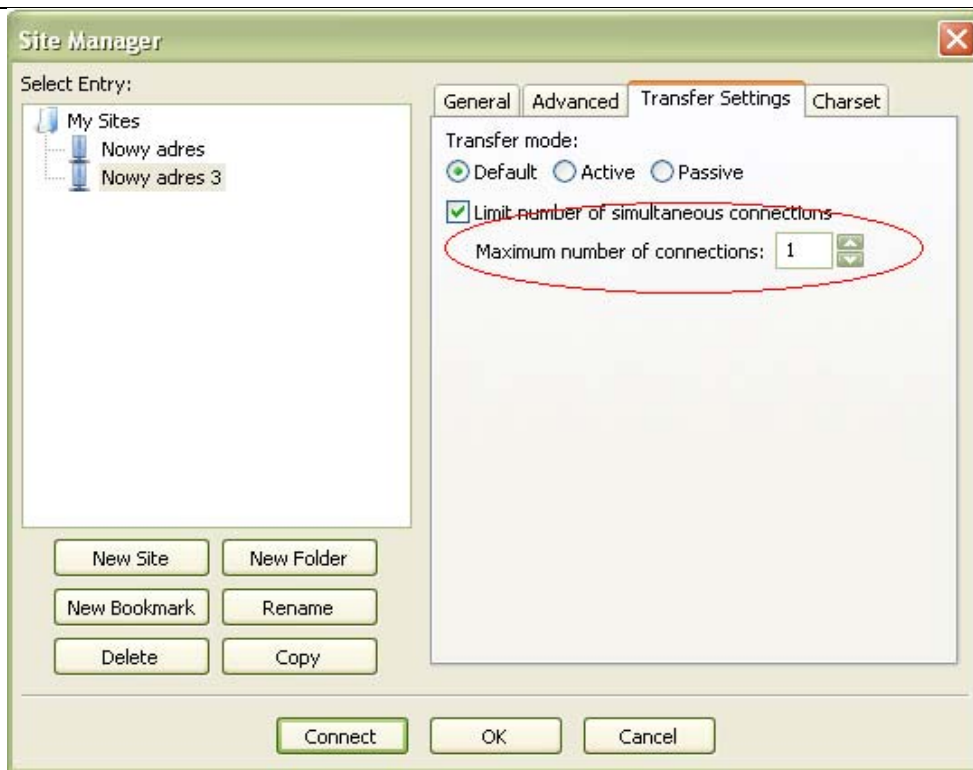

Fig. 73: Setting a limit of connections in FileZilla

The SM61IoT data logger has a folder structure presented on the fig. 74.

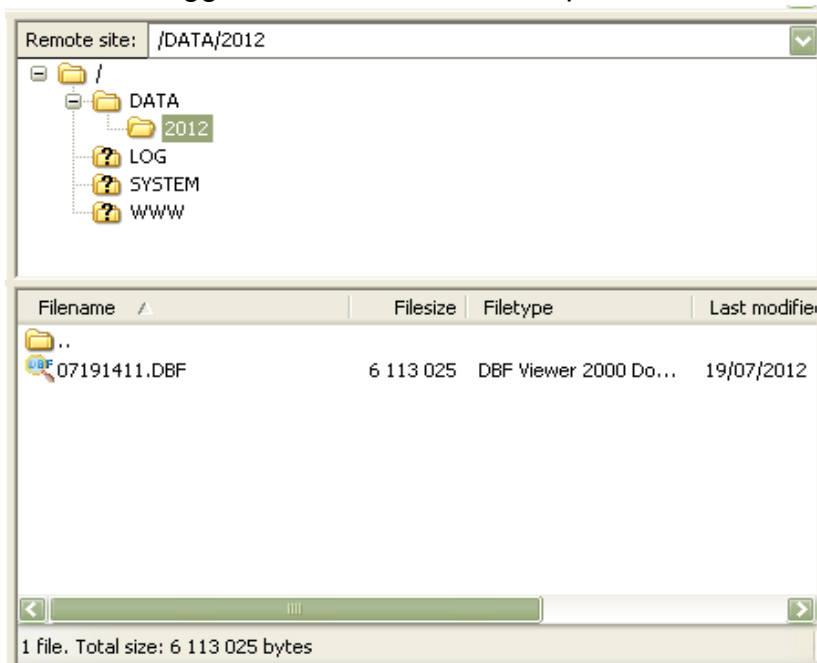

Fig. 74: Catalog structure

Individual folders contain:

- DATA - contains files with archive data,
- LOG - contains files with logs,
- SYSTEM - contains files with configuration,
- WWW - contains files with web site.

## 8. Configuration of MQTT

### 8.1 Protocol description

The protocol uses a publishing and subscription architecture as opposed to the HTTP protocol that performs data exchange in a demand-response manner. Publishing or subscribing is controlled by events and allows messages to be transferred to distributed clients. The central point of communication is the MQTT broker - a server responsible for sending all messages between senders and recipients. Client who publishes a message to the broker adds a specific topic to the message being sent. The subject is information for the broker about data routing. Every client who wants to receive messages subscribes to a specific name/topic and the broker delivers all messages according to the matching topic to the client. Therefore, clients do not need to know each other, they only communicate on a pre-determined address. This architecture enables highly scalable solutions without dependencies between data senders and recipients. The SM61 IoT device allows for transfer of process data in the MQTT protocol, which has been previously read from connected MODBUS slave devices. The data is grouped under one MODBUS device configured according to the channel configuration and sent to the broker server. The frame structure on the example of reading measurement data from the P18D device is shown and described below in Fig. 75

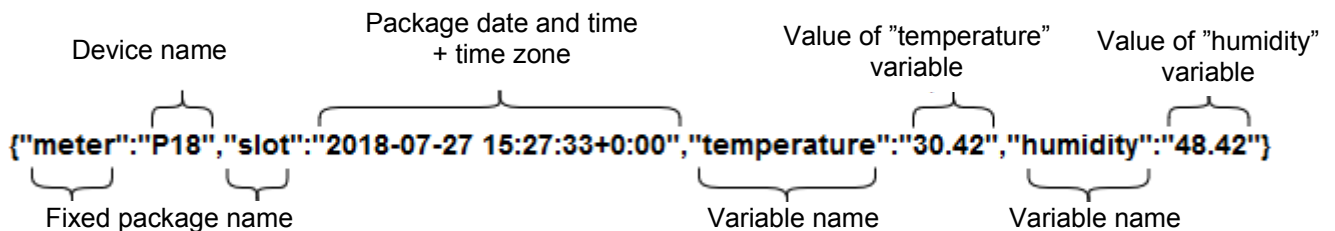

Fig. 75: Structure of the MQTT package

### 8.2 Configuration of the MQTT module

The Ethernet configuration page in addition to configuring IP settings and port settings, provides settings for the MQTT module. The transition to the Ethernet configuration takes place by going to the *Configuration* option from the main menu and then selecting the *Ethernet* option according to Fig. 76.

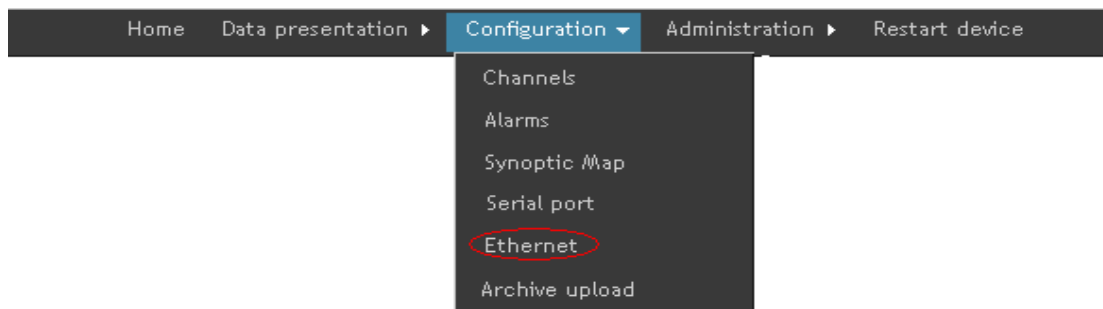

Fig. 76: Ethernet configuration (of MQTT communication)

After the page loads, the configuration window shown in Fig. 77 appears, along with the MQTT settings:

**Ethernet - configuration**

**IP settings**

IP address:  ?

Subnet mask:

Default gateway:

DNS server:

MAC address:  ?

Transmission rate:  ▾

DHCP:  On  Off

**Ports settings**

Web server port:

FTP server command port:

FTP server data port:

Device searching port:

**MQTT settings**

Server address:  ?

Topic:   On/Off ?

Port number:

Keepalived:  [s]

Polling interval:  [s]

MQTT:  On  Off

Fig. 77: View of MQTT settings configuration

In the MQTT settings it is possible to configure the following values shown in Table 16.

Parameter name	Description
Server address	IP address of the MQTT server, the address is in the fourth version of IPv4

IP settings

Table 16

Topic	Title name of the message being sent. If the MQTT service is enabled and the title is switched off, the title value is taken from the channel settings, Modbus device name
Port number	The communication port number to which the MQTT service has been assigned
Hold time	Time to check the opening of the data exchange port
IPolling interval	The period of publishing data to the blocker
MQTT	enabling or disabling the MQTT service

After making changes, save them by clicking the *Save* button.



**Caution :**

**After changing the parameters, the device must be restarted .**

## 9. Internal archive

The SM61IoT allows to store data read from Slave devices. Current data read from channel values or current data read and calculated using mathematical functions are saved in the archive. Only values of these channels which mode is set on archived or full are archived.

Archive files are created in DBF format, in folder DATA and in a subfolder with a year in which a file was created (folders structure is presented in the point [7.FTP Client](#)). Number of files in a directory with the name of the year is limited to 2000, when the number of files is exceeded archiving will be stopped until you delete the files. File name with archive data contains date and time of a file creation in format MMDDGGMinMin.DBF, where:

- MM - means a month of a file creation written down using a two-digit number,
- DD - means a day of a file creation written down using a two-digit number,
- GG - means an hour of a file creation written down using a two-digit number,
- MinMin - means a minute of a file creation that is written down using a two-digit number.

More information about a file structure can be find in the point [8.3.Structure of archive file](#). Archive can be read, copied and deleted. Archive is created for the defined number of records which is possible to set (details in archiving configuration - point [6.5.1. General settings](#)). When all archive files are deleted, a new file in accordance with current archive settings is created and all data is saved in it.

Before modifying the archive configuration it is recommended to copy all archive files and then delete the whole archive. After the settings modification, the files with current settings will be created. All errors are signaled with REC diode (fig. 3, red REC diode - archiving error, green - correct archiving), with channel statuses (table 21) and with logs saved in data logger memory (available to load via FTP protocol or load via website – point [6.5.4. Event log](#)).

### 9.1. Archiving configuration

During configuration, it is needed to configure the channels which will be archived (during channels configuration), then set how many records an archive file will contain. It is possible to set from 20 up to 32000 records in a file. Records are archived with a

time step which also needs to be set on values from 10 to 65535 seconds (channel configuration). A required archiving time need to be rounded to 10, because entering a different value will round it up anyway.

Archiving mode is also to be set on one of the available alternatives:

- off,
- on,
- triggered by alarm 1 (for the implementation with alarms),
- triggered by alarm 2 (for the implementation with alarms),
- triggered with input 1 (for the implementation with inputs),
- triggered with input 2 (for the implementation with inputs),

New number of records in a file will be set only after the device restart. If a new number of records is set on greater than the previous one the last file will be closed and a new one with a proper number of records will be created. However, if a new number of records was set on smaller than the previous one, there are three possibilities. If the file is not full:

- if the number of records in file is less than the new number of records, file is filled to the new number of records and then shuts down and creates a new,
- if the number of record in file is larger than the new number of records, file is closed and the new one is created.

However, if file is full, it is closed and new one is created with the appropriate amount.

Setting conditional archiving can be done in one of four options presented on the fig. 75. Markings on the fig. 75:

- Ar\_L – Lower archive threshold – Register 4083/4073,
- Ar\_H – Upper archive threshold – Register 4084/4074.

Continuous archiving is turned on by selecting h-on archiving mode (turned on by hand), archiving is turned off by selecting h-off (turned off by hand).

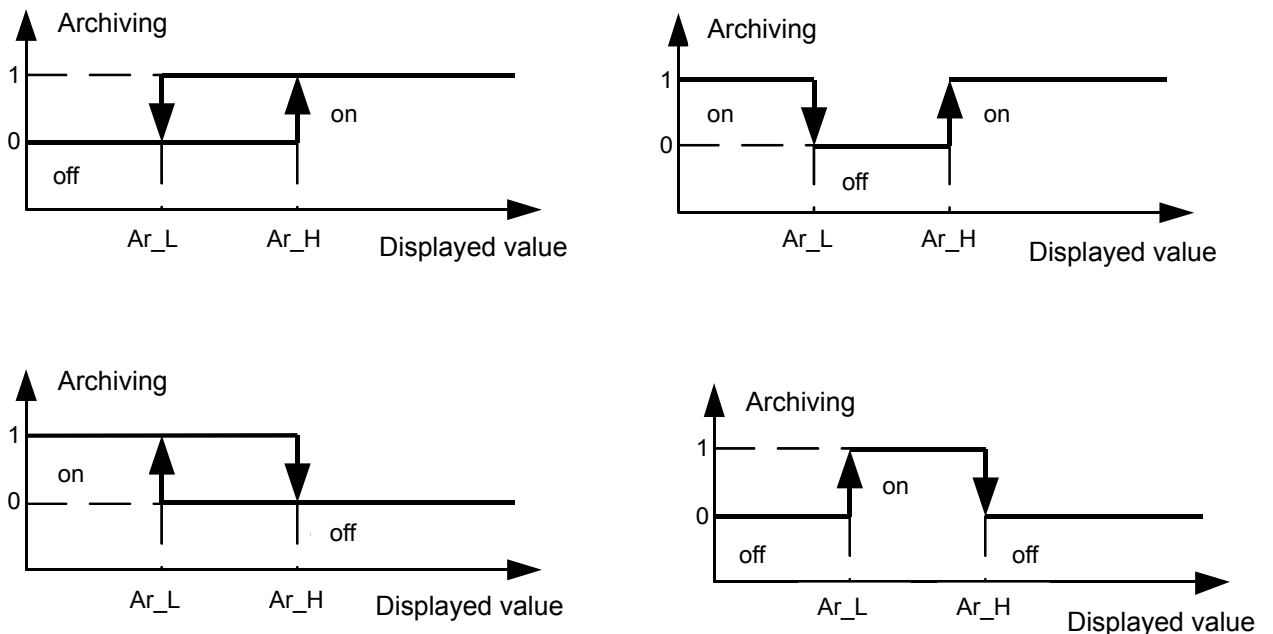

Fig. 75: Types of conditional archiving

## 9.2. Downloading archive data

Downloading archive data from a data logger memory can be done using:

- FTP client - it allows to download the entire contents of the card,
- website (point [6.6.6. Archive upload](#)) - it allows to download only archive files.

How to use FTP client is presented in point [7. FTP Client](#). Connect device by FTP client and then download archive files. The folder structure is presented on the fig. 76.

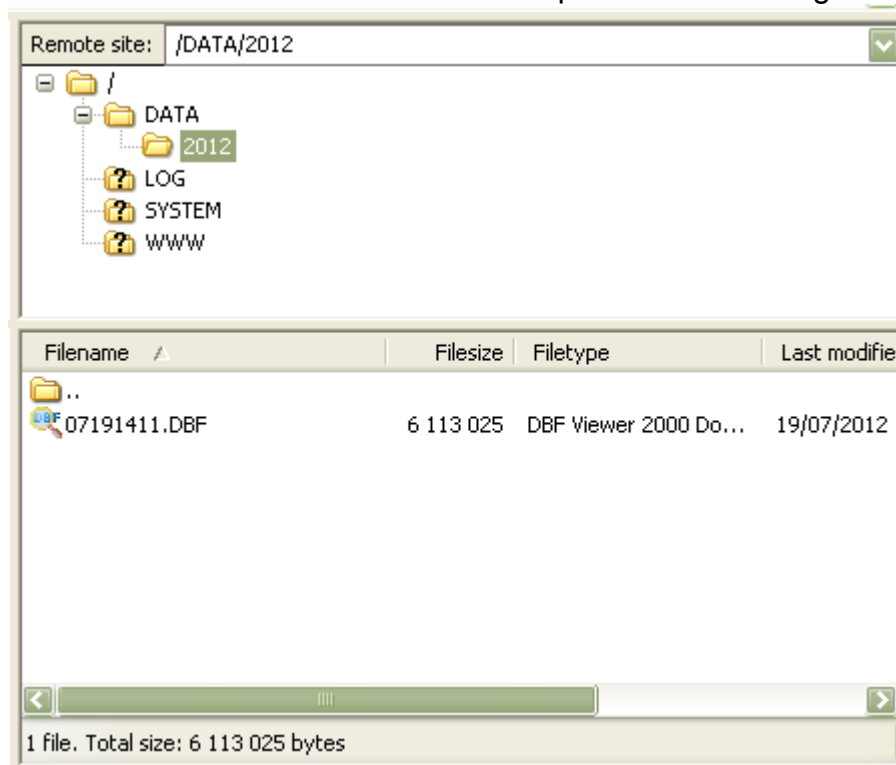

Fig. 76: Downloading archive from data logger

## 9.3. Structure of archive files

Files with archive data are saved in DBF format. To open them, use the program that opens this type of files, e.g. OpenOffice Calc, MS Excel.

A file is created for a given number of records, it has a column structure and always consists of 31 columns. An exemplary file is presented on the fig. 77.

9.0	INDEX_NO	9.0	CHAN_NO	9.0	VAL_TYP	9.0	VAL_STAT	ab	DATE	ab	TIME	9.0	VAL_1	9.0	VAL_2	9.0	VAL_3	9.0	VAL_4	9.0	VAL_5	9.0	VAL_6	9.0	VAL_7
✓	1		1		6		1		2012-03-09		09:22:48		2.5000		1.2999		6.8000		5.0000		4.5000		3.0000		2.0000
✓	2		2		6		1		2012-03-09		09:22:48		2.5000		1.2999		6.8000		5.0000		4.5000		3.0000		2.0000
✓	3		3		6		1		2012-03-09		09:22:48		2.5000		1.2999		6.8000		5.0000		4.5000		3.0000		2.0000
✓	4		4		6		1		2012-03-09		09:22:48		2.5000		1.2999		6.8000		5.0000		4.5000		3.0000		2.0000
✓	5		5		6		1		2012-03-09		09:22:48		2.5000		1.2999		6.8000		5.0000		4.5000		3.0000		2.0000
✓	6		6		6		1		2012-03-09		09:22:48		2.5000		1.2999		6.8000		5.0000		4.5000		3.0000		2.0000
✓	7		7		6		1		2012-03-09		09:22:48		2.5000		1.2999		6.8000		5.0000		4.5000		3.0000		2.0000
✓	8		8		6		1		2012-03-09		09:22:48		2.5000		1.2999		6.8000		5.0000		4.5000		3.0000		2.0000
✓	9		9		6		1		2012-03-09		09:22:48		2.5000		1.2999		6.8000		5.0000		4.5000		3.0000		2.0000
✓	10		10		6		1		2012-03-09		09:22:48		2.5000		1.2999		6.8000		5.0000		4.5000		3.0000		2.0000
✓	11		11		6		1		2012-03-09		09:22:48		2.5000		1.2999		6.8000		5.0000		4.5000		3.0000		2.0000
✓	12		12		6		1		2012-03-09		09:22:48		2.5000		1.2999		6.8000		5.0000		4.5000		3.0000		2.0000
✓	13		13		6		1		2012-03-09		09:22:48		2.5000		1.2999		6.8000		5.0000		4.5000		3.0000		2.0000
✓	14		14		6		1		2012-03-09		09:22:48		2.5000		1.2999		6.8000		5.0000		4.5000		3.0000		2.0000
✓	15		15		6		1		2012-03-09		09:22:48		2.5000		1.2999		6.8000		5.0000		4.5000		3.0000		2.0000
✓	16		16		6		1		2012-03-09		09:22:48		2.5000		1.2999		6.8000		5.0000		4.5000		3.0000		2.0000
✓	17		17		6		1		2012-03-09		09:22:48		2.5000		1.2999		6.8000		5.0000		4.5000		3.0000		2.0000
✓	18		18		6		1		2012-03-09		09:22:48		2.5000		1.2999		6.8000		5.0000		4.5000		3.0000		2.0000
✓	19		19		6		1		2012-03-09		09:22:48		2.5000		1.2999		6.8000		5.0000		4.5000		3.0000		2.0000
✓	20		20		6		1		2012-03-09		09:22:48		2.5000		1.2999		6.8000		5.0000		4.5000		3.0000		2.0000
✓	21		21		6		1		2012-03-09		09:22:48		2.5000		1.2999		6.8000		5.0000		4.5000		3.0000		2.0000
✓	22		22		6		1		2012-03-09		09:22:48		2.5000		1.2999		6.8000		5.0000		4.5000		3.0000		2.0000
✓	23		23		6		1		2012-03-09		09:22:48		2.5000		1.2999		6.8000		5.0000		4.5000		3.0000		2.0000
✓	24		24		6		1		2012-03-09		09:22:48		2.5000		1.2999		6.8000		5.0000		4.5000		3.0000		2.0000
✓	25		25		6		1		2012-03-09		09:22:48		2.5000		1.2999		6.8000		5.0000		4.5000		3.0000		2.0000
✓	26		26		6		1		2012-03-09		09:22:48		2.5000		1.2999		6.8000		5.0000		4.5000		3.0000		2.0000
✓	27		27		6		1		2012-03-09		09:22:48		2.5000		1.2999		6.8000		5.0000		4.5000		3.0000		2.0000
✓	28		28		6		1		2012-03-09		09:22:48		2.5000		1.2999		6.8000		5.0000		4.5000		3.0000		2.0000
✓	29		29		6		1		2012-03-09		09:22:48		2.5000		1.2999		6.8000		5.0000		4.5000		3.0000		2.0000
✓	30		30		6		1		2012-03-09		09:22:48		2.5000		1.2999		6.8000		5.0000		4.5000		3.0000		2.0000
✓	31		31		6		1		2012-03-09		09:22:48		2.5000		1.2999		6.8000		5.0000		4.5000		3.0000		2.0000
✓	32		32		6		1		2012-03-09		09:22:48		2.5000		1.2999		6.8000		5.0000		4.5000		3.0000		2.0000
✓	33		33		6		1		2012-03-09		09:22:48		2.5000		1.2999		6.8000		5.0000		4.5000		3.0000		2.0000
✓	34		34		6		1		2012-03-09		09:22:48		2.5000		1.2999		6.8000		5.0000		4.5000		3.0000		2.0000

Fig. 77: Exemplary file with data

Consecutive fields in a line have the following meaning:

- INDEX\_NO - stands for a record number in a file,
- CHAN\_NO - stands for a channel number,
- VAL\_TYP - stands for values according to register type (char, unsigned char, short, unsigned short, long, unsigned long, float1234, float4321- according to registers type in table 8),
- VAL\_STAT - stands for values (where 1 means ok, and 3 timeout, 2 means readout error),
- DATE - stands for a date of registered data,
- TIME - stands for time of registered data (hour, minute, second),
- VAL\_1,...,VAL\_25 - stands for a value read out from individual values.

## 10. Alarms and binary inputs

The SM61IoT data logger has two alarm relay outputs with a make contact or two binary inputs (depending on ordering code). Each output can operate in one of six modes. Fig. 78 presents the output in modes: n-on, n-off, on,off. The two remaining modes: h-on and h-off mean always on and always off. These modes are meant for manual stimulation of alarms.

AL\_L - Lower alarm threshold

AL\_H - Upper alarm threshold

**Note:** For alarm types: n - on, n - off, on, off entering PrL>PrH turns off an alarm.

In case of implementation with binary inputs, possibility of defining adequate functions for each of inputs individually:

- lack of function,



- turning on MODBUS RTU module for Master mode for low level,
- turning on MODBUS RTU module for Master mode for high level,
- turning off MODBUS RTU module for Master mode for low level,
- turning off MODBUS RTU module for Master mode for high level,
- turning on archiving module for low level,
- turning on archiving module for high level,
- turning off archiving module for low level,
- turning off archiving module for high level,
- deleting archive for low level,
- deleting archive for high level.

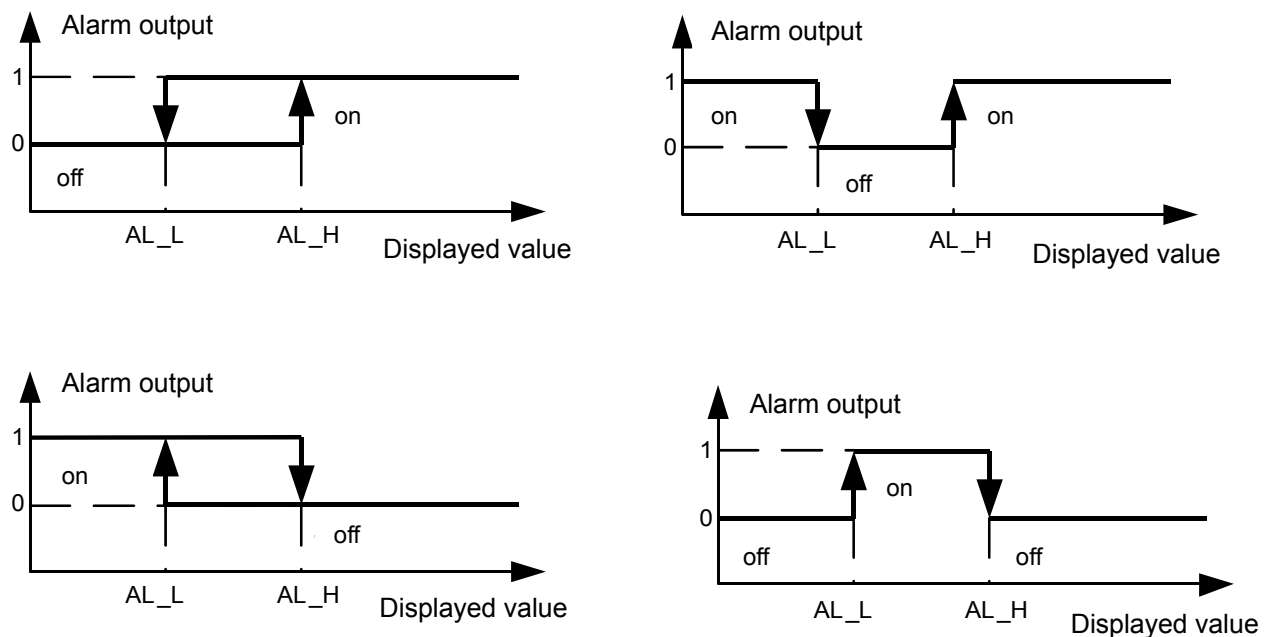

Fig. 78: Alarms work in different modes

## 11. Interface RS-485

The SM61IoT has a serial connection in RS-485 standard to communicate in computer and with other Master devices. MODBUS asynchronous character communication protocol was implemented on a serial connection. Transmission protocol describes the way of information exchange between devices using a serial connection. Implemented protocol is in accordance with PI-MBUS-300 Rev G of Modicon. Point [6.6.4. Serial port configuration](#) shows configuration of serial port settings.

### 11.1. Description of functions

The functions of Modbus protocol which has been implemented in SM61IoT data logger are shown in table 16.

Modbus protocol functions Table 17

Code	Meaning
03	Reading n-registers
04	Reading n input registers
06	Record 1 register
16	N-registers record

### N-registers reading (code 03)

#### Request:

The function allows for reading values in registers in an addressed Slave device. **There are 16 or 32-bit registers which can contain numeric values connected with process variables etc.** A claim frame defines a 16-bit initial address of a register and a number of registers to be read. The function is not available in broadcast mode.

Example. Read of 2 registers, starting from a register with address 1DB0h (7600) type float (32 bits).

Device address	Function	Register address		Register number		Checksum CRC
		Hi	Lo	Hi	Lo	
01	03	1D	B0	00	02	C3 80

#### Response:

Registers data are packed starting from the smallest address: first high byte and then junior byte of a register.

Example. Response frame.

Device address	Function	Number of bytes	Value from register 1DB0 (7600)				Value from register 1DB1 (7601)				Checksum CRC
			MSB			LSB	MSB			LSB	
01	03	08	41	20	00	00	42	C8	00	00	E4 6F

### N- input registers reading (code 04)

#### Request:

The function allows for reading values in registers in an addressed Slave device, similar as function 03.

Example. Read of 2 registers, starting from a register with address 1DB0h (7600) type float (32 bits).

Device address	Function	Register address		Register number		Checksum CRC
		Hi	Lo	Hi	Lo	
01	4	1D	B0	00	02	C3 80

**Response:**

Registers data are packed starting from the smallest address: first high byte and then junior byte of a register.

Example. Response frame.

Device address	Function	Number of bytes	Value from register 1DB0 (7600)				Value from register 1DB1 (7601)				Checksum CRC
			MSB			LSB	MSB			LSB	
01	4	08	41	20	00	00	42	C8	00	00	E4 6F

**Recording a value into a register (code 06)****Request:**

The function allows for modification of a register content. It is available in broadcast mode.

Example. Recording value 543 (0x021F) into register 4001 (0x0FA1).

Device address	Function	Register address		Register value		Checksum CRC
		Hi	Lo	Hi	Lo	
01	06	0F	A1	02	1F	9B 94

**Response:**

Message retransmission after carrying out the operation is a correct response for a claim of value recording into a register.

Example.

Device address	Function	Register address		Register value		Checksum CRC
		Hi	Lo	Hi	Lo	
01	06	0F	A1	02	1F	9B 94

**N-registers record (code 16)****Request:**

Function available in broadcast mode. It allows for modifications of registers content.

Example. Recording of two registers, starting from register with address: 1DB0h(7600). Recorded values are: 20 and 200.

Device address	Function	Register addresses		No. of registers		No. of bytes	Value for register 1DB0				Value for register DB1				Checksum CRC
		Hi	Lo	Hi	Lo		MSB			LSB	MSB			LSB	
01	10	1D	B0	00	02	08	41	A0	00	00	43	48	00	00	C9 E2

**Response:**

A correct response includes:

- Slave unit address,
- function code,
- initial address,
- number of recorded registers.

Example.

Device address	Function	Register address		Register value		Checksum CRC
		Hi	Lo	Hi	Lo	
01	10	1D	B0	00	02	46 43

## 11.2. Error codes

When Master device sends a request to Slave device, it expects a correct response, except messages sent in broadcast mode. After sending a Master unit request, four possible events may occur:

- If a Slave unit receives a request without a transmission error and it can carry it out correctly, then it returns a correct response.
- If a Slave unit does not receive a request, no response is returned. In Master device program, the timeout conditions for a request will be fulfilled.
- If a Slave unit receives a request but it comes with transmission errors (parity error, checksum LRC error or CRC error), no response is returned. In Master device program, the timeout conditions for a request will be fulfilled.
- If a Slave unit receives a request without a transmission error but it cannot carry it out correctly (e.g. if a request is a readout of a non-existing bit output or a register), then it returns a response containing an error code which informs a Master device on an error cause.

The message with a wrong response contains two fields that distinguish it from a correct response:

- **Function code field**

In a correct response, a Slave unit retransmits a function code from a request message to the field of response function code.

All functions codes have most significant bit (MSB) that equals 0 (codes values are below 80h).

In a wrong response, a Slave device sets a most significant bit of function code to 1. This causes a function value code in a wrong response to be exactly 80h bigger than it would be in a correct response.

On the basis of a function code with set MSB, Master device program may recognize a wrong response and may check an error code in a data field.

- **Data field:**

In a correct response, a Slave device may return data in the data field (some information requested by Master unit).

In a wrong response, a Slave device returns an error code in a data field. It defines Slave device conditions that caused an error.

Table 17 presents possible error codes and their meaning.

*Error codes* *Table 18*

Code	Meaning
01	Function not allowed
02	Illegal data address
03	Data value not allowed
04	Claim in process
05	Claim processing impossible

### 11.3. Registers map

*Map of register groups*  
*Table 19*

Address range	Values type	Description
4000 – 4615	16 bits	registers containing configuration devices, registers for reading and writing
5000 – 5455	16 bits	registers only for reading contain statistical and data parameters of a device
8000 – 13000	16 bits	registers only for reading contain values read out from connected devices, values placed are from 1 channel to 100 channels according to the example below

#### Example.

Fig. 79. shows example channel configuration.

Channel number	Name of the first value	Channel mode	Device address	Base register address	Register size	Registers type
1		Full	1	7523	16b	char
2		Full	1	7000	16b	ulong
3		Full	2	6000	32b	float1234
4		Full	5	4000	32b	long
5		Full	7	5000	16b	float4321
6		Full	8	5500	16b	uchar
7		Off	-	-	-	-

Fig. 79: Example channel configuration

According to this configuration, the values are placed in registers 8000-13000 as shown in table 20.

Table 20

Channel number	Base register address	Registers type	Value number	Register address	Notice
1	7523	char	1	8000	
			2	8001	
			3	8002	
			4	8003	
2	7000	ulong	1	8004	
			2	8006	
			3	8008	
			4	8010	
3	6000	float1234	1	8012	In registers 8000 float1234 takes the form float4321
			2	8014	
			3	8016	
			4	8018	
4	4000	long	1	8020	
			2	8022	
			3	8024	
			4	8026	
5	5000	float4321	1	8028	
			2	8030	
			3	8032	
			4	8034	
6	5500	uchar	1	8036	
			2	8037	
			3	8038	
			4	8039	

In data logger, data is placed in 16-bit registers. The list of registers is presented in the table 19 (registers for reading and writing from address 4000 to 4003) and in the table 20 (registers for writing and reading from address 4004 to 4615). In tables the symbol (\*) stands for a default parameter.

Map of registers for reading and writing form 4000 up to 4003  
Table 21

Register address	Description	
4000	Device ID	Value that can be recorded into a register is a statute value
4001	Status 1	Value that can be recorded in a register is 0
4002	Status 2	
4003	Status 3	

Description of register Status 1.

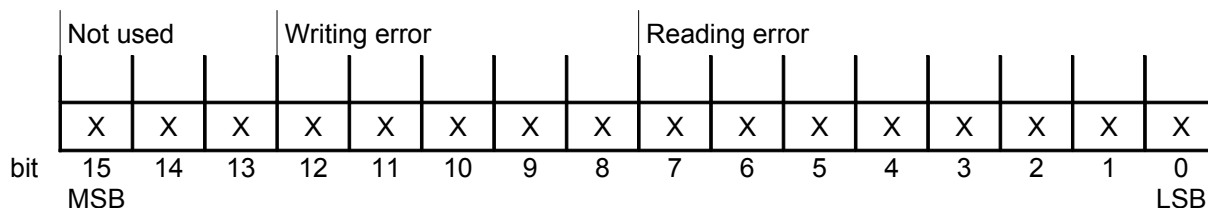

**Bit 15 -13 Not used**

Stan 0

**Bit 12 File log writing error**

Stan 0 - correct writing

Stan 1 - error writing

**Bit 11 Error writing channel configuration**

Stan 0 - correct writing

Stan 1 - error writing

**Bit 10 Error writing interface configuration**

Stan 0 - correct writing

Stan 1 - error writing

**Bit 9 Not used**

Stan 0

**Bit 8 Error writing alarm configuration**

Stan 0 - correct writing

Stan 1 - error writing

**Bit 7 Error creating log file**

Stan 0 - correct creation

Stan 1 - error creation

**Bit 6 Error reading user data**

Stan 0 - correct reading

Stan 1 - reading error

**Bit 5 Error reading channel configuration**

Stan 0 - correct reading

Stan 1 - reading error

**Bit 4 Error reading default parameters**

Stan 0 - correct reading

Stan 1 - reading error

**Bit 3 Error reading interface parameters**

Stan 0 - correct reading

Stan 1 - reading error

**Bit 2 Error initializing values of Modbus registers**

Stan 0 - initialization correct

Stan 1 - initialization error

**Bit 1 Not used**

Stan 0

**Bit 0 Error alarm reading**

Stan 0 - correct reading

Stan 1 - reading error

## Description of register Status 2.

	Not used											Archive																		
bit	X	X	X	X	X	X	X	X	X	X	X	X	X	X	X															
	15	14	13	12	11	10	9	8	7	6	5	4	3	2	1	0														
	MSB															LSB														

**Bit 15 -13 Not used**

Stan 0

**Bit 2 Archive file error**

Stan 0 - archive file correct

Stan 1 - file error

**Bit 1 Archive overloaded**

Stan 0 - archive overloaded

Stan 1 - lack of overload

**Bit 0 Archiving stop**

Stan 0 - archiving in process

Stan 1 - archiving stop

## Description of register Status 3.

	Not used											Inputs		Alarms																
bit	X	X	X	X	X	X	X	X	X	X	X	X	X	X	X															
	15	14	13	12	11	10	9	8	7	6	5	4	3	2	1	0														
	MSB															LSB														

**Bit 15 - 3 Not used**

Stan 0

**Bit 3 Input 2 turned on**

Stan 0 - input 2 turned off

Stan 1 - input 2 turned on

**Bit 2 Input 1 turned on**

Stan 0 - input 1 turned off

Stan 1 - input 1 turned on

**Bit 1 Alarm 2 turned on**

Stan 0 -alarm 2 turned off

Stan 1 - alarm 2 turned on

**Bit 0 Alarm 1 turned on**

Stan 0 - alarm 1 turned off

Stan 1 - alarm 1 turned on



Register map for writing and reading from address 4004 to 4615

Table

22

Register address	Range	Description
4004	112	Function activating code
4005	0...8	Functions: 0- lack of function 1- device reset 2- set default interface parameters 3- set default alarm parameters 4- set all parameters as default 5- save the whole configuration in FLASH memory 6- delete all Modbus Master settings 7- delete all Modbus master settings and save in FLASH memory 8- delete all archive files
<b>RS-485 interface and MODBUS SLAVE/MASTER configuration</b>		
4006	1*...254	Device address
4007	0...8	RS-485 SLAVE interface transmission speed 0- 1200 bit/s 1- 2400 bit/s 2- 4800 bit/s 3*- 9600 bit/s 4- 19200 bit/s 5- 38400 bit/s 6- 57600 bit/s 7- 115200 bit/s 8- speed in accordance with register 4008
4008	1200...115200	Transmission speed
4009	0...3	RS-485 SLAVE interface transmission mode 0- RTU 8N2 1- RTU 8E1 2- RTU 8O1 3*- RTU 8N1
4010	0...8	RS-485 MASTER interface transmission speed 0- 1200 bit/s 1- 2400 bit/s 2- 4800 bit/s 3*- 9600 bit/s 4- 19200 bit/s 5- 38400 bit/s 6- 57600 bit/s 7- 15200 bit/s 8- speed in accordance with register 4011
4011	1200...115200	Transmission speed
4012	0...3	RS-485 MASTER interface transmission mode 0- RTU 8N2 1- RTU 8E1 2- RTU 8O1 3*- RTU 8N1
4013 - 4015		Booked
<b>Ethernet interface configuration</b>		
4016	0...255	MAC address (1)
4017	0...255	MAC address (2)
4018	0...255	MAC address (3)
4019	0...255	IP address (1)
4020	0...255	IP address (2)

Register address	Range	Description
4021	0...255	Subnet mask (1)
4022	0...255	Subnet mask (2)
4023	0...255	Default gateway (1)
4024	0...255	Default gateway (2)
4025	0..1	DHCP (On/Off) 0- DHCP turned off 1- DHCP turned on
4026	0...2	Transmission speed 0- auto 1- 10Mbit 2- 100Mbit
4027 - 4028		Booked
4029	80*...65535	Web server port number
4030	10...65535	Port number of web device searching module
4031	20...65535	FTP command server port number
4032	20...65535	FTP data server port number
4033	0...65535	TELNET server port number
4034	0...65535	SMTP server port number
4035 - 4040		Booked
4041	0...65535	Device name (1)- two ASCII characters
4042	0...65535	Device name (2)- two ASCII characters
4043	0...65535	Device name (3)- two ASCII characters
4044	0...65535	Device name (4)- two ASCII characters
4045	0...65535	Device description (1)- two ASCII characters
4046	0...65535	Device description (2)- two ASCII characters
4047	0...65535	Device description (3)- two ASCII characters
4048	0...65535	Device description (4)- two ASCII characters
4049	0...65535	Device description (5)- two ASCII characters
4050	0...65535	Device description (6)- two ASCII characters
4051	0...65535	Device description (7)- two ASCII characters
4052	0...65535	Device description (8)- two ASCII characters
4053	0...65535	Device description (9)- two ASCII characters
4054	0...65535	Device description (10)- two ASCII characters
4055 - 4060		Booked
<b>MODBUS SLAVE (Ethernet) configuration</b>		
4061	1...255*	MODBUS TCP SLAVE device address
4062	0...65535	MODBUS TCP (502*) port number
4063	1...4	Number of simultaneous connections with MODBUS TCP (2)*
4064	10s*...600s	Port closing time
4065 - 4067		Booked
<b>Archive configuration</b>		
4068	16000* ... 32000	Number of record in a single archive file
4069	0...5	Archiving mode: 0- archiving off 1- archiving on 2- archiving triggered from alarm 1 3- archiving triggered from alarm 2 4- archiving triggered from input 1 5- archiving triggered from input 2
4070	0..1	Settings acceptance for registers 4006-4069: 0- settings without changes 1- saving settings in RAM memory 2 - saving settings in FLASH memory
4071 - 4094		Booked

Register address	Range	Description
4095	0..1	Settings acceptance for registers 4071-4094 0- settings without changes 1- saving settings in volatile memory 2- saving settings in FLASH memory Entering any of the above values displays the value: 0- not saved 3- saving correct
<b>Time</b>		
4096	0..60	Time- current time- seconds
4097	0...2359	Time- current time in format- hours*100 + minutes
4098	101...1231	Time- current date in format- month*100 + day
4099	2001...2099	Time – current year in format YYYY
4100	0..2	Settings acceptance for registers 4096-4099 0- settings without changes 1- current time readout 2- saving time into device Entering any of the above values displays the value: 0- not saved 3- saving correct
4101 - 4170		Booked
<b>Channels configuration</b>		
4171	0...99	Channel work mode: 0- off 1- monitored 2- archived 3- monitored and archived
4172	0...3	Device address
4173	1...254	Modbus (3*) query function
4174	3, 6, 16	Register base address of Slave device
4175	0...65535	Type/ size of registers: 1- one 16-bit register 2- two 16-bit registers
4176	1,2	Registers type 0- char – 16 bits- character data type (two ASCII characters) 1- unsigned char – 16 bits – character data type (two ASCII characters) 2- short- 16 bits – range of value from 32768 to 32767 3- unsigned short- 16 bits- range of value from 0 to 65535 4- long- 32 bits – range of value from -2147483648 to 214748647 5- unsigned long- 32 bits- range of value from 0 to 4294967295 6- float1234 – 32 bits- float number, the smallest byte on the first position 7- float4321- 32 bits – float number, the largest byte on the first position
4177	0...7	Value name 1 for channel
4178 - 4185	0...65535	Value name 2 for channel
4186 - 4193	0...65535	Value name 3 for channel
4194 - 4201	0...65535	Value name 4 for channel
4202 - 4209	0...65535	Value name 5 for channel
4210 - 4217	0...65535	Value name 6 for channel
4218 - 4225	0...65535	Value name 7 for channel
4226 - 4233	0...65535	Value name 8 for channel
4234 - 4241	0...65535	Value name 9 for channel
4242 - 4249	0...65535	Value name 10 for channel
4250 - 4257	0...65535	Value name 11 for channel
4258 - 4265	0...65535	Value name 12 for channel
4266 - 4273	0...65535	Value name 13 for channel

Register address	Range	Description
4274 - 4281	0...65535	Value name 14 for channel
4282 - 4289	0...65535	Value name 14 for channel
4290 - 4297	0...65535	Value name 15 for channel
4298 - 4305	0...65535	Value name 16 for channel
4306 - 4313	0...65535	Value name 17 for channel
4314 - 4321	0...65535	Value name 18 for channel
4322 - 4329	0...65535	Value name 19 for channel
4330 - 4337	0...65535	Value name 20 for channel
4338 - 4345	0...65535	Value name 21 for channel
4346 - 4353	0...65535	Value name 22 for channel
4354 - 4361	0...65535	Value name 23 for channel
4362 - 4369	0...65535	Value name 24 for channel
4370 - 4377	0...65535	Value name 25 for channel
4378	0...65535	Units for value 1 (example- first 7 units) 0- V 1- mV 2- kV 3- A 4- mA 5- kA 6- % 7- C °
4379	0...65535	Units for value 2 (example- first 7 units) 0- V 1- mV 2- kV 3- A 4- mA 5- kA 6- % 7- C °
4380	0...65535	Units for value 3 (example- first 7 units) 0- V 1- mV 2- kV 3- A 4- mA 5- kA 6- % 7- C °
4381-4402	0...65535	Units for value 4- 25 (example- first 7 units) 0- V 1- mV 2- kV 3- A 4- mA 5- kA 6- % 7- C °
4403 - 4452		Booked
4453	0,1	Switching on mathematical operations value 1 for a channel 0- switching off mathematical operations 1- switching on mathematical operations
4454	0,1	Switching on mathematical operations value 2 for a channel 0- switching off mathematical operations 1- switching on mathematical operations

Register address	Range	Description
4455	0,1	Switching on mathematical operations value 3 for a channel 0- switching off mathematical operations 1- switching on mathematical operations
4456 - 4477	0,1	Switching on mathematical operations value 4-25 for a channel 0- switching off mathematical operations 1- switching on mathematical operations
4478	1...655	Argument for mathematical operations value 1 for channel
4479	1...655	Argument for mathematical operations value 2 for channel
4480	1...655	Argument for mathematical operations value 3 for channel
4481-4502	1...655	Argument for mathematical operations value 4-25 for channel
4503	0...4	Type of mathematical operation value 1 0- mathematical operator + 1- mathematical operator - 2- mathematical operator * 3- mathematical operator / 4- mathematical operator =
4504	0...4	Type of mathematical operation value 2 0- mathematical operator + 1- mathematical operator - 2- mathematical operator * 3- mathematical operator / 4- mathematical operator =
4505	0...4	Type of mathematical operation value 3 0- mathematical operator + 1- mathematical operator - 2- mathematical operator * 3- mathematical operator / 4- mathematical operator =
4506 - 4527	0...4	Type of mathematical operation value 4-25 0- mathematical operator + 1- mathematical operator - 2- mathematical operator * 3- mathematical operator / 4- mathematical operator =
4528	0..1	Channel work mode 0- internal channel 1- external channel
4529	0...100	Channel number for mathematical operations on value 1 for current channel 0- lack of channel 1...100- channel number
4530	0...100	Channel number for mathematical operations on value 2 for current channel 0- lack of channel 1...100- channel number
4531	0...100	Channel number for mathematical operations on value 3 for current channel 0- lack of channel 1...100- channel number
4532 - 4553	0...100	Channel number for mathematical operations on value 4-25 for current channel 0- lack of channel 1...100- channel number
4554	0...25	Value number for mathematical operations on value 1 for current channel 0- lack of value 1...100- value number

Register address	Range	Description
4555	0...25	Value number for mathematical operations on value 2 for current channel 0- lack of value 1...100- value number
4556	0...25	Value number for mathematical operations on value 3 for current channel 0- lack of value 1...100- value number
4557 - 4578	0...25	Value number for mathematical operations on value 4- 25 for current channel 0- lack of value 1...100- value number
4579	0...4	Type of mathematical operations on channels and values on value 1 for current channel: 0- mathematical operator + 1- mathematical operator - 2- mathematical operator * 3- mathematical operator / 4- mathematical operator =
4580	0...4	Type of mathematical operations on channels and values on value 2 for current channel: 0- mathematical operator + 1- mathematical operator - 2- mathematical operator * 3- mathematical operator / 4- mathematical operator =
4581	0...4	Type of mathematical operations on channels and values on value 3 for current channel: 0- mathematical operator + 1- mathematical operator - 2- mathematical operator * 3- mathematical operator / 4- mathematical operator =
4582 - 4603	0...4	Type of mathematical operations on channels and values on value 4-25 for current channel: 0- mathematical operator + 1- mathematical operator - 2- mathematical operator * 3- mathematical operator / 4- mathematical operator =
4604	0...65535	Device polling time
4605	0...65535	Device archiving time
4606	0...65535	Device timeout
4607	0...25	Number of values for a selected channel – informs on a number of configured values for a current channel 0- lack of values 1...25- number of values
4608 - 4612		Booked
4613	0...100	Number of a correctly read channel
4614	0...3	Flag informing on reading/ writing data correctness to channel of a selected number 0- lack of reading 1- correct reading of parameters 2- correct writing of parameters to volatile memory 3- correct writing of parameters to FLASH memory

Register address	Range	Description
4615	0...2	Acceptance of settings for registers 4170-4614 0- settings without changes 1- saving settings to volatile memory 2- saving settings to FLASH memory

The list of registers to reading only which contain information with statistics is presented in the table 21.

Map of registers from address 5000

Table

23

Register address	Range	Description
5000	0...65535	Device identifier- like for register 4000
5001	0...65535	Status 1- like for register 4001
5002	0...65535	Status 2- like for register 4002
5003	0...65535	Status 3- like for register 4003
5004	0...60	Current time - seconds
5005	0...60	Current time- minutes
5006	0...23	Current time- hour
5007	0...31	Current time- day
5008	0...12	Current time - month
5009	0...65535	Current time - year
5010	0...7	Current time – day of the week
5011	0...60	Current time of device take-off- seconds
5012	0...60	Current time of device take-off- minutes
5013	0...23	Current time of device take-off- hours
5014	0...31	Current time of device take-off- day
5015	0...12	Current time of device take-off- month
5016	0...65535	Current time of device take-off- year
5017	0...7	Current time of device take-off- day of the week
5018	0...65535	Current time of device take-off- calculated in seconds (older part)
5019	0...65535	Current time of device take-off- calculated in seconds (younger part)
5020	0...65535	Amount of data received on USB port (older part)
5021	0...65535	Amount of data received on USB port (younger part)
5022	0...65535	Amount of data sent on USB port (older part)
5023	0...65535	Amount of data sent on USB port (younger part)
5024	0...65535	Amount of data received on port RS-485/232 Slave (older part)
5025	0...65535	Amount of data received on port RS-485/232 Slave (younger part)
5026	0...65535	Amount of data sent on port RS-485/232 Slave (older part)
5027	0...65535	Amount of data sent on port RS-485/232 Slave (younger part)
5028	0...65535	Amount of data received on LAN port (older part)
5029	0...65535	Amount of data received on LAN port (younger part)
5030	0...65535	Amount of data sent on LAN port (older part)
5031	0...65535	Amount of data sent on LAN port (younger part)
5032	0...65535	Amount of data received on RS-485 Master port (older part)
5033	0...65535	Amount of data received on RS-485 Master port (younger part)
5034	0...65535	Amount of data sent on RS-485 Master port (older part)
5035	0...65535	Amount of data sent on RS-485 Master port (younger part)
5036	0...65535	Number of Modbus Slave RTU queries on USB port (older part)
5037	0...65535	Number of Modbus Slave RTU queries on USB port (younger part)

Register address	Range	Description
5038	0...65535	Number of Modbus Slave RTU queries on RS-485/232 port (older part)
5039	0...65535	Number of Modbus Slave RTU queries on RS-485/232 port (younger part)
5040	0...65535	Number of Modbus Slave RTU queries on LAN port (older part)
5041	0...65535	Number of Modbus Slave RTU queries on LAN port (younger part)
5042	0...65535	Number of Modbus Slave RTU incorrect queries on USB port (older part)
5043	0...65535	Number of Modbus Slave RTU incorrect queries on USB port (younger part)
5044	0...65535	Number of Modbus Slave RTU incorrect queries on RS-485/232 port (older part)
5045	0...65535	Number of Modbus Slave RTU incorrect queries on RS-485/232 port (younger part)
5046	0...65535	Number of Modbus TCP incorrect queries on LAN port (older part)
5047	0...65535	Number of Modbus TCP incorrect queries on LAN port (younger part)
5048	0...65535	Number of Modbus Master queries on RS-485 port (older part)
5049	0...65535	Number of Modbus Master queries on RS-485 port (younger part)
5050	0...65535	Number of correct Modbus Master responses on RS-486 port (older part)
5051	0...65535	Number of correct Modbus Master responses on RS-486 port (younger part)
5052	0...65535	Number of incorrect Modbus Master responses on RS-486 port (older part)
5053	0...65535	Number of incorrect Modbus Master responses on RS-486 port (younger part)
5054	0...65535	Number of incorrect responses- timeout- Modbus Master on RS-485 port (older part)
5055	0...65535	Number of incorrect responses- timeout- Modbus Master on RS-485 port (younger part)
5056	0...65535	Total capacity (free and occupied) of FLASH memory (older part)
5057	0...65535	Total capacity (free and occupied) of FLASH memory (younger part)
5058	0...65535	Free space in FLASH memory (older part)
5059	0...65535	Free space in FLASH memory (younger part)
5060	0...65535	Number of all TCP ports
5061	0...65535	Number of all UDP ports
5062	0...65535	Number of all TCP open ports
5063	0...65535	Number of all UDP open ports
5064	0...65535	IP address of connected device No. 1 (older part)
5065	0...65535	IP address of connected device No. 1 (younger part)
5066	0...65535	IP address of connected device No. 2 (older part)
5067	0...65535	IP address of connected device No. 2 (younger part)
5068	0...65535	IP address of connected device No. 3 (older part)
5069	0...65535	IP address of connected device No. 3 (younger part)
5070	0...65535	IP address of connected device No. 4 (older part)
5071	0...65535	IP address of connected device No. 4 (younger part)
5072	0...65535	IP address of connected device No. 5 (older part)
5073	0...65535	IP address of connected device No. 5 (younger part)
5074	0...65535	IP address of connected device No. 6 (older part)
5075	0...65535	IP address of connected device No. 6 (younger part)



Register address	Range	Description
5076	0...65535	IP address of connected device No. 7 (older part)
5077	0...65535	IP address of connected device No. 7 (younger part)
5078	0...65535	IP address of connected device No. 8 (older part)
5079	0...65535	IP address of connected device No. 8 (younger part)
5080	0...65535	IP address of connected device No. 9 (older part)
5081	0...65535	IP address of connected device No. 9 (younger part)
5082	0...65535	IP address of connected device No. 10 (older part)
5083	0...65535	IP address of connected device No. 10 (younger part)
5084	0...65535	Number of local port for device No. 1
5085	0...65535	Number of local port for device No. 2
5086	0...65535	Number of local port for device No. 3
5087	0...65535	Number of local port for device No. 4
5088	0...65535	Number of local port for device No. 5
5089	0...65535	Number of local port for device No. 6
5090	0...65535	Number of local port for device No. 7
5091	0...65535	Number of local port for device No. 8
5092	0...65535	Number of local port for device No. 9
5093	0...65535	Number of local port for device No. 10
5094	0...65535	Number of remotely-controlled port for device No. 1
5095	0...65535	Number of remotely-controlled port for device No. 2
5096	0...65535	Number of remotely-controlled port for device No. 3
5097	0...65535	Number of remotely-controlled port for device No. 4
5098	0...65535	Number of remotely-controlled port for device No. 5
5099	0...65535	Number of remotely-controlled port for device No. 6
5100	0...65535	Number of remotely-controlled port for device No. 7
5101	0...65535	Number of remotely-controlled port for device No. 8
5102	0...65535	Number of remotely-controlled port for device No. 9
5103	0...65535	Number of remotely-controlled port for device No. 10
5104	0...65535	Number of rejected packets in IP layer (older part)
5105	0...65535	Number of rejected packets in IP layer (younger part)
5106	0...65535	Number of received packets in IP layer (older part)
5107	0...65535	Number of received packets in IP layer (younger part)
5108	0...65535	Number of sent packets in IP layer (older part)
5109	0...65535	Number of sent packets in IP layer (younger part)
5110	0...65535	Number of rejected packets due to incorrect IP version or wrong heading length (older part)
5111	0...65535	Number of rejected packets due to incorrect IP version or wrong heading length (younger part)
5112	0...65535	Number of rejected packets due to incorrect length of IP address (older part)
5113	0...65535	Number of rejected packets due to incorrect length of IP address (younger part)
5114	0...65535	Number of rejected packets due to incorrect length of IP address (older part)
5115	0...65535	Number of rejected packets due to incorrect length of IP address (younger part)
5116	0...65535	Number of rejected packets because they were the part of IP address (older part)
5117	0...65535	Number of rejected packets because they were the part of IP address (younger part)
5118	0...65535	Number of rejected packets due to IP checksum error (older part)
5119	0...65535	Number of rejected packets due to IP checksum error (younger part)

Register address	Range	Description
5120	0...65535	Number of rejected packets because they were not ICMP, UDP or TCP (older part)
5121	0...65535	Number of rejected packets because they were not ICMP, UDP or TCP (older part)
5122	0...65535	Number of rejected ICMP packets (older part)
5123	0...65535	Number of rejected ICMP packets (younger part)
5124	0...65535	Number of received ICMP packets (older part)
5125	0...65535	Number of received ICMP packets (younger part)
5126	0...65535	Number of sent ICMP packets (older part)
5127	0...65535	Number of sent ICMP packets (younger part)
5128	0...65535	Number of ICMP packets with wrong type (older part)
5129	0...65535	Number of ICMP packets with wrong type (younger part)
5130	0...65535	Number of rejected TCP segments (older part)
5131	0...65535	Number of rejected TCP segments (younger part)
5132	0...65535	Number of received TCP segments (older part)
5133	0...65535	Number of received TCP segments (younger part)
5134	0...65535	Number of sent TCP segments (older part)
5135	0...65535	Number of sent TCP segments (younger part)
5136	0...65535	Number of TCP segments with incorrect checksum (older part)
5137	0...65535	Number of TCP segments with incorrect checksum (younger part)
5138	0...65535	Number of TCP segments with incorrect ACK number (older part)
5139	0...65535	Number of TCP segments with incorrect ACK number (younger part)
5140	0...65535	Number of received RTS of TCP segments (older part)
5141	0...65535	Number of received RTS of TCP segments (younger part)
5142	0...65535	Number of retransmitted TCP segments (older part)
5143	0...65535	Number of retransmitted TCP segments (younger part)
5144	0...65535	Number of rejected SYN's due to small number of available connections (older part)
5145	0...65535	Number of rejected SYN's due to small number of available connections (younger part)
5146	0...65535	Number of SYN's for a closed port causing reset (older part)
5147	0...65535	Number of SYN's for a closed port causing reset (younger part)
5148	0...65535	Number of rejected UDP segments (older part)
5149	0...65535	Number of rejected UDP segments (younger part)
5150	0...65535	Number of read UDP segments (older part)
5151	0...65535	Number of read UDP segments (younger part)
5152	0...65535	Number of sent UDP segments (older part)
5153	0...65535	Number of sent UDP segments (younger part)
5154	0...65535	Number of UDP segments with wrong checksum (older part)
5155	0...65535	Number of UDP segments with wrong checksum (younger part)
5156	0,1,2	Modbus Master query status for channel 1: 0 - lack of reading 1 - correct reading 2 - wrong reading
5157	0,1,2	Modbus Master query status for channel 2: 0 - lack of reading 1 - correct reading 2 - wrong reading
5158	0,1,2	Modbus Master query status for channel 3: 0 - lack of reading 1 - correct reading 2 - wrong reading

Register address	Range	Description
5159 - 5251	0,1,2	Modbus Master query status for channel 4-100: 0 - lack of reading 1 - correct reading 2 - wrong reading
5252	0...65535	Timeout value for channel 1
5253	0...65535	Timeout value for channel 2
5254	0...65535	Timeout value for channel 3
5255 - 5351	0...65535	Timeout value for channel 4 -100
5352	0...65535	Real timeout value for channel 1
5353	0...65535	Real timeout value for channel 2
5354	0...65535	Real timeout value for channel 3
5355 - 5451	0...65535	Real timeout value for channel 4 -100

## 12. Technical data

### Communication interfaces

Table 24

Interface	Port 1: RS – 485, RS -232	Port 2: RS – 485	USB	Ethernet 10/100Base-T
Function	Communication with PC and HMI panels	Communication Slave devices	Configuration of the device	Communication and configuration of the device
Baud rate	1200, 2400, 4800, 9600, 19200, 38400, 57600, 115200 bit/s		115200 bit/s	10, 100 Mbit/s
Information unit	1 start bit, 7 or 8 data bits 1 odd/even parity 1 or 2 stop bits		1 start bit, 8 data bits, 1 even parity bit, 1 stop bit	TCP/UDP
Transmission protocol	Modbus RTU			HTTP, FTP, ICMP, DHCP, ARP, Modbus TCP
Comments	Max. cable length depends on the baud rate		Max. cable length up to 2 m	Max. cable length: up to 100 m

### External features

Weight	<0,25kg
Dimensions	45X120X100mm
Degree of protection (according to EN 60529)	From the cover: IP40 From the terminal site: IP20
Fixing	Rail mounting 35mm

### Rated operating conditions

Supply voltage	20... <u>24</u> ...40 V a.c. ,20... <u>24</u> ...60 V d.c.	Power consumption: <4VA 40... <u>50/60</u> ...440 Hz
	10...16 V a.c. ,10...20 V d.c.	
	85... <u>230</u> ...253 V a.c. ,90...300 V d.c.	
Ambient temperature	Work: 0... <u>23</u> ...55°C	Storage: -20...70 °C

Relative humidity	<95%	Not permissible condensation
Position of work	any	
External magnetic field	<400 A/m	

### Safety and compatibility requirements

Electromagnetic compatibility	Immunity to interference	According to EN 61000-6 -2
	Emission of interference	According to EN 61000-6-4
Safety requirements	Installation category III	According to EN 61010-1
	Degree of pollution 2	
Maximum voltage to earth	For the circuit: 300V	
	For other circuits: 50V	

## 13. Ordering codes

The way of coding was presented in table 23.

Ordering codes

Table 25

		<b>SM61IoT –</b>				
		X	X	XX	X	X
<b>Supply</b>	85...253 V a.c. 90...300 V d.c.	1				
	20...40 V a.c. 20...60 V d.c.	2				
	10...16 V a.c. 10...20 V d.c.	3				
<b>Input/Output</b>	2 relays outputs		1			
	2 binary inputs		2			
<b>Version</b>	standard			0		
	special <sup>1)</sup>			XX		
<b>Language</b>	Polish				P	
	English				E	
	other <sup>1)</sup>				X	
<b>Acceptance tests</b>	without extra requirements					0
	with an extra Quality Inspection Certificate					1
	according to customer's request					X

---

<sup>1)</sup> only after agreeing with the manufacturer

**Coding example:**

**The code SM61IoT – 1 2 00 E 1** means manufacturing a device that has:

- supply 85...253V a.c.,
- two binary inputs,
- standard option,
- English language version,
- with quality inspection certificate.



**LUMEL S.A.**

ul. Sulechowska 1, 65-022 Zielona Góra, POLAND

tel.: +48 68 45 75 100, fax +48 68 45 75 508

[www.lumel.com.pl](http://www.lumel.com.pl)

**Export department:**

tel.: (+48 68) 45 75 139, 45 75 233, 45 75 321, 45 75 386

fax.: (+48 68) 32 54 091

e-mail: [export@lumel.com.pl](mailto:export@lumel.com.pl)