

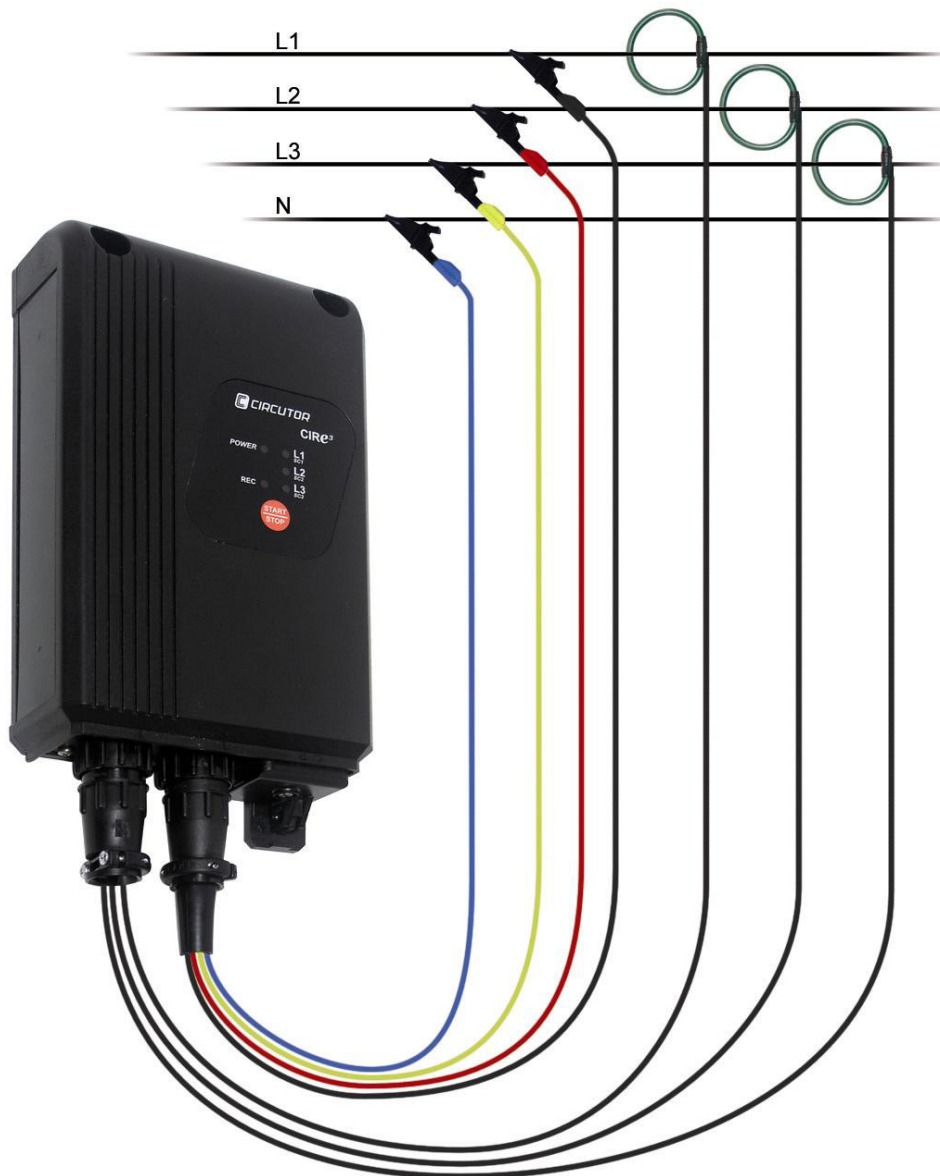

AUDITOR

CIR-*e*³





USER'S MANUAL

(M98225801-03-12A)



WARNINGS / SYMBOLS

<p>DANGER</p> 	<p>Death, serious injury, or fire hazard could result from improper connection of this instrument. Read and understand this manual before connecting this instrument. Follow all installation and operating instructions while using this instrument.</p> <p>Installation, operation, and maintenance of this instrument must be performed by qualified personnel only. The National Electrical Code defines a qualified person as “one who has the skills and knowledge related to the construction and operation of the electrical equipment and installations, and who has received safety training on the hazards involved.”</p>
--	--

<p>WARNING</p> 	<p>Consult the instruction manual before using the equipment.</p> <p>In this manual, if the instructions preceded by this symbol are not met or done correctly, can cause personal injury or equipment damage and / or facilities.</p>
--	---





ADVERTENCIAS / SÍMBOLOS

<p>PELIGRO</p> 	<p>Una conexión incorrecta del equipo puede producir la muerte, lesiones graves y riesgo de incendio. Lea y entienda el manual antes de conectar el equipo. Observe todas las instrucciones de instalación y operación durante el uso de este instrumento.</p> <p>La instalación, operación y mantenimiento de este instrumento debe ser efectuado por personal cualificado solamente. El Código Eléctrico Nacional define a una persona cualificada como "una que esté familiarizada con la construcción y operación del equipo y con los riesgos involucrados".</p>
---	---

<p>ATENCIÓN</p> 	<p>Consultar el manual de instrucciones antes de utilizar el equipo</p> <p>En el presente manual, si las instrucciones precedidas por este símbolo no se respetan o realizan correctamente, pueden ocasionar daños personales o dañar el equipo y /o las instalaciones.</p>
--	--

F AVERTISSEMENT / SYMBOLES

<p>DANGER</p> 	<p>Un branchement incorrect de l'appareil peut entraîner la mort ou des lésions graves et peut provoquer un incendie. Avant de brancher votre appareil, lisez attentivement le manuel et assurez-vous de bien avoir compris toutes les explications données. Respectez toutes les instructions concernant le mode d'installation de l'appareil et son fonctionnement.</p> <p>L'installation, le fonctionnement et la maintenance de cet appareil doivent être réalisés uniquement par du personnel qualifié. Le code électrique national définit en tant que personne qualifiée « toute personne connaissant le montage et le fonctionnement de l'appareil ainsi que les risques que ceux-ci comportent »</p>
--	---

<p>ATTENTION</p> 	<p>Consulter le manuel d'instructions avant d'utiliser l'appareil</p> <p>Si les instructions suivantes, précédées dans le manuel d'un symbole, ne sont pas respectées ou sont réalisées incorrectement, elles pourront provoquer des dommages personnels ou abîmer l'appareil et/ou les installations.</p>
--	---

D WARNHINWEISE / SYMBOLE

<p>GEFAHR</p> 	<p>Durch einen nicht sachgemäßen Anschluss der Anlage können Tod, schwere Verletzungen und Brandrisiko hervorgerufen werden. Bevor Sie die Anlage anschließen, lesen Sie bitte das Handbuch durch und machen Sie sich dessen Inhalt klar. Beachten Sie bei Einsatz dieses Instrumentes sämtliche Installations- und Betriebshinweise.</p> <p>Installation, Betrieb und Wartung dieses Instrumentes müssen ausschließlich von entsprechend qualifiziertem Personal vorgenommen werden. Von dem nationalen Elektrocode wird eine qualifizierte Person als jemand definiert, "der mit der Konstruktion und dem Betrieb einer Anlage und der damit verbundenen Risiken vertraut ist".</p>
--	---

<p>ACHTUNG</p> 	<p>Vor Inbetriebnahme der Anlage ist das Handbuch zu lesen.</p> <p>Werden die in dem vorliegenden Handbuch mit diesem Symbol versehenen Hinweise nicht beachtet oder falsch verstanden, können Personenschäden und Schäden an der Anlage und/oder den Installationen verursacht werden.</p>
---	--

P ADVERTÊNCIAS / SÍMBOLOS

<p>PERIGO</p> 	<p>Uma ligação incorrecta do equipamento pode provocar a morte, lesões graves e risco de incêndio. Leia e compreenda o manual antes de ligar o equipamento. Observe todas as instruções de instalação e operação durante o uso deste aparelho.</p> <p>A instalação, operação e manutenção deste aparelho devem ser levadas a cabo exclusivamente por pessoal qualificado. O Código Eléctrico Nacional define uma pessoa qualificada como "uma pessoa que se encontre familiarizada com a construção e operação do equipamento assim como com os riscos inerentes".</p>
--	--

<p>ATENÇÃO</p> 	<p>Consultar o manual de instruções antes de utilizar o equipamento</p> <p>No presente manual, se as instruções que precedem este símbolo não forem respeitadas ou realizadas de forma correcta, podem ocorrer ferimentos pessoais ou danos no equipamento e/ou nas instalações.</p>
--	---

I AVVERTENZE / SIMBOLI

<p>PERICOLO</p> 	<p>Un collegamento errato del dispositivo può provocare morte, lesioni gravi nonché rischio di incendio. Prima di collegare il dispositivo leggere attentamente il manuale. Osservare tutte le istruzioni relative all'installazione e all'operatività durante l'uso di questo strumento.</p> <p>L'installazione, operatività e manutenzione di questo strumento devono essere realizzate solamente da personale qualificato. Il Codice Elettrico Nazionale definisce una persona qualificata come "colui che ha familiarità con la costruzione e operatività del dispositivo e con i rischi che ne possano derivare".</p>
--	--

<p>ATTENZIONE</p> 	<p>Consultare il manuale di istruzioni prima di utilizzare il dispositivo</p> <p>Qualora le istruzioni riportate nel presente manuale precedute da questo simbolo non vengano osservate o realizzate correttamente, possono provocare danni personali o danneggiare il dispositivo e/o gli impianti.</p>
--	---

1.-	LIMITATION OF LIABILITY.....	8
2.-	VERIFICATION UPON RECEPTION.....	8
3.-	SAFETY PRECAUTIONS.....	8
4.-	DESCRIPTION OF THE UNIT.....	9
4.1.-	ELECTRICAL FEATURES.....	11
4.1.1.-	Maximum/Minimum current, depending on the clamp and scale selected.....	11
4.2.-	MECHANICAL FEATURES.....	12
4.3.-	ELECTRICAL PARAMETERS.....	13
4.3.1.-	Three-phase circuit parameters.....	13
4.3.2.-	Single-phase circuit parameters.....	13
5.-	BASIC FEATURES.....	14
5.1.-	ENVIRONMENTAL AND OTHER FEATURES.....	15
6.-	INSTALLATION AND COMMISSIONING.....	15
6.1.-	CONNECTING TO AND REGISTERING IN CIR-E ³ WEB.....	16
6.1.1.-	Accessing cir-e3 web.....	16
6.1.2.-	Registration.....	17
6.2.-	DOWNLOADING THE XCG IDENTIFICATION FILE:.....	19
6.2.1.-	Personal user information on the web.....	20
6.2.1.1.-	<i>User information modify</i>	20
6.2.1.2.-	<i>Password modify</i>	21
6.2.1.3.-	<i>Generate XCG file</i>	21
6.2.1.4.-	<i>Downloads</i>	21
6.3.-	CONFIGURING CIR-E ³	22
6.3.1.-	Generating the setup file.....	22
6.3.2.-	Menu options.....	23
6.3.2.1.-	<i>Configure</i>	23
6.3.2.2.-	<i>Connect</i>	26
6.3.2.3.-	<i>Exit</i>	26
6.3.2.4.-	<i>Send to Web</i>	26
6.4.-	INSERT SD CARD.....	26
6.5.-	START-UP SEQUENCE.....	27
6.5.1.-	Power and connect the unit.....	27
6.5.1.1.-	<i>Single-phase connection diagram</i>	29
6.5.1.2.-	<i>Three-phase connection diagram (3 wires)</i>	30
6.5.1.3.-	<i>Three-phase connection diagram (4 wires)</i>	30
6.5.2.-	Selecting the scale for flexible clamps.....	31
6.5.3.-	Verification of connections.....	32
6.5.3.1.-	<i>Faulty connection</i>	33
6.6.-	START/STOP BUTTON.....	35

6.7.- SAFE EXTRACTION OF THE SD MEMORY CARD	35
6.8.- INSERT SD MEMORY CARD IN A PC	35
6.9.- TRANSFERRING DATA TO CIREWEB	36
6.10.- ANALYSIS AND DISPLAY OF DATA	38
6.10.1.- List of Reports.....	39
6.10.2.- List of Devices	39
6.10.3.- Parameter selection menu	39
6.10.3.1.- <i>Standard</i> :.....	40
6.10.3.2.- <i>Harmonics</i> :	41
6.10.4.- Report information	42
6.10.5.- Report graphs.....	43
7.- FAQS	46
8.- CIR-E3 INSTALLATION VIDEO.....	47
9.- REGULATIONS	48
10.- TECHNICAL SERVICE.....	48
11.- FEATURES OF CIR-E ³ CLAMPS	49
11.1.- E-FLEX 54	49
11.2.- CP-5 Y CP-100.....	51
12.- BATTERY CHANGE	52
13.- SETTING THE TIME OF THE ANALYZER.....	52
14.- CE CERTIFICATE	56

1.-LIMITATION OF LIABILITY

CIRCUTOR, SA reserves the right to modify the device or the specifications of the equipment, described in this instruction manual, without prior notice. **CIRCUTOR, SA** recommends obtaining the latest version of the unit's specifications and applications of the device from: <http://cir-e3.circutor.com>

CIRCUTOR, SA informs that the user can view a video explaining the way of installing equipment on the website www.circutor.com



CIRCUTOR, SA recommends the use of the original cables and accessories supplied with the unit.

2.-VERIFICATION UPON RECEPTION

CIR-e³ has been designed to incorporate the latest technologies and it offers the most advanced performance features in the market for the measurement and recording of the electrical parameters of electrical networks.



Please read this manual carefully before connecting the unit, in order to avoid any incorrect usage that could seriously damage the unit.

Check the following when you receive the unit:

- a) The unit's specifications are the same as you order.
- b) The unit has not been damaged during transport.
- c) Check that the following accessories are included:

- 1 **CIR-e³** Measurement unit
- 1 SD Card with a minimum capacity **1 Gb**.
- 1 Kit of three current measure clamps (depends on model)
- 1 Kit of six power supply and voltage cables (2 m).
- 4 Crocodile clamps.
- 1 RS-232 Communications wire.
- 1 SD Card reader.
- 1 User's Manual

3.-SAFETY PRECAUTIONS.

Please observe the warnings described in this manual. The warnings are marked with the following symbols.



DANGER: Electrical risk warning.



ATTENTION: Special attention message or warning.



DANGER: Do not handle with voltage in aerial connector.

4.-DESCRIPTION OF THE UNIT

The figure shows the description and location of the analyzer's components.

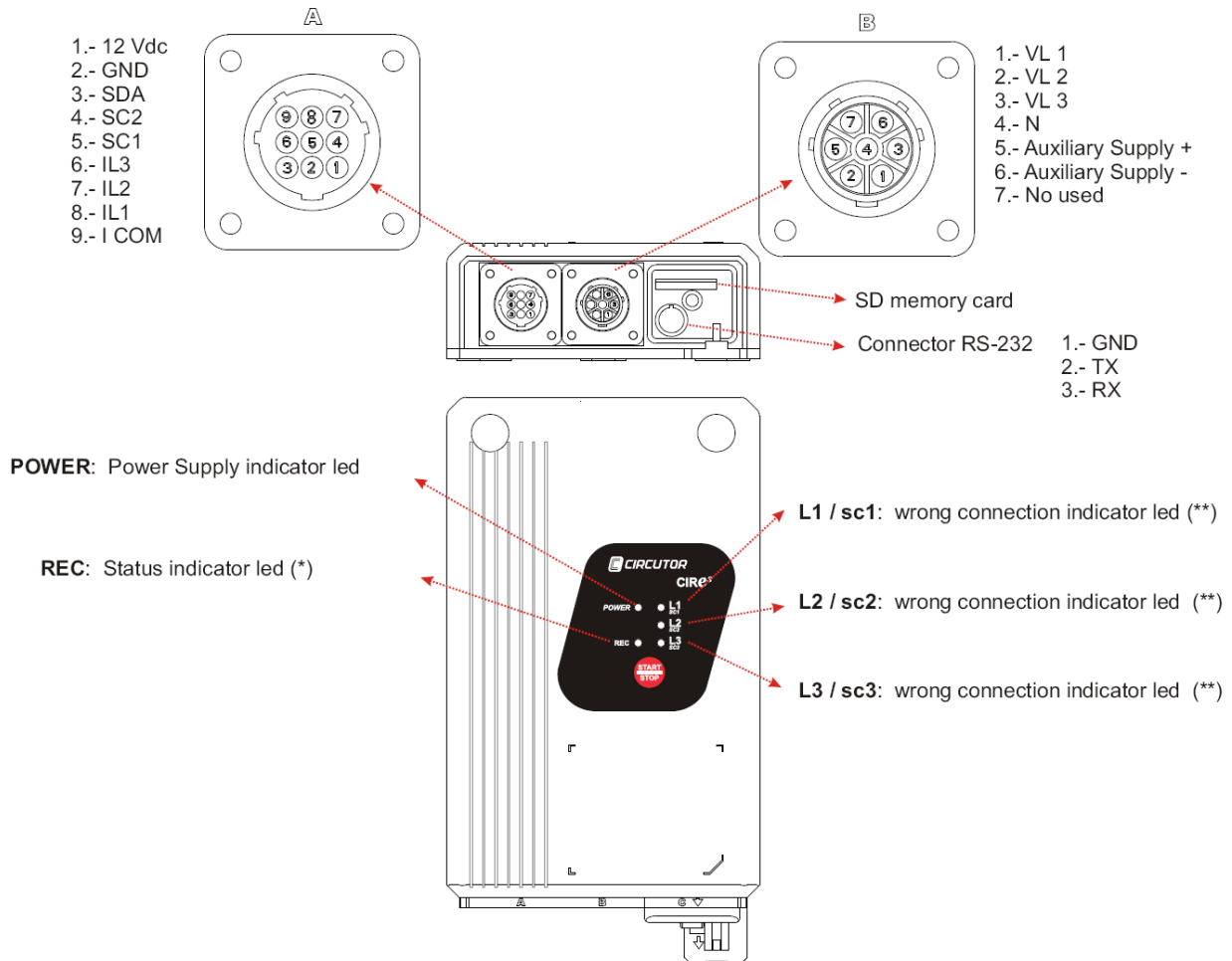

Connector A is used to connect the current sensors. The drawing describes the functionality of each connector.

Connector B is used to connect the voltage references of the unit. Connector B is used to connect the voltage references of each phase (marked with VL1, VL2 and VL3), the neutral reference (marked with N) and two additional pins (5 and 6) used to power the unit, as shown in the figure. Terminals 5 and 6 are used to power the unit independently from the measurement, in order to guarantee a permanent recording flow when powering the analyzer with an uninterruptible power supply system. More information about the unit's measurement and power supply features in section 4.1 *Electrical Features*.

SD card slot is used to insert the removable SD memory card to record the electrical parameters measured by the unit. Read chapter 6.4 *Insert SD card* to see the position of the SD card.

RS-232 connector is reserved to update unit's firmware.

POWER LED is on when the unit is powered. It is off when the unit is not powered.

The START/STOP button has different functions, depending on the analyzer's operation. It is used to select the scale desired for the current sensors or to start or stop the recording of electrical parameters. In this case, to start or stop the recording process, hold the button during **3 seconds**.

(*) The REC LED has three basic modes. When it is off, the unit is not recording information. When it is permanently on, the unit is recording electrical parameters, which are stored in the SD memory card. When the REC LED is flashing, there is an error in the SD memory card. The REC LED can be flashing for the following reasons:

- No memory card inserted in the unit's SD card slot.
- The memory card inserted does not have the correct format or data can not be written. (for example, if the card is write protected or it has a FAT32 format; in that case change the format of the memory card to **FAT16**).

(**) The LEDs corresponding to L1/sc1, L2/sc2 and L3/sc3 can also indicate different situations, depending on the unit's status and during the start-up procedure.

- Should the **CIR-e³** unit detects flexible clamps connected during start-up, the LEDs can be used to select the scale desired for the current sensors. In this case, reference will be provided with the legend of the LED shown on the scale (*sc1*, *sc2* or *sc3*).
- When you have selected the scale (if needed) or the unit detects clamps with a single scale automatically (so that the scale selection process is not required), the LEDs will start flashing to indicate that there is an incorrect connection. The phase LEDs can flashing for reasons:
 - Incorrect connection of the voltage references. Flashing indicates that there is an incorrect phase sequence (L1, L2 and L3).
 - The unit detects power values with a negative sign (as in the case of generated power).
 - The installation's power factor is under 0.5, i.e., the angle between the voltage and current corresponding to that phase exceeds 60°. This error indicates that there is a fault in the unit and we recommend going through the connections.



CIR-e³ LED's start flashing to indicate a connection error. The unit has been installed correctly when the LED's are permanently on. Is possible flashing when the angle of $\cos \phi$ is very bad.

4.1.- ELECTRICAL FEATURES

Power supply circuit (connector B, brown and green wires)	
AC voltage	100...400 Vac
DC voltage	70...315 Vdc
Frequency	50 / 60 Hz
Consumption	9 V·A
Measurement circuit	
Voltage	10...400 Vac (p-neutral)
	17...690 Vac (ph-ph)
Current (.../2V)	2,5...100% E.Scale Clamps
Frequency	45...65 Hz
Accuracy	
Voltage	0,5 % of E.S.
Current	1 % of E.S.
Power	2 % of E.S.
Energy	2%
Battery	
Devices (until 2011)	NiMH
Devices from 2012 or later	BR2032



Devices manufactured before 2012 has rechargeable battery.
Devices manufactured after 2012, have BR2032 battery. We recommend replacing it every 5 years.

4.1.1.- MAXIMUM/MINIMUM CURRENT, DEPENDING ON THE CLAMP AND SCALE SELECTED.

Clamp	LED	Scale	Range (2.5...100%)
E-FLEX 54 cm	L1/sc1	200 A	5...200 A
	L2/sc2	2.000 A	50...2.000 A
	L3/sc3	20.000 A	500...20.000 A
Kit CP-5A		5 A	0,05...5 A
Kit CP-100A		100 A	1...100 A

NOTE: We recommend a nominal measurement current of 10% to 100% of the scale base selected when installing the unit but reaching up to 120%. Therefore, you will guarantee that the current sensors are working in their linear zone.

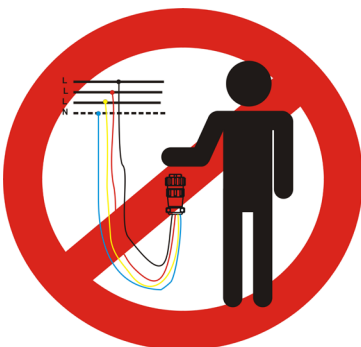

Do not handle the air connector where the terminals are connected to a voltage source. We recommend use personal protective equipment for handling and connecting the device and follow the procedure explained in this manual to avoid personal and equipment injury.



The colours of voltage phases can change according to the colour scheme selected in the device code. The following table lists the references for each phase of the different colours.

PHASE	EUROPEAN	RYBLB
Phase reference	Wire colour	Wire colour
(L 1) PHASE 1	BLACK	RED
(L 2) PHASE 2	RED	YELLOW
(L 3) PHASE 3	YELLOW	BLUE
(N) NEUTRAL	BLUE	BLACK
Auxiliary supply	BROWN	BROWN
Auxiliary supply	GREEN	GREEN

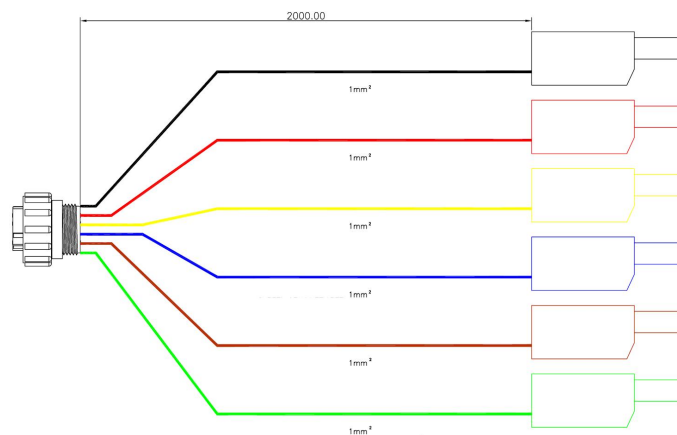

4.2.- MECHANICAL FEATURES.

The **CIR-e³** analyzer has been specially designed for an installation in small spaces. For example, in boxes with double isolation where billing energy meters, single or three-phase models are installed. The external dimensions in mm are as follows:

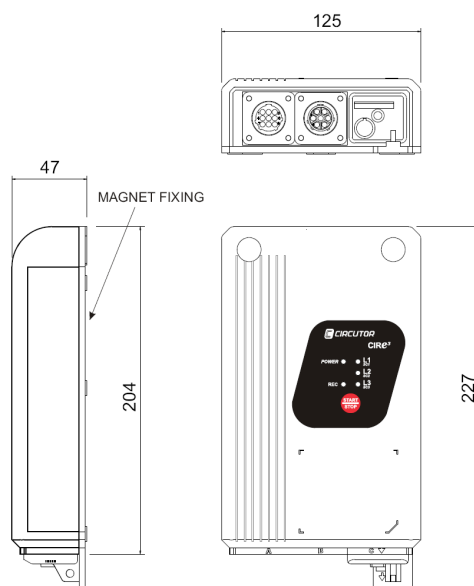

4.3.- ELECTRICAL PARAMETERS

The parameters recorded by **CIR-e³** can not be selected and they are those shown on the following table. The parameters are valid for three and single-phase circuits.

4.3.1.- THREE-PHASE CIRCUIT PARAMETERS

The following table shows the parameters recorded by the unit during the measurements taken in an unbalanced 4-wire three-phase system.

Parameter	Symbol	L1	L2	L3	III	Max Min
Phase-neutral voltage	V_{p-N}	X	X	X		X
Phase-Phase voltage	V_{p-p}	X	X	X		X
Current	A	X	X	X	X	X
Neutral current (calculated)	AN					
Frequency	Hz	X				X
Active Power (consumed)	kW	X	X	X	X	X
Reactive power L (consumed)	kvarL	X	X	X	X	X
Reactive power C (consumed)	kvarC	X	X	X	X	X
Apparent Power (consumed)	kVA	X	X	X	X	X
Power Factor *	PF	X	X	X	X	X
Cosinus *	Cos	X	X	X	X	X
Active Energy (consumed)	kW·h				X	
Reactive Energy L (consumed)	kvar·h L				X	
Reactive Energy C (consumed)	Kvar·h C				X	
Apparent Energy	KVA·h				X	
Maximum Demand Active P (Md)	kW (Md)				X	X
Maximum Demand Apparent Power	KVA (Md)				X	X
Harmonic decomposition V (50°)	Arm V	X	X	X		
Harmonic decomposition A (50°)	Arm A	X	X	X		
THD V	THD V	X	X	X		X
THD I	THD A	X	X	X		X
Fundamental V		X	X	X		
Fundamental I		X	X	X		
Flicker WA	WA	X	X	X		X
Flicker Pst	Pst	X	X	X		

* The default value of angles is 1 when the analyzer doesn't detect any measured.

4.3.2.- SINGLE-PHASE CIRCUIT PARAMETERS

The electrical parameters recorded by **CIR-e³** when the unit is connected to a single-phase circuit correspond to L1; all others are recorded with zero value.

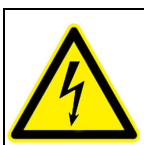

In order to guarantee the unit's safe operation, all persons installing or using the unit must follow the safety measures established in the current low voltage safety regulations, as well as all warnings defined in this instruction manual.



If you use the unit in a way that is not specified by the manufacturer, the protection of the unit may be compromised and the user might be harmed.

5.-BASIC FEATURES

The **CIR-e³** analyzer is a programmable measurement unit that **measures, calculates and records** the main electrical parameters of single and three-phase industrial networks in its memory. We must highlight the following concepts:

Serial number: The serial number of **CIR-e³** is an important parameter, since all files generated by the unit must be identified with that number. The 10-digit serial number is written on the rear features label of **CIR-e³**.

Programming: The unit is programmed with the setup software **CIR-e.exe**. The application is stored in the SD card supplied with the unit. In addition, the card records the electrical parameters that are sent to the Web server.

Display (in Cir-e³ Web): The measurement unit includes the right of use of the associated software that is required to handle the energy data of the **CIR-e³ Web** application. It is located in a web site that is active 24 hours a day, 365 days a year: <http://cir-e3.circutor.com>.

Installation: The analyzer can be installed to analyze balanced (3 wire) or unbalanced (4 wire) single and three-phase networks. The unit must be powered with the auxiliary power supply cables in any of the connection options. The auxiliary power supply wires of the unit are Brown and Green.

Measurements: The analyzer takes 128 samples per cycle of the voltage and current variables in true root mean square (TRMS). With all of the samples taken, the unit calculates the arithmetic mean during the recording period selected by the user. The analyzer also records the maximum and minimum values measured during each period. To take these measurements, the analyzer has four voltage sensor inputs and three current sensor inputs.

Recording: The unit has a 1 Gb external SD memory, FAT16 format, which stores the parameters measured or calculated by the analyzer. We must highlight the following features:

- It stores the parameters instantly (measured for a selected period).
- It stores the maximum and minimum values of the recording period selected.
- The SD memory can be expanded to 2 Gb.

With SD memory of 1Gb the period estimated to register is:

	Register period		Registering time	
	1 minute		1 year and 8 months	
	10 minutes		17 year and 4 months	
	120 minutes		104 year and 4 months	

Current sensors: The analyzer can work with different models of current sensors. One type of sensor has a single measurement scale. Another sensor model is flexible, allowing the configuration of various measurement ranges. The flexible clamps supplied with the CIR-e³ analyzer are of the E-FLEX 54 model and can be used with three different scales. More information about clamps in chapter 11. *Features of E-FLEX and CP clamps.*

5.1.- ENVIRONMENTAL AND OTHER FEATURES

Environmental Work Conditions	
Temperature	10...50 °C
Altitude	2.000 m
Humidity	95% RH non-condensing
Others	
Storage temperature	-10...65 °C
Degree of protection	IP 53
Weight (only CIRe³)	0,677 kg
Weight (with packaging)	0,733 kg

This manual contains information and warnings that must be observed at all times to guarantee the safe operation of the unit and maintain it in perfect working conditions.

When you suspect an operational fault in the unit's protection system (for example, visible damage), disconnect the unit from any voltage or current source and contact a qualified service representative or the after sales service of **CIRCUTOR, SA**.

	<p>Anyone installing or using the equipment must follow the safety measures set forth and all warnings indicated in this instruction manual to guarantee a safe operation.</p>
--	--

6.-INSTALLATION AND COMMISSIONING

	<p>If the battery is discharged when the team loses and records are made with the default date 01/01/2011 00:00 It is recommended to check the time of the device before making a record and, after long period of inactivity, connect the device 12 hours to charge the battery.</p>
---	---

CIR-e³ is a portable analyzer that is easy to install and use. It has been designed to facilitate the work of the companies and/or persons that wish to perform energy audits (study of consumption) and control the main electrical parameters in an installation.

The study of these parameters is the first step to analyze the response of loads and the consumption habits of a company or corporation. Without a doubt, the decisions taken after the study can be focused on a more rational consumption of energy and a decrease in the power demand of the electricity network.

The unit is configured from the PC with the SD card supplied with the unit. After selecting the scale desired for the current sensors (in case of flexible clamps), make sure that all voltage and current connections are correct so that the unit is ready to take measurements and record data.

Operation of CIR-e³ in 10 easy steps

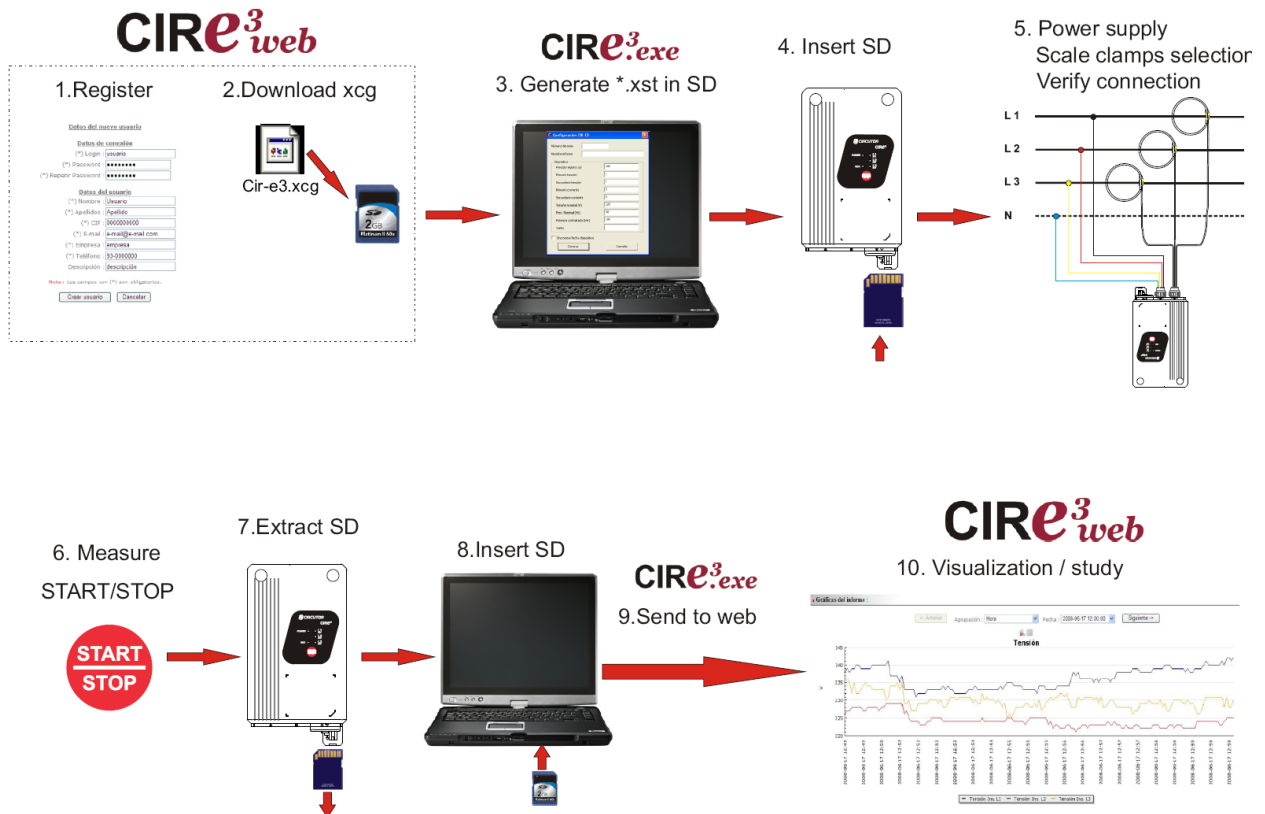

Please follow these steps to configure, install and commission the unit.

6.1.- CONNECTING TO AND REGISTERING IN CIR-E³WEB

CIRCUTOR recommends to the user to register on the web site in order to receive all the information and to have the latest version of manual and firmware.

The web page is a tool used to analyze and export the files recorded by the **CIR-e** analyzer. Web site: <http://cir-e3.circutor.com>. The access and registration procedure is described next.

6.1.1.- ACCESSING CIR-E3 WEB

Open <http://cir-e3.circutor.com> in your browser to access the data handling page of **CIR-eWeb**. The following start screen will be displayed when you open the page in your browser.

Login :

Password :

If you don't remember your password, you must click [here](#)

[Still do not have user?](#)

You must register when accessing the page for the first time in order to access the Web-based application.

To register, click on [Still do not have user?](#) The registration process is explained in section 6.1.2. *Registration*.

The fields *Login* and *Password* are used by users that have already been registered in the system:

<i>Login:</i>	User name
<i>Password:</i>	Access password

After entering the *login* and *password*, click on “Send” to access the Web site.

6.1.2.- REGISTRATION

You must fill in the registration form when accessing **CIR-eWeb** for the first time. Its function is to reserve a space on the web site that you can use to send and handle the data recorded by the **CIR-e** device.

To register, click on [Still do not have user?](#) Click on this link and the application will display the registration form. Fill it in with your information.

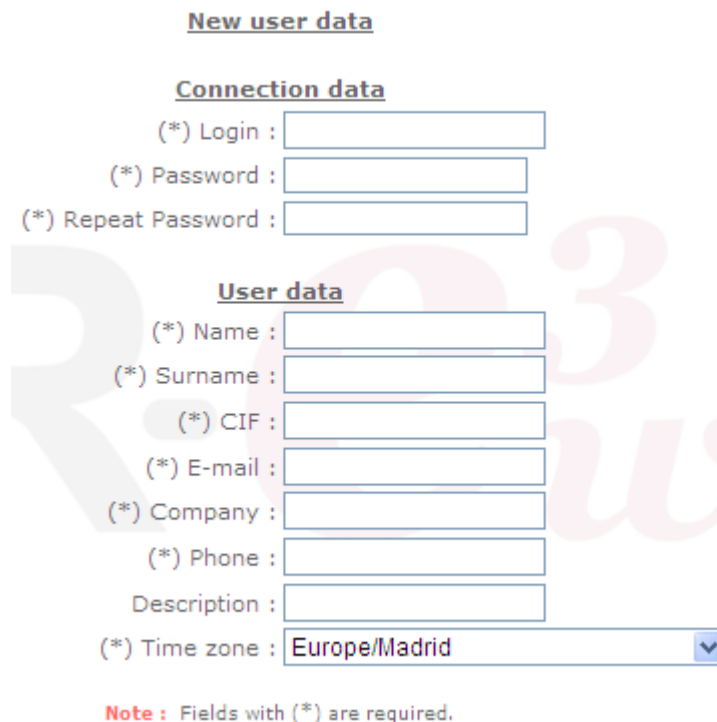

The registration form is titled "New user data" and is divided into two sections: "Connection data" and "User data".

Connection data

- (*) Login :
- (*) Password :
- (*) Repeat Password :

User data

- (*) Name :
- (*) Surname :
- (*) CIF :
- (*) E-mail :
- (*) Company :
- (*) Phone :
- Description :
- (*) Time zone :

Note : Fields with (*) are required.

The following information is requested to register a new user:

<i>Login:</i>	Access name used to register and access future connections to the CIR-eWeb server. You can enter alphanumerical values in this field, although we recommend not using symbols, accents, etc.
<i>Password:</i>	Access password with which the user is registered and which will be used in future connections to the CIR-eWeb server. You can enter alphanumerical values in this field, although we recommend not using symbols, accents, etc.

CIF: Company / Personal Tax Identification code.
E-mail: Contact email address.
Company: Name of the company.
Telephone: Contact phone.
Description: Description of the account (optional).
Time zone: Must be set in this field the time zone where the user will use the device. This field entered by the user is very important since this field is that the application uses to calculate the local time registrations by the analyzer.

The use of **CIRCUTOR's** CIR-e³ Web application is subject to the acceptance of the following Conditions for Use:

1. The user is responsible for any activity carried out with his/her user name and for any information sent through the CIR-e³ Web application.
2. The user is responsible for the use of the CIR-e³ Web application under the legal terms.
3. The user is responsible for sending files that are free from viruses or worms to the CIR-e³ Web application. Should a virus or worm be sent to the CIR-e³ Web application or a fraudulent use of the tool is detected, CIRCUTOR reserves the right to cancel the user's registration.
4. CIRCUTOR, shall not be liable for the incorrect interpretation of the information sent to the display tool or the incorrect recording of said data.
5. CIRCUTOR, shall not be liable for the damages resulting in the loss of information to you or third parties, derived from the data sent to the Web application.
6. The user is responsible for keeping the appropriate original files and backup copies of the records registered by the CIR-e³ analyzer with an STD extension, which will be stored in the original hard drive where they were sent from.
7. CIRCUTOR, shall not be liable for storing the data sent to the Web application, since it will enable the sending of the data required as many times as the user finds it necessary.
8. CIRCUTOR informs its users that the information can not be retrieved from the Web site, since it is sent in encrypted form to the Web application.
9. Each user will have a 10-report limit on the Web site with maximum age of 12 months.
10. CIRCUTOR reserves the right to modify these Conditions for Use at any time.

Legal information (LPD)

In compliance with Organic Law 15/1999, 13th of December, on the Protection of Personal Data, we would like to inform that the user data will be included in an automated file, property of CIRCUTOR, S.A., with the purpose of managing the service hired, whereby the user will authorise the treatment of the said data under the corresponding terms and conditions. The undersigned can exert their right to access, rectification, cancellation and objection of the said data at any time by writing to the address of the file's manager, CIRCUTOR, S.A., Vial Sant Jordi, s/n, 08232 de Viladecavalls (Barcelona).

After filling in the form, the user has to accept the conditions for use and click on “*Create user*” to validate the data and register the new user.

This is when the user is created with the registration form and already has access to the **CIR-e³Web** page. You will be able to send a maximum of 10 files and access the page an unlimited number of times to check and handle the information sent to the server.

Select “*Cancel*” to stop the user registration process and the application will return to the previous screen.

6.2.- DOWNLOADING THE XCG IDENTIFICATION FILE:

After the registration is complete, the data will be submitted semi-automatically and the SD card must have a file that is used by the system to know the address, as well as the Web space (user area) where the information is located.

Therefore, once you fill in the form and are registered in the system, download from the Web the file that will identify you during subsequent logins and which will be used to send data to the server. The file downloaded that identifies the user’s ID and sending address must be stored in the SD card. The file has *xcg* extension.

Therefore, the files generated with **CIR-e³** and sent by the user will be automatically sent to <http://cir-e3.circutor.com> and they will be located in the corresponding space, in order to allow the receiving user to access the data sent, as displayed on the Web page.

To generate and download the *xcg* file, access the Web page and fill in the “*login*” and “*password*” fields and open the menu in the “*Personal information*” tab called “*Generate XCG file*”.

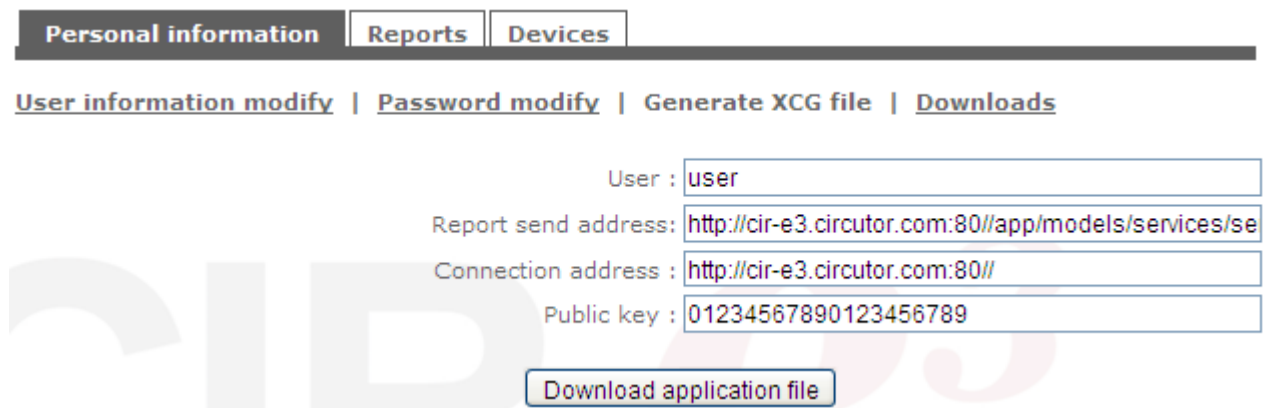

The information will displayed on the screen is generated automatically, absorbing the data entered by the user during his registration. You must **NOT** modify the data shown on the screen to prevent future errors when transferring files or preventing user identification errors in the **CIR-e³Web** application.

<i>User:</i>	User name
<i>Address:</i>	Web space address destined to the user
<i>Connection address:</i>	Connection address of the data server
<i>Public key:</i>	Data encryption key

After generating the data, press “*Download application file*” and the application will display the following screen, where you can select the file storage destination.

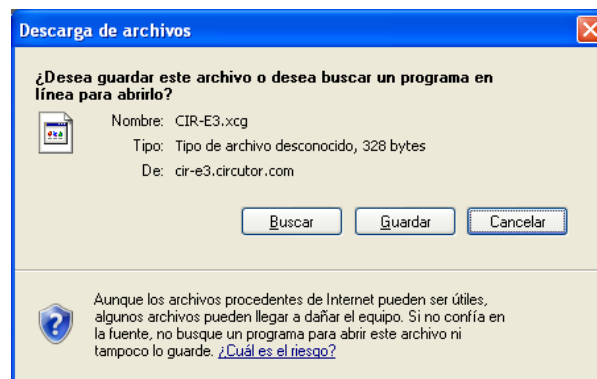

The storage destination must be the root directory of the SD card. This is the same location of the **CIR-e.exe** setup application.

6.2.1.- PERSONAL USER INFORMATION ON THE WEB

After enter the Web page, the application will show the following main screen.



The main screen shows a list of the user reports, in particular, those sent to the Web page. When you access the page for the first time, the screen does not show a list of the reports and indicates that there are no reports on the list with the following text "There are no reports to show".

As you can see, the screen has a top menu with three options "**Personal Information**", "**Reports**" and "**Devices**", which are described next.



This point provides a detailed description of the "**Personal information**" menu. The "**Reports**" and "**Devices**" menus are explained in detail in sections 6.10.1 and 6.10.2, since they correspond to subsequent data analysis stages.

This menu contains all information related to the user data. There are four sub-menus in the "**Personal information**" menu.

6.2.1.1.- User information modify

The personal information menu option opens the following setup screen. The "**User information modify**" screen is used to modify the data configured by the user in the registration form.

[Personal information](#) | [Reports](#) | [Devices](#)

[User information modify](#) | [Password modify](#) | [Generate XCG file](#) | [Downloads](#)

(*) Name :

(*) Surname :

(*) CIF :

(*) E-mail :

(*) Company :

(*) Phone :

Description :

(*) Time zone :

Note : Fields with (*) are required.

6.2.1.2.- Password modify

The second sub-menu in the “*Personal information*” menu is used to modify the Web page's access password defined by the user in the registration form.

[Personal information](#) | [Reports](#) | [Devices](#)

[User information modify](#) | [Password modify](#) | [Generate XCG file](#) | [Downloads](#)

(*) New password :

(*) Repeat new password :

Note : Fields with (*) are required.

To modify the password used to access the Web page, enter a new password in the “*New Password*” field and confirm it in the “*Repeat new password*” field. Press the “*Modify*” button after entering the new password. The new password will be saved.

6.2.1.3.- Generate XCG file

As explained in section 6.2 *Downloading the XCG identification file*, this sub-menu generates the file that identifies the user and his information and the sending address to the **CIR-e³Web** application. Click on “*Download application file*” to download the file.

6.2.1.4.- Downloads

The download sub-menu can be used to download the **CIR-e.exe** application file, which is vital to configure **CIR-e³** and which allows the download of the unit's manual. The unit configuration application and the complete manual are included in the SD card supplied with the unit. In any case, they are available in this section of the Web page as backup if the user deletes any of the files by mistake.

The screen shows the different download options.

[SD CIRe.exe application](#)[Link to Circutor downloads page \(CIR-e3\)](#)[Link to Circutor downloads page \(CIR-eQ\)](#)

To download any option, select the link.

6.3.- CONFIGURING CIR-E³

The **CIR-e³** analyzer does not have configuration buttons or a setup screen and it needs a file with the configuration information required to register the data. This file has the *xst* extension and it is generated with the **CIR-e.exe** application. This application is supplied with the unit and is stored in the SD card.

6.3.1.- GENERATING THE SETUP FILE

To generate the setup file, run the **CIR-e.exe** application located in the root directory of the SD card.



CIR-E

In the event that the SD card format from which the application is running is not a FAT16 format, the executable warns the user of an incorrect format using the following window:

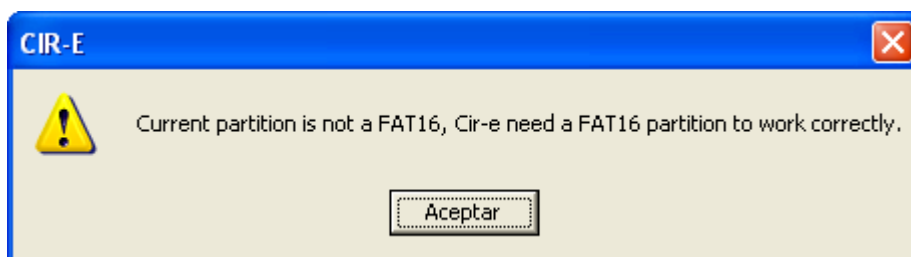

The application determines the installation parameters that will determine how the **CIR-e³** takes the measurements and records the parameters. These parameters are stored in the SD memory card. The setup application generates a file that must be stored in the SD card and which is named after the unit's serial number and has the *xst* extension. If the setup application is not available, you can also download it from <http://cir-e3.circutor.com>, in menu "User information".

When you run the application for the first time, the window will appear blank, as shown on the figure.

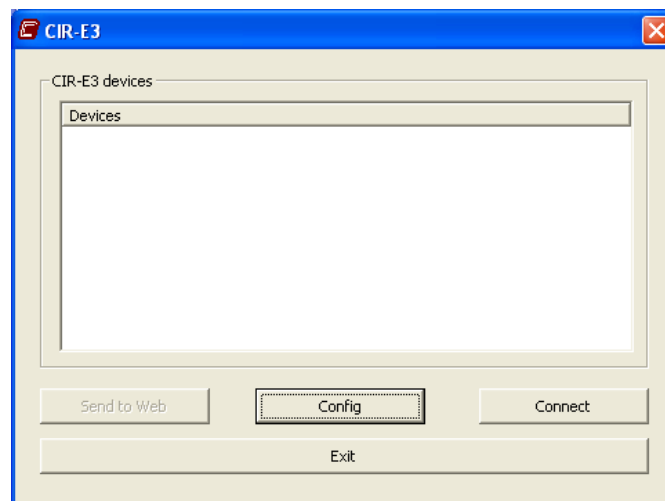

6.3.2.- MENU OPTIONS.

The application has 4 different function buttons. “Configure”, “Connect” “Exit” and “Send to Web”.

6.3.2.1.- Configure

Select the configure option to create a **new file with the installation's features for a CIR-e³**. The following window will be displayed when you click on “Configure”.

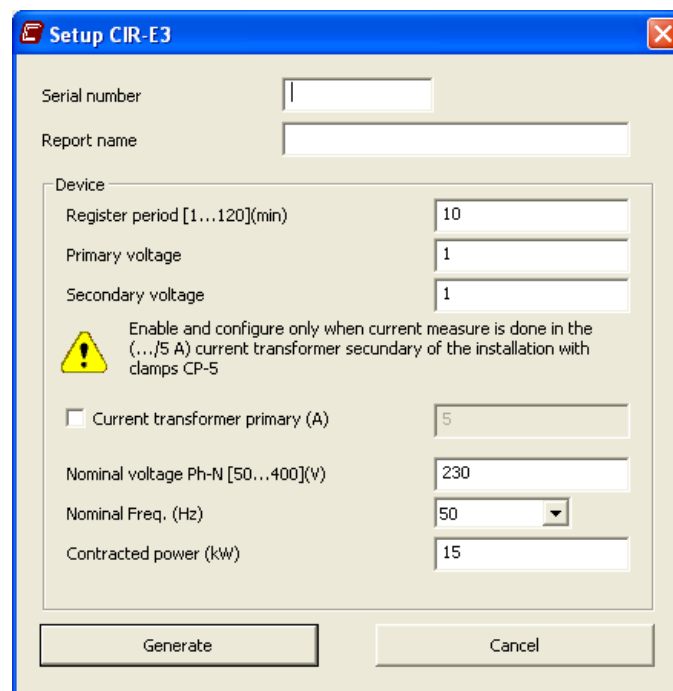

Serial number. Enter the 10 digits of the serial number of the **CIR-e³** unit used to take the measurements. The serial number identifies each individual unit. It is written on a label on the back of the analyzer: “*serial no.*” starting with 0102XXXXXX.

The serial number is used by the application as the data name (identifier). The setup file generated by the application will have the xxxxxxxx.xst format, where “xxxxxxx” corresponds to the last eight numbers of the unit's serial number.

Report name: You can enter the name of the file for identification purposes. This field is limited to 16 characters. For example, you can enter the name of the place where the measurements are going to be taken.

Register period: The registration period is a value that ranges from 1 to 120 minutes (2 hours) and it corresponds to a time interval during which we use to store the average of the records taken. The analyzer takes 128 samples per cycle of the signals measured. The registration period indicates the interval desired to take the weighted mean of all samples taken and it stores this value in the memory. For example, if you select a registration period of 1 minute, the analyzer calculates the mean of all samples of the variables registered during that minute and stores the results in the memory. From that period, the analyzer also stores the maximum and minimum values measured.

Primary voltage*: When using transformers to measure the voltage, enter the primary voltage value of the transformer. The information related to this feature of the transformer can be founded on a features label of the transformer. This label must indicate the primary ratio. In case you are not using voltage transformers and you are taking a direct measurement (up to 400 V p-n), the value entered must be 1.

Secondary voltage*: When using transformers to measure the voltage, enter the secondary voltage value of the transformer. The information related to this feature of the transformer can be found on a features label of the transformer. This label must indicate the secondary ratio.
In case you are not using voltage transformers and you are taking a direct measurement, the value entered must be 1.

	<p>the setup of voltage transformer relation has a limit that depends on some conditions which are defined with the range:</p> <table data-bbox="454 1323 1326 1431"> <tr> <td>1°. Primary voltage value</td> <td>between 1 y 220.000</td> </tr> <tr> <td>2°. Secondary voltage value</td> <td>between 1 y 999</td> </tr> <tr> <td>3°. Value of primary/secondary</td> <td>between 1 y 10.000</td> </tr> </table>	1°. Primary voltage value	between 1 y 220.000	2°. Secondary voltage value	between 1 y 999	3°. Value of primary/secondary	between 1 y 10.000
1°. Primary voltage value	between 1 y 220.000						
2°. Secondary voltage value	between 1 y 999						
3°. Value of primary/secondary	between 1 y 10.000						

Select the transformer ratio of the installation

This option should be selected in case of **CP-5** current clamps and measure in secondary .../5A. The selection of this field enable the configuration menu where should introduce primary current transformer ratio of the installation.

Primary current: in this field is introduce the primary transformer ratio of the installation. Maximum value of this field is limited to 10.000 (With the Power limit on 70.000.000).

Secondary current: The value of secondary is 5 A because the measure is made in the secondary of this current value with CP-5 clamps.

Nominal voltage (Ph-n): Enter the nominal voltage value between the installation's phase and neutral between 50...400V. That value has to be equal to the secondary of the voltage transformer if it is different to 1.

Nominal Freq.: Enter the nominal value of the installation's frequency. The values allowed for this field are 50 or 60 Hz.

Contracted power (kW): You can enter the installation's contracted power (this is only for information purposes and it does not have an impact on the unit's configuration).

After completing the configuration of **CIR-e³**, click on “**Generate**”.

When you select “**Generate**”, the software automatically creates file xxxxxxxx.xst in the root directory of the SD card (stored in the default directory). The name file is the same as the serial number of the unit entered in the setup menu, including the unit's configuration and installation's characteristics, as shown on the following figure. The unit will take this configuration when starting the measurements and the data will be recorded from the SD memory card.



12345678.xst

If you do not generate a setup file, store it in the root directory of the memory card or when the **CIR-e³** analyzer can not find the location of the memory card before the parameter recording process starts, it will automatically load a setup file that has a series of default parameters defined. The default file loaded by the analyzer is called “**Default**” and its features are described on the following figure.

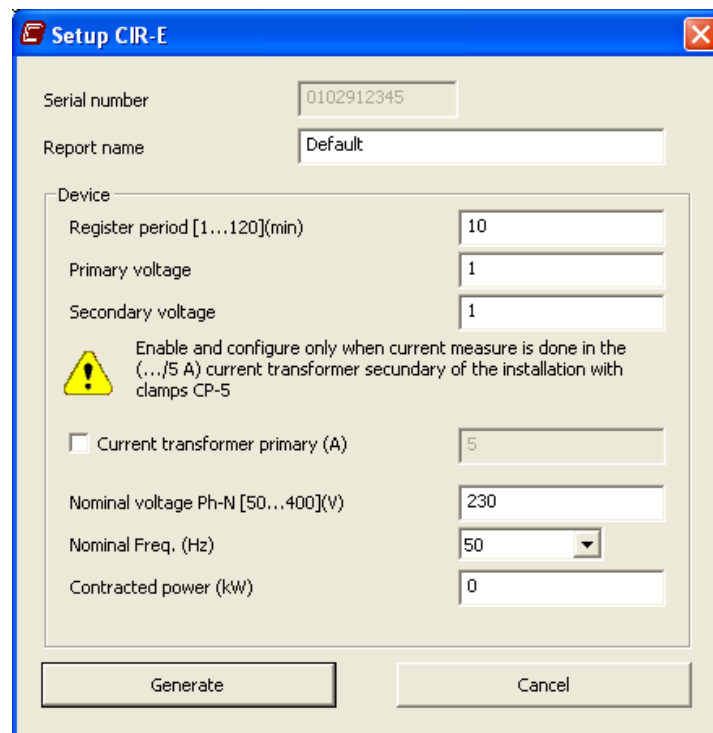

The screenshot shows the 'Setup CIR-E' dialog box with the following fields and values:

- Serial number: 0102912345
- Report name: Default
- Device section:
 - Register period [1...120](min): 10
 - Primary voltage: 1
 - Secondary voltage: 1
 - Warning icon and text: Enable and configure only when current measure is done in the (.../5 A) current transformer secondary of the installation with clamps CP-5
 - Current transformer primary (A): 5
 - Nominal voltage Ph-N [50...400](V): 230
 - Nominal Freq. (Hz): 50 (dropdown menu)
 - Contracted power (kW): 0
- Buttons: Generate, Cancel

Serial number: The serial number of the setup file is the unit's serial number.

Report name: The name of the report is “**Default**”.

Register period: Established as 15 minutes

Primary voltage: The transformer's primary value is 1 (direct measurement)

Secondary voltage: The transformer's secondary value is 1 (direct measurement)

Select the transformer relation of the installation

Current transformer primary: Is not enable in Default file configuration.

Nominal voltage (Ph-n): The standard nominal voltage is 230 Vac

Nominal Freq.: The standard frequency is 50 Hz.

Contracted power (kW): The default file does not include the contracted power

6.3.2.2.- Connect

Another option of the **CIR-e.exe** application is “Connect”. This option automatically connects with the main page of the **CIR-e³Web** application, as shown on the following picture.



CIR-e³

CIR-e³ is a portable high performance recorder designed for energy audits. Its design and easy operation make it ideal for carrying out energy studies.

The measurement unit has two connection wires: the first wire is used for power supply and voltage phase measurement purposes and the second one can connect up to three flexible current clamps (see the M5 catalogue for other types of clip).



CIR-e^Q

CIR-e^Q is a portable high performance recorder designed for detect quality network events. Its design and easy operation make it ideal for carrying out quality network supply.

The measurement unit has one connection wire:

- ✓ Auxilar power supply
- ✓ Voltage phase measurements

Login :

Password :

If you don't remember your password, you must click [here](#)

[Still do not have user?](#)



Small size



Plug & Play



Sealable



IP Protection



Easy connection

The purpose of this option is to allow the user to immediately access this Web application to display the data sent from the application, ensuring that the user must run other programs to access the Web.

6.3.2.3.- Exit

The “Exit” option closes the application and cancels the unit's setup file creation process.

6.3.2.4.- Send to Web

The “Send to Web” button will be explained in detail in section 6.9 *transferring data to CIRe3 Web*. This part of the manual talks about how the data recorded by **CIR-e³** analyzer are sent to the **CIR-e³ Web** data operation application.

6.4.- INSERT SD CARD

Insert the analyzer's SD memory card after creating the analyzer's setup file with the **CIR-e.exe** application and recording the file generated (with an xst extension) in the root directory of the SD memory card.



The SD card should be inserted in the card slot before starting the unit, if not the analyzer will be configured automatically with the default file described in section 6.3.2.1. *Configure*

VERY IMPORTANT:

	<p>Wait 12 seconds before starting the recording and insert the SD memory card in the unit. After completing the recording and stopping the data recording process with the <i>START/STOP</i> button, you must also wait 5 seconds before removing the memory card.</p>
---	---

	<p>The unit only detects cards with the FAT 16 format. If you use an SD memory card with a FAT 32 format, the unit will not be able to write on the card and it will display the error flashing the <i>REC</i> LED. Please do not use cards that have information you wish to store and perform backup copies of the information stored frequently.</p>
---	--

6.5.- START-UP SEQUENCE

The analyzer does not have a screen with the parameters being measured, so that you can not check whether the connection is correct. Therefore, we recommend follow the process explained in the following warning box. Follow the steps is important to read the error messages indicated by the analyzer.

	<p>Is required to follow this installation procedure:</p> <ol style="list-style-type: none"> 1. Insert SD card. 2. Insert A connector of current clamps. 3. Insert B connector, voltage references. 4. Power the analyzer. 5. Select the scale of the current clamps (in flexible clamps). 6. Check the voltage phase inversion. 7. Install the current clamps. 8. Check the installation of the current clamps. 9. Start the recording process.
---	---

After inserting the SD card in the analyzer's slot, connect it to start measuring and taking the readings of the installation's electrical parameters. The connection process is explained in detail in the following points.

6.5.1.- POWER AND CONNECT THE UNIT

Insert connectors “A” and “B”, corresponding to the references of the current and voltage sensors of the **CIR-e³** analyzer, respectively, before powering the unit. The analyzer is powered with the brown and green auxiliary power supply wires. When you connect the auxiliary power supply cables, the unit will makes the detection of current clamps connected.

If you power the unit and it identifies the current sensors connected are a single scale, the analyzer will detect them and it will be self-configured for the said scale (stored in its memory). This scale will be used to perform the calculations required to obtain all other electrical parameters stored in the memory. **CIR-e³** will start the boot sequence recognized by the sequential ignition of LEDs L1, L2, L3 and **POWER** LED. After boot process, start the connection error verification process to detect any connection errors in the voltage phases, as explained in section 6.5.3 *Verification of the connections*, of this manual (i.e., the user will not go through the scale selection process).

However, if you power the analyzer and it identifies the current sensors in connector A as sensors operating in more than one scale, the analyzer then moves onto the next step, which is the selection of the scale desired for the recording process (from the scales that can be used by the sensors connected). The three LEDs *L1/sc1*, *L2/sc2* and *L3/sc3* will start flashing, so that you can select the range desired to take the measurements pressing the button **START/STOP**. After scale selection, the device will start the boot sequence recognized by the sequential ignition of LEDs L1, L2, L3 and **POWER** LED. After boot process, start the connection error verification process to detect any connection errors in the voltage phases, as explained in section 6.5.3 *Verification of the connections*, of this manual.

Once the boot sequence is done the device indicates that is powered by the LED **POWER** on.



After powering the unit, connect the phase voltages. If you need to power the measurement's analyzer, you can connect the reference voltages to power it.

Before powering the unit, it is important to connect (not install) the current sensors, since the analyzer will identify the current sensors connected after it is powered, in order to store their scale in the memory.



If you power the unit without connector “A” of the current clamps, the unit will be configured with the 5 A clamp scale. To configure a different scale, turn the unit off so that it can reset the scale selection process.

The procedure followed to select the scale desired manually when using current sensors for various scales is explained in detail in section 6.5.2 *Selecting the scale*, of this manual.

To power and connect the analyzer correctly, respect the phase sequence, as shown on the table.



The colours of voltage phases can change according to the colour scheme selected in the device code. The following table lists the references for each phase of the different colours.

PHASE	EUROPEAN	RYBLB
Phase reference	Wire colour	Wire colour
(L 1) PHASE 1	BLACK	RED
(L 2) PHASE 2	RED	YELLOW
(L 3) PHASE 3	YELLOW	BLUE
(N) NEUTRAL	BLUE	BLACK
Auxiliary supply	BROWN	BROWN
Auxiliary supply	GREEN	GREEN

The connection diagrams show the unit's connection options. The connection diagrams show the connection options of the analyzer in single and three-phase installations with three or four wires (with neutral).

The analyzer's connection diagrams show the final voltage and current sensor connections, even though we recommend waiting until you reach the point in section 6.5.3 *Verification of connections* before installing the current sensors, in order to simplify the interpretation of error messages displayed in the LED while you are installing **CIR-e³**.

6.5.1.1.- Single-phase connection diagram

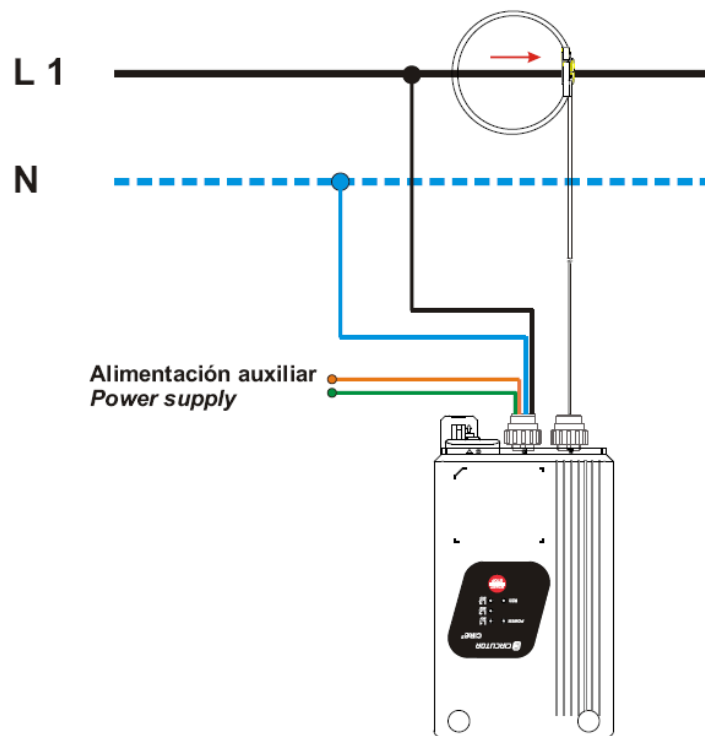

WARNING: in case of a single-phase connection, is essential that the phase connected to the installation was L1 with the reference of neutral.

6.5.1.2.- Three-phase connection diagram (3 wires)

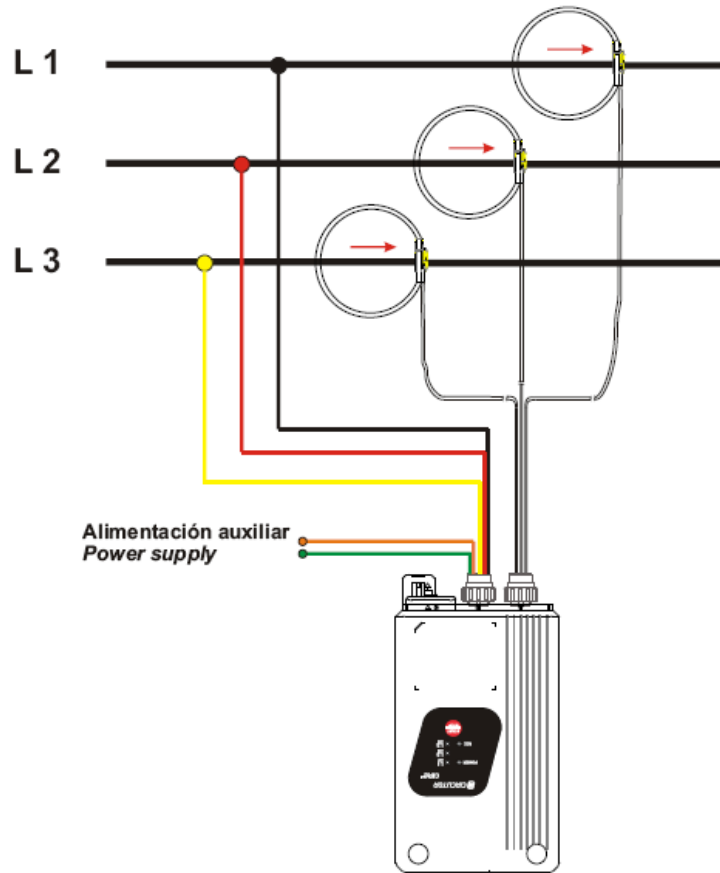

6.5.1.3.- Three-phase connection diagram (4 wires)

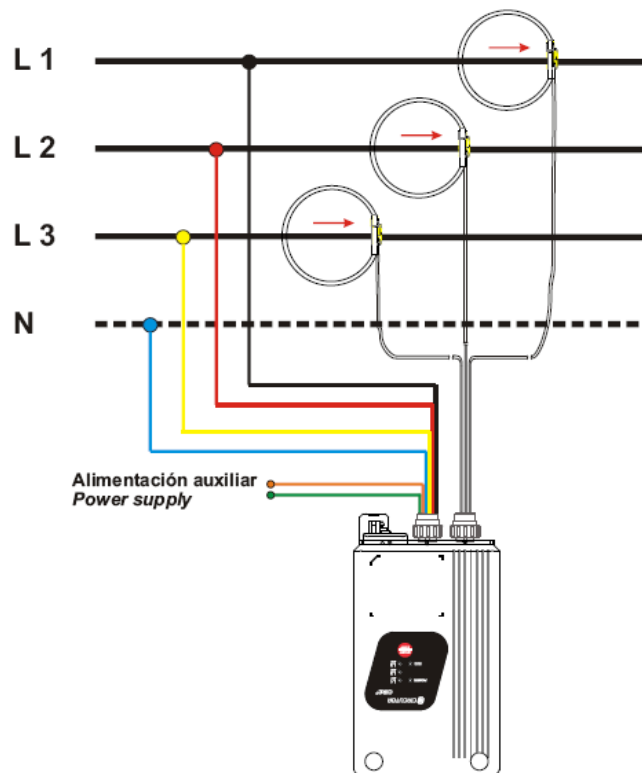

After powering the analyzer, configure the scale to record data after the flexible clamps have been connected. The unit's scale selection process is explained in the next section of this manual.

6.5.2.- SELECTING THE SCALE FOR FLEXIBLE CLAMPS

After inserting the voltage connectors and powering the unit, the *POWER* LED will turn on and search and detect the current sensors connected. When you have connected flexible current sensors, i.e., with more than one configurable scale to measure the current value, you can select the most adequate scale to take the readings, depending on the nominal current of each line you wish to measure, such as the current value, among other parameters.

Prior to the detailed explanation of the scale selection procedure, a table is attached with the features of the flexible current sensor, model *E-FLEX*, 54 cm long, included with the unit.

Clamp	Scale	Value	Measurement range
E-FLEX 54 cm	L1/sc1	200 A	5...200 A
	L2/sc2	2.000 A	50...2.000 A
	L3/sc3	20.000 A	500...20.000 A

For example, if the line where you wish to take the measurements has a nominal current of 150 amps, the most adequate scale to measure that nominal current value will be *L1/sc1* lower scale, which, in the case of the *E-FLEX 54* flexible clamps, corresponds to the 200 amp scale base. However, if the line where the measurements are going to be taken has a nominal current of, for example, 3.000 amps, you must select a higher scale, *L3/sc3*, which corresponds to the 20.000 amp scale base.

The scale selection procedure for the flexible clamp models is described next.

When you start the analyzer and it has detected that flexible clamps are connected, the three LEDs on the front panel of the unit will start flashing: *L1/sc1*, *L2/sc2* and *L3/sc3*.

The LEDs show that the unit is in standby mode until you manually select the desired scale. LEDs will flash **during 30 seconds** when the unit is waiting for the selection of the scale.

To select the scale manually, press *START/STOP*. When you press the button, the *L1/sc1* LED will start flashing, showing that you have selected the *L1/sc1* scale (in the case of *E-FLEX* clamps, it will correspond to the 200 amp scale). If you press *START/STOP* again, LED *L2/sc2* will start flashing (in the case of *E-FLEX* clamps, it will correspond to the 200 amp scale).

Finally, if you press *START/STOP* again, LED *L3/sc3* will start flashing (in the case of *E-FLEX* clamps, it will correspond to the 20.000 amp scale). This is how you can start a rotating work loop: *sc1 – sc2 – sc3 – sc1 – sc2 – etc.*, until you select the scale desired.

Let the LED flash after the unit has lit the scale desired to take the measurement.

When one of the three scales (*sc1*, *sc2* or *sc3*) is flashing during **7 seconds** and the **user does not press a key**, the unit will detect the scale selected by the user and store the configuration in its memory to start recording the information with the scale selected.

If you do not select the scale manually, i.e., while the unit is in the scale selection process, the *START/STOP* button is not pressed and the LEDs are flashing during **30 seconds**, the unit will configure the default scale automatically to start recording parameters. The **default scale** used to configure the unit when it has not been selected manually is **L2/sc2** (it corresponds to the **2,000 Amp** scale in the case of the E-FLEX 54 clamp).

After configuring the scale desired, the unit starts to verify the correct connection of the unit, as explained in detail in point 6.5.3 *Verification of connections*, always in the *STOP* mode, until user press the *START/STOP* button to start the recording, regardless of whether the unit has been self-configured (after the 30 seconds) or user has selected the scale manually (with the *START/STOP* button).

This is when the *START/STOP* button recovers its original function, *START* and *STOP* of the recording. When you press *START/STOP* during more than **3 seconds**, the unit starts or stops the recording, always on the same file. The unit will never create duplicate files or files with different names for each record.

If the unit is switched off in *START* mode (recording), when the supply comes again, the device restart automatically with the configuration, the unit will recover the last clamp scale configuration (if this scale is possible with the clamps detected) and it will automatically start recording, with no need to press the *START* button again, i.e, there has been an involuntary power supply interruption and the auxiliary power supply has been re-established. The unit detects clamps with a single scale after the power supply is reconnected, it will self-configure itself with the scale old related of the clamps and return to the recording status automatically.



If you select a different scale to the one that was configured before after the power supply interruption and system restart, the unit deletes the file with recorded data and generates a new one, including the new configuration selected.

If the unit loses the power supply in *STOP* mode, when the supply comes,(if the device has FLEX clamps connected) the unit is restarted in the scale selection procedure, blinking the three LEDs. If the user doesn't modify the clamps scale in **30 seconds**, the device restores the previous configuration and wait in *STOP* mode. If the user has modified the scale or configuration, when press *START*, the device will delete the old file of data and generate a new header to start a new file of parameters.

6.5.3.- VERIFICATION OF CONNECTIONS

The analyzer will start the connection verification process after you select the scale or the unit detects the single-scale clamps automatically. This process is carried out by the unit continuously, regardless of whether it is recording data or not.

We must highlight that the analyzer will indicate faulty connections with the same LEDs used during the scale selection process *sc1*, *sc2* and *sc3* in this case, the indication is realized by the lighted LED (correct connection) or blinking (incorrect connection).

The causes of faulty connections during a phase are explained next:

6.5.3.1.- Faulty connection

The analyzer can indicate a faulty connection for various reasons.

- Voltage sequence error.
- Current clamp not connected correctly or inverted.
- Power with a negative sign.
- Power factor (P.F.) is lower than 0.5 (angle > 60°).

	<p>A faulty connection can be due to a problem in the connection of the voltages or currents, so that we recommend following this procedure:</p> <ol style="list-style-type: none"> 1. Install voltages and check all connections 2. Install the current clamps and check all connections <p>Follow this procedure to check whether the flashing LEDs are due to an error in the voltage sequence or an incorrect connection of the current clamps.</p>
---	---

We recommend checking the connections of all voltages after installing the current clamps with the bus bars or installation's cabling measured and after selecting the scale. The unit will blink the *sc1*, *sc2* or *sc3* LED to indicate an incorrect installation sequence of the voltage phases.

The figure shows an example of how the **CIR-e³** unit indicates the faulty connection of voltages in phases L2 and L3. In this case, exchange the voltage connections, i.e., L2 and L3.



LEDs *L1/sc1*, *L2/sc2* and *L3/sc3* must be lit before installing the flexible current clips to the bus bars or measurement wire, as shown on the figure.



After connecting the voltage references of the **CIR-e³**, install the flexible current sensors supplied with the unit.

You must respect the installation position of the current sensors to guarantee the correct recording of the electrical parameters. To interpret the messages indicated by the *CIRe³* unit on the *L1/sc1*, *L2/sc2* and *L3/sc3* LEDs in relation to a faulty connection of the current sensors connected to the unit, we recommend installing the clamps one by one, in order to detect individual errors.

The correct position of the current sensors is shown on the clamp with an arrow that indicates the direction of current in the installation, from the main connection to the load point, as shown on the following figure.

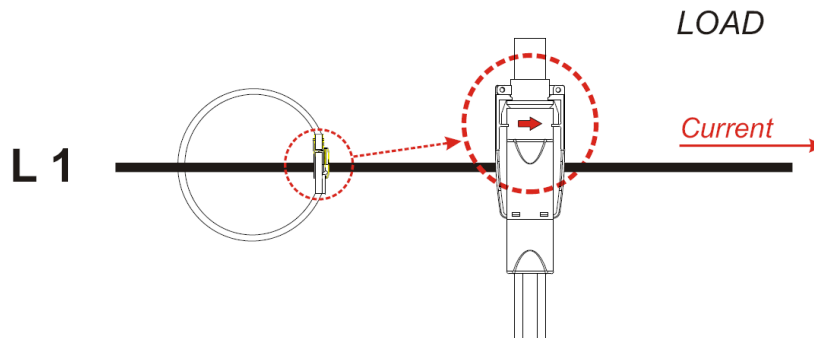

When the unit detects a faulty clamp connection, i.e., a negative power, an angle of more than 60°, the **Lx/csx** LED corresponding to the fault connection phase will start **flashing**. In this case, check the connection of the current clips to make sure that the installation follows the colour code and that the direction of the current clamps is as shown on the previous figure.



L1/sc1 *flashes*, indicating a faulty clamp connection. In this case, check the clamp to make sure that it is tightly closed and connected to observe the installation's current direction, as shown on the arrow, and that the clamp connected and identified with *L1*, *L2* and *L3* is installed in the corresponding phase, in accordance with the corresponding voltage colours, which are *BLACK*, *RED* and *YELLOW*, respectively.

Before starting the parameter recording process, the unit must have all phase LEDs lit and the current clamps must be installed, with no flashing LEDs. This means that the unit is powered and that all voltages and current clamps connected are taking the readings correctly.

The figure shows the LED status when it has been connected to a three-phase system before starting the parameter recording process with the *START/STOP* button.



6.6.- START/STOP BUTTON

After following these steps and making sure that the unit is connected, hold the red *START/STOP* button **during 3 seconds** to start recording the installation's parameters. When you hold the *START/STOP* button, the *REC* LED will be lit, indicating that the electrical parameters are being recorded as shown in the figure.



When you wish to stop the recording process, hold *START/STOP* **during 3 seconds** to stop and end the recording.



When the memory card is full during a recording, the unit will automatically change to the *STOP* mode and indicate the incident with the *REC* LED, which will start *flashing*.

To send the data stored in the SD memory card to the **CIR-e³Web** application, extract the SD memory card from the analyzer safely. To extract the memory card safely, follow the procedure described in section 6.7 *Safe extraction of the SD memory card*.

6.7.- SAFE EXTRACTION OF THE SD MEMORY CARD

To extract the SD card safely, make sure that the unit is not in the recording mode. The *REC* LED must be off. If the *REC* LED is on or flashing, stop the recording by pressing *START/STOP* before removing the SD card.



Removing the SD card while the unit is in the recording mode can corrupt the file stored in the memory and render it illegible.

6.8.- INSERT SD MEMORY CARD IN A PC

After inserting the SD memory card in the PC or SD card reader, run the **CIRe.exe** application in the root directory of the memory card.



With the **CIR-e.exe** application, you can send information recorded in the SD memory card with the **CIR-e³** portable analyzer to the **CIR-e³Web** application, which can be used to display the parameters and handle the information sent.

The procedure followed to send data is explained in section 6.9 *Transferring data to CIR-eWeb*.

6.9.- TRANSFERRING DATA TO CIREWEB



The maximum size of a file to send to the Web tool is 64 Mb. For larger files to use the software Power Vision or Power Vision Plus.

You must have an Internet connection to send data to the application. After inserting the SD memory card in the computer and running the **CIR-e.exe** application, as explained in the previous point, the following window will be displayed.

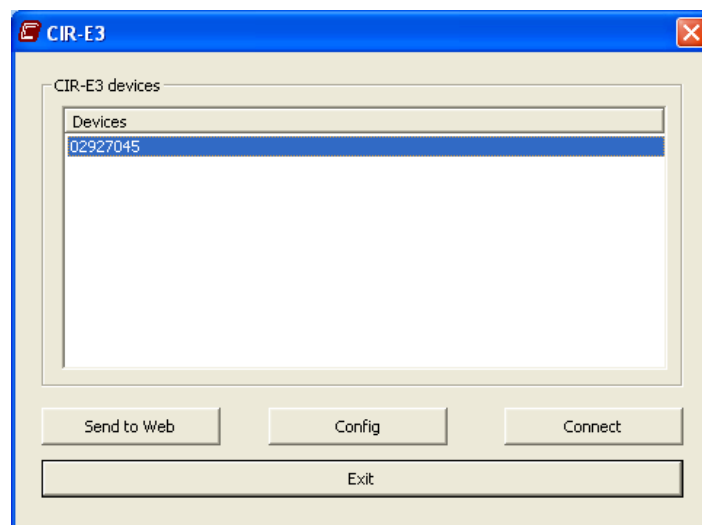

This window displays the list of files that have been configured with **CIR-e.exe** with the *xst* extension and which are in the root directory of the SD memory card.

To send the files recorded, select the file you wish to send to the Web application from the list displayed by the application and select the “*Send to Web*” option. This option is disabled when the window is opened, but it is enabled when you select a file.

If you select a file and click on “*Send to Web*”, the application will display the following screen to configure the report before it is sent to the application.

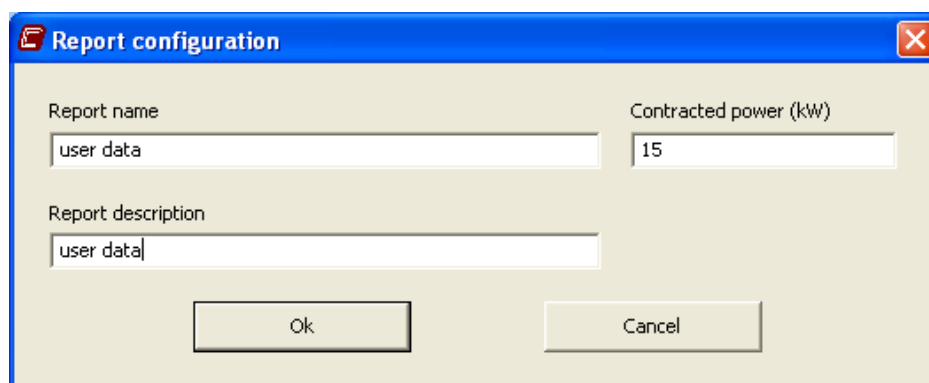

Data requested in this section:

Report name: The report configured before the data are recorded by the **CIRe.exe** application will be displayed by default in the space used to enter the name of the report. You can change this name. This field is limited to 16 characters.

Report description: Likewise, this space shows the name entered for the report. You can enter a description of the data report in this field if the name is not descriptive enough. This field does not have a character limitation.

To send the information to the Web application, confirm the data and click on “*Accept*” to send the data. When there is an error transferring data because of the size of the file or when the data file that must be encrypted and sent is not found (with an *std* extension in the root directory of the memory card), the application will display the following alarm window.

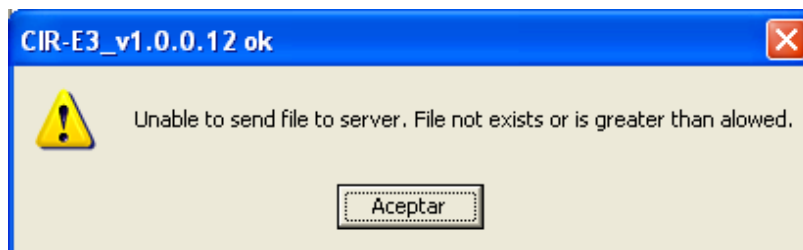

Click on “*Accept*”; if no errors are detected, the application will encrypt the data and send them to the Web page. During this process, the application will display the following window.

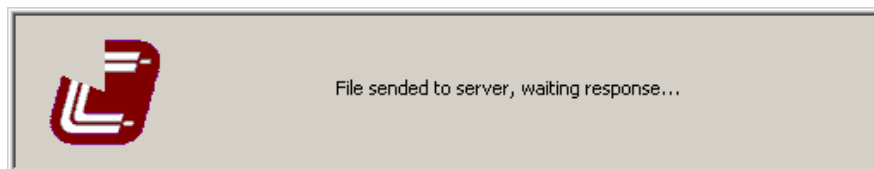

If there is an error in the data operation page, the application will display an error message with a numerical code of the fault indicating the reason for the error, displaying the following message: “**The file can not be sent to the server. Error code....**” The numerical error codes are shown on the following table:

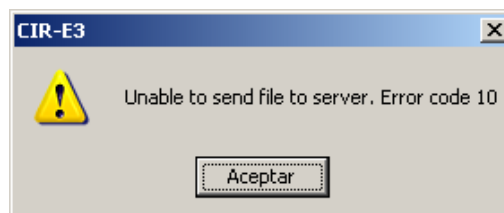

Code	Causes	Solution
0	The file could not be opened or it does not exist	Make sure that the *.std file is in the root directory of the SD card
1 to 16	Incorrect transfer or Web server function	Check the Internet connection
500	The user has exceeded the limit of 10 reports on the Web and not allowed to send another.	You must delete your account before posting new reports.

If the file sent to the Web application produces no errors, the application automatically generates a folder in the root directory of the SD memory card, with the same name as the unit's serial number entered in the **CIRe.exe** application and it will store the files with *std* and *xdt* extensions in the folder.

The files are stored automatically in the folder created by the application and renamed as follows: YEAR MONTH DAY HOUR,

For example, a file sent on the 10th of March, 2009 at 13:00h will be stored in the folder with a name that includes the serial number as follows: 09031013, as the backup copy of the data sent to the Web application.

When the information has been sent, the program will show a confirmation window.

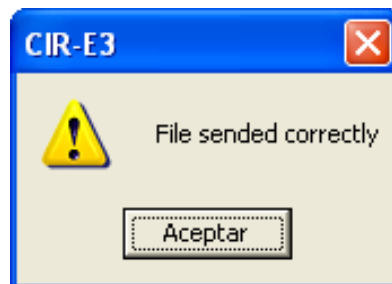

If you select “*Cancel*” in the confirmation window of the data recorded in the Web page the window will be closed and the data transfer process will be cancelled.

After the data recorded in the Web page is sent, you must connect to the web-based application to handle the information that has been recorded. To do so, click on the application's “*Connect*” option or follow the procedure described in the next point, *6.10 Analysis and display of data*.

6.10.- ANALYSIS AND DISPLAY OF DATA

You must connect to the Web page in the following address to handle the information transferred to the Web page:

<http://cir-e3.circutor.com> . Enter the page in the browser and the following application access screen will be displayed.

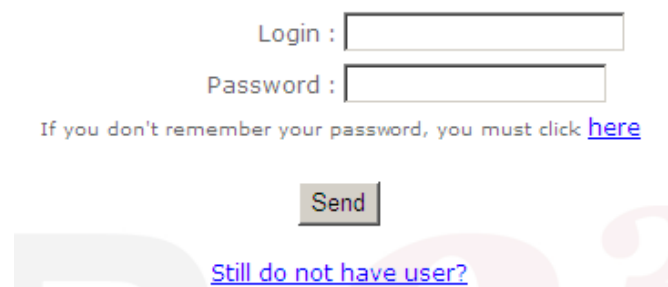

Login :

Password :

If you don't remember your password, you must click [here](#)

[Still do not have user?](#)

To access your account and view the reports sent, fill in the access data fields with your user registration information. To enter, click on “*Send*”

Login: Access name established during the registration process.

Password: Access password established during the registration process.

To go into Web tool ,press “*Send*”.

6.10.1.- LIST OF REPORTS

The main screen of the Web application shows the reports. It shows a list of the reports that the user has sent to the Web page. The information displayed in each column includes the file creation date, date when the information was transferred to the Web page, title of the report established by the application and serial number (which must be the same as that of the measurement unit).

Each user has a **maximum of 10 reports** in his Web address. If the user has yet the 10 reports when he try to send the next, the application will return error 500. The user has to delete some reports before sending any one more.

Recording final date	Release Date	Report title	User	Device serial number	Delete
2009-09-30 11:43:00	2009-09-30 13:20:01	Prueba Endesa	Carlos	02925048	

The information displayed on this screen can be ordered in ascending or descending order in each column by clicking on the arrow under the title displayed on the top of the table: (date of the report, date of reception, report title or serial number). Select a report to display the parameters recorded in a graph.

After selecting the report, the data will be displayed as explained in section 6.10.3 *Parameter selection menu*

6.10.2.- LIST OF DEVICES

The Web application has another menu on the top. "Devices" is another option. The device window shows a list of the units that have recorded information and which have been registered by the user. This information is available when you have used more than one analyzer to take the measurements that have been sent to the Web application.

Identifier	Description
90309160	Without description

The information included in the "Devices" menu option is explained next:

Identifier: Serial number of the unit that has sent a file to the Web application.

Description: This field is reserved for future applications.

6.10.3.- PARAMETER SELECTION MENU

When you select one of the files from the list of reports (described in section 6.10.1 *List of reports*), the Web application starts running and it displays a screen with various options. The top menu on the screen is displayed in the following figure.

The application shows all information of the file sent by default. Therefore, the application has a series of information filters. These filters are used to display only specific variables at each moment. The display options depend on the type of filtering option selected.



Filter type: Menu used to filter the information displayed. There are two options, as shown on the figure. Standard or harmonics.

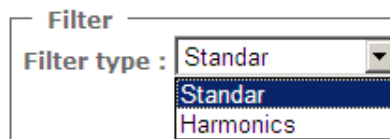

6.10.3.1.- Standard:

The standard filtering process can be used to individually select each variable recorded. To do so, use the drop-down menu displayed on the following figure. If you only select one variable, it will be displayed as if you select the “Zoom” tool, explained in point 6.10.5 Zoom.



The selection menu with the standard filter option is complete. You can select the instantaneous values, maximum and/or minimum values and three-phase values independently for each phase, as shown on the figure.



The parameters are displayed on a graph when you select the standard filter mode:

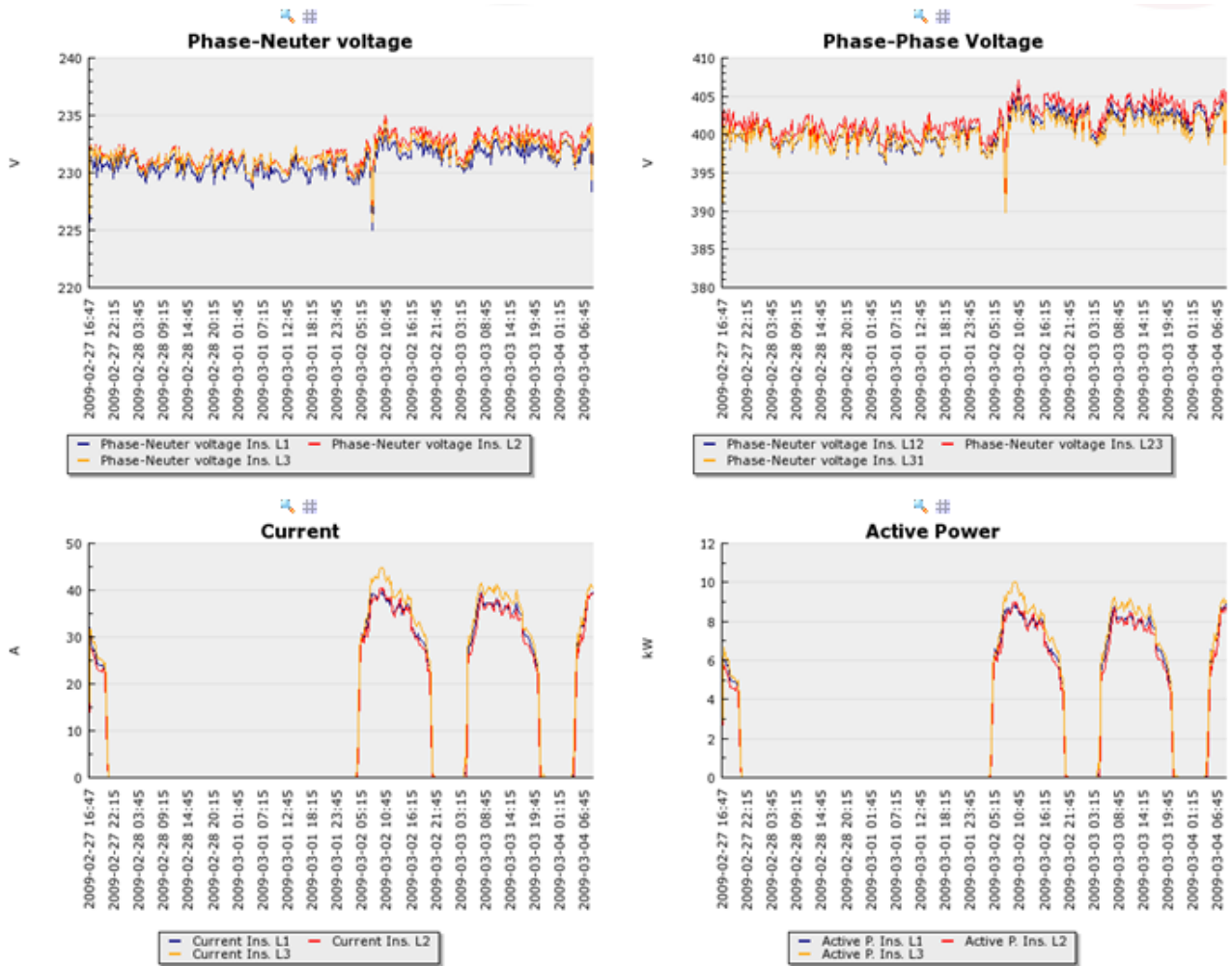

6.10.3.2.- Harmonics:

The information is displayed in a bar-chart when you select the harmonic filter mode.

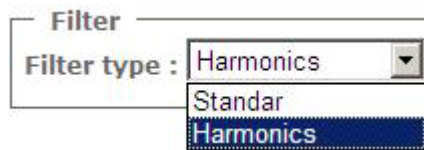

The default presentation screen is the voltage and current harmonics screen.

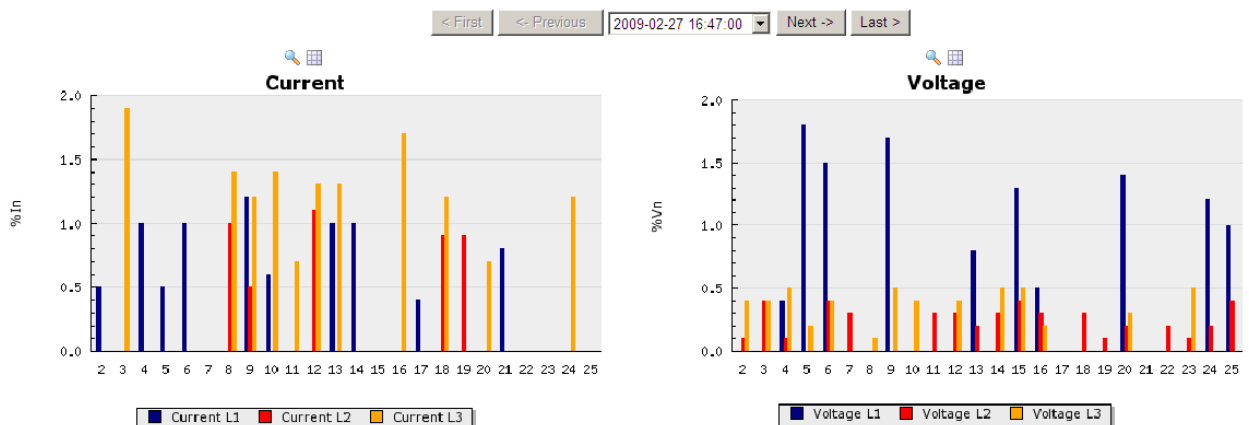

The harmonics menu can be used to individually select the variables using the filtering menu on the top part of the screen. The figure shows that the *Current*, *Voltage* or *All* Harmonics can be displayed independently.

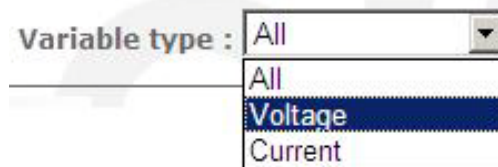

You can display each graph with more or less detail, depending on the selection. The graph is displayed on the screen as follows:

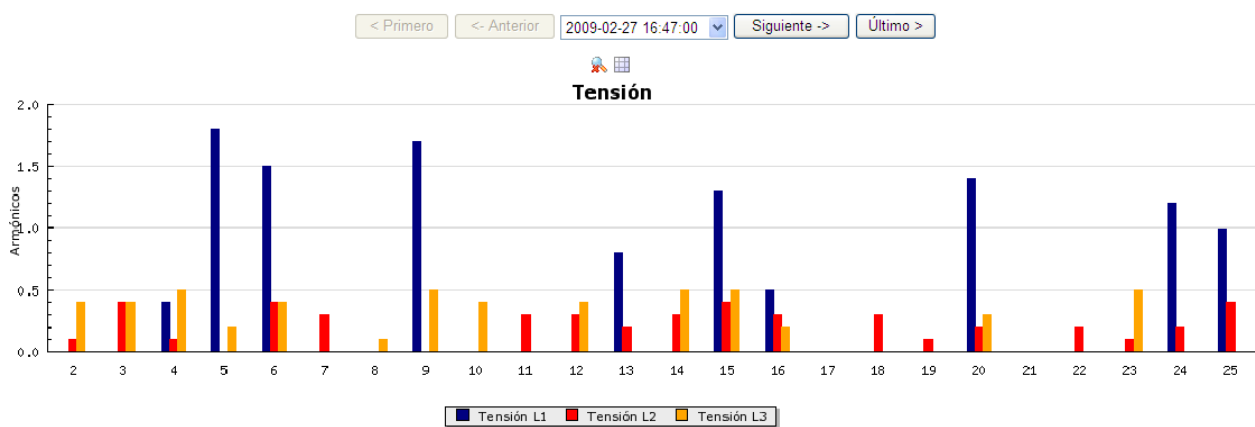

This harmonics graph can use the Zoom and Table functions to display the parameters recorded in a table as the representation of the values recorded during a standard filtering operation (see section 6.10.5 *Report graphs*)

6.10.4.- REPORT INFORMATION

This part of the visualization screen of parameters recorded and sent to the Web application displays all information related to the configuration of the measurement installation and the parameters configured by the unit used to take measurements.

Report information :

Report : User Data
Description : User Data

Report date : 2009-03-04 08:45:00
Release Date : 2009-05-05 11:17:32

Contracted power(kW) : 15
Active rate : 0
Register period(sec) : 900
Nominal Voltage(V) : 230
Voltage conversion ratio : 1/1
Current conversion ratio : 2000/5

The data displayed is as follows:

Report and Description: Displays the name of the report and its description, as used to configure and send files to the Web application.

Date of the report: Date when the parameters were created or recorded by **CIR-e³**

Date of reception: Date when the user transferred the data to the Web page.

All other information displayed in the report setup menu corresponds to the parameters configured with the **CIR-e.exe** application, which also corresponds to the features of the installation where the parameters were recorded. The information is related to the nominal voltage and frequency, contracted power, voltage transformer ratio and the configured scale ratio for the current sensors taking the measurements.

6.10.5.- REPORT GRAPHS

The report graphs are also grouped in a menu.

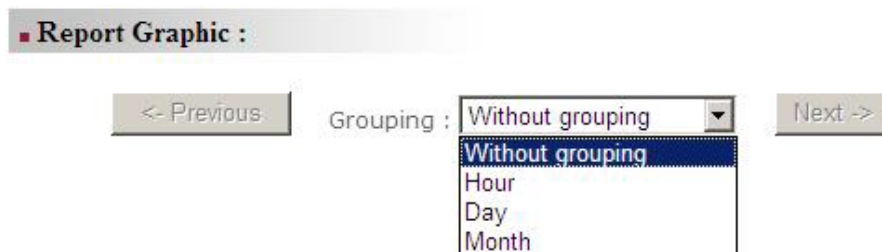

Select "**Not grouped**" to disable the Previous / Next buttons. In any case, the whole values of the records will be displayed on the graphs.

Select "**Hour**", "**Day**" or "**Month**" to disable the *Previous/Next* scroll buttons and jump to the previous "**Hour**", "**Day**" or "**Month**" found in the file sent to the Web. Therefore, the application will group all information recorded by the analyzer and sent to the Web in days, hours or months. This is how you can analyze shorter periods with an independent approach. Use the Previous / Next buttons to scroll through the parameters recorded until you reach the desired interval.



This part of the screen shows the values of the variables recorded in the file on a graph. It displays the values selected in the selection menu described in section 6.10.3. *Selecting parameters.*

The top part of the graphs displayed on the parameter display screens show the *Zoom* and *Show table* icons, which are explained next.



Zoom:

The *Zoom* tool zooms in or out selected graphs and shows the whole screen. This tool is useful when you wish to copy the graph and add it to a different document.

■ Gráficas del informe :

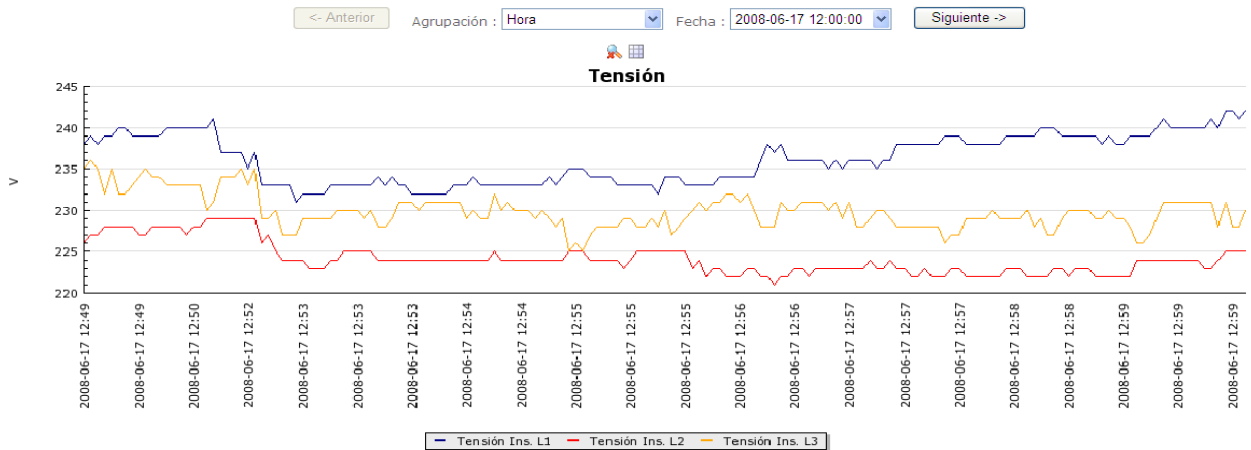

To export the images displayed in the Web-based application to a different document or format, right-click “*save image as*” and save the images in a folder. These can be retrieved later on when you wish to add them to a different document.



Show table:

The “*Show table*” tool opens a window that shows all values registered by the analyzer on a table.

The Show table tool does not have a menu to group values, as shown in the graph display option. The values on the table have been stored in this file.

Fecha	VI1	VI2	VI3
2008-06-17 12:49:20	238	226	235
2008-06-17 12:49:20	239	227	236
2008-06-17 12:49:25	238	227	235
2008-06-17 12:49:30	239	228	232
2008-06-17 12:49:30	239	228	235
2008-06-17 12:49:35	240	228	232
2008-06-17 12:49:35	240	228	232
2008-06-17 12:49:40	239	228	233
2008-06-17 12:49:45	239	227	234
2008-06-17 12:49:45	239	227	235
2008-06-17 12:49:50	239	228	234
2008-06-17 12:49:50	239	228	234
2008-06-17 12:49:55	240	228	233
2008-06-17 12:50:00	240	228	233
2008-06-17 12:50:00	240	228	233
2008-06-17 12:50:05	240	227	233
2008-06-17 12:50:05	240	228	233
2008-06-17 12:50:10	240	228	233
2008-06-17 12:50:15	240	229	230
2008-06-17 12:50:15	241	229	231

To export the tables in the Web application to a different document or format, select part or the whole table and right click “*Copy*” to save the table temporarily in the Windows clipboard. Open the document where you wish to paste the table and right click “*Paste*”, to add the table on any part of the document.



Print:

The option “print” implements a restructuring of the information displayed in the screen that allows that the user can print all the information in a single document. This option includes the header of the report and the selected graphic.

7.-FAQS

❖ *Can I start recording when the phases LEDs start flashing?*

When LEDs start to flash, we recommend checking the installation to make sure that there are no connection faults. If the LEDs continue to flash after you have checked the connections, you can start the recording since this is probably due to a power factor under 0.86 (in any case, it is a real power factor value of the installation).

The recording process can not be started when the REC LED is flashing, since this indicates a card write error, due to the following causes:

❖ *Can I start recording when the REC LEDs start flashing?*

Is unable to start the record if the REC LED is blinking because indicates a writing SD card error, because of these possible causes.

- No memory card inserted in the unit's SD card slot.
- The memory card inserted does not have the correct format or data can not be written. (for example, if the card is write protected or it has a FAT32 format; please change the format of the memory card to **FAT16**).

❖ *Why has the STD file been deleted from the root directory of the memory card?*

The STD file can be deleted from the memory card's root directory for the following reasons:

- The user has changed the configuration of the clamps when powering the analyzer. This modifies the file header, deleting the file stored in the card and the energy value accumulated.
- You have powered **CIRe³** without inserting the SD memory card in the unit. This loads the "Default" file with the specific setup. When you insert the memory card, the analyzer detects the new setup file. This is interpreted as a modification of the setup and the unit proceeds with the process explained in point 1.
- When the unit sends the data to the Web application, the application creates a folder with the unit's serial number and it stores the file, renaming it with the date-day-hour when it was sent. The file might be stored in this folder if you have sent it to the Web application.

❖ *Why does the list of clamps not correspond to the selected scale?*

Basically, there are two reasons why the analyzer is configured with a list of current clamps that has not been established by the user:

- You have not followed the scale selection process correctly, as established in the manual.
- You have powered the analyzer while the current clamps (A connector) were not connected, so that the unit has not detected the clamps and is automatically configured with a 5 amp scale. If you then connect the clamps and restart the unit, the file header will be modified, so that the file that has recorded the data and the cumulative energy meter information will be deleted.

❖ *Why is the recording period different from the period you have configured?*

If the analyzer does not find the setup file from the root directory of the SD card, it is self-configured with the "Default" file, which has a 15 minute registration period.

- ❖ *What happens when the user enters an incorrect serial number when generating the setup file with the PC application?*
If you have created a setup file with the wrong name, i.e., the analyzer's serial number entered is incorrect, the analyzer will not use it as the unit's serial and it will configure itself with the "Default" file.
- ❖ *Is there another way to analyze the data recorded by the analyzer?*
There is the option to analyze the data recorded on a computer, without send data to the Web. Use Power Vision or Power Vision Plus.
- ❖ The software can not open a file. What could happen?
 - The card is corrupted due to unsafe removal from the device.
 - The card is unreadable or write-protected.
 - The file has been registered with a date that is not interpreted by the program. This date is generated when the device loose battery charge.
- ❖ The data is recorded with an incorrect date. Why?
The device records with the default date 01/01/2011 00:00h when the battery is empty and is unable to maintain the clock.
For devices with rechargeable battery, connect the device for 12 h to recharge the battery and configure the data.
For devices with non rechargeable battery, change the battery for a new one.

8.-CIR-E3 INSTALLATION VIDEO

CIRCUTOR, SA made available to CIR-e³ users an example video of most common errors and how to install the analyzer. It's available on the Web sites:

www.circutor.es

www.circutor.com

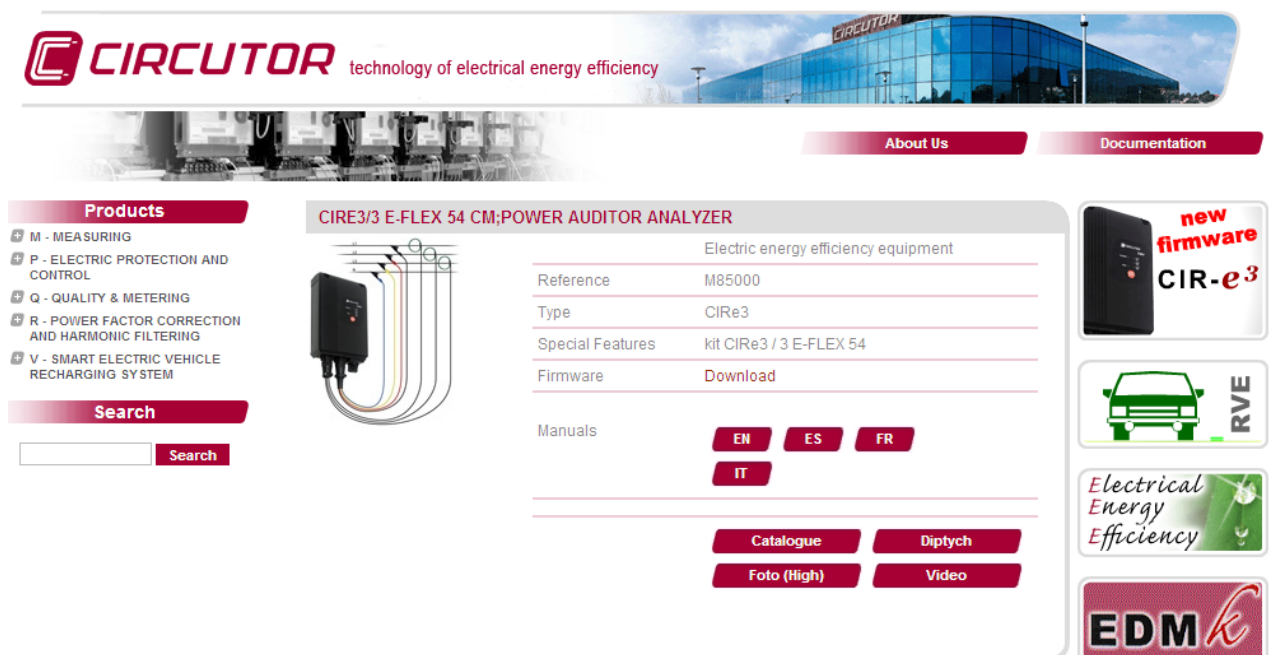

The screenshot shows the CIRCUTOR website interface. At the top, the CIRCUTOR logo is followed by the tagline "technology of electrical energy efficiency" and a background image of a modern building. Navigation tabs for "About Us" and "Documentation" are visible. The main content area features a "Products" sidebar with categories like "M - MEASURING", "P - ELECTRIC PROTECTION AND CONTROL", "Q - QUALITY & METERING", "R - POWER FACTOR CORRECTION AND HARMONIC FILTERING", and "V - SMART ELECTRIC VEHICLE RECHARGING SYSTEM". A search bar is also present. The central product page is for the "CIRE3/3 E-FLEX 54 CM:POWER AUDITOR ANALYZER", showing its reference (M85000), type (CIRe3), special features (kit CIRe3 / 3 E-FLEX 54), and a "Download" link for the firmware. Below this, there are buttons for manuals in different languages: EN, ES, FR, and IT. Further down, there are buttons for "Catalogue", "Diplych", "Foto (High)", and "Video". On the right side, there are promotional banners for "new firmware CIR-e3", "RVE" (Renewable Vehicle Efficiency), "Electrical Energy Efficiency", and "EDM".

9.-REGULATIONS

ELECTRICAL SAFETY REGULATIONS

- IEC 60664-1 Insulation of low voltage equipment
- IEC 61010-1 Electrical safety
- IEC 62053-21 Active energy meters (class 1 and 2)
- UL 94 Enclosure flammability test
- VDE 110 Low voltage equipment insulation

ELECTROMAGNETIC EMISSIONS

- IEC 61000-3-2 Harmonics
- IEC 61000-3-3 Voltage Fluctuations
- IEC 61000-6-4 Industrial Emission
- EN 55011 Radioelectric alterations. Industrial, scientific and medical.
- EN 55022 Radioelectric alterations. Information technology equipment.

ELECTROMAGNETIC IMMUNITY

- IEC 61000-6-2 Industrial immunity.
- IEC 61000-4-2 Electrostatic discharge
- IEC 61000-4-3 Electromagnetic, radiated and radiofrequency fields
- IEC 61000-4-4 Quick transient bursts.
- IEC 61000-4-5 Shockwave.
- IEC 61000-4-8 Magnetic field at the industrial frequency
- IEC 61000-6-1 Domestic immunity.
- IEC 61000-4-11 Interruptions, gaps and power supply variations.
- ENV 50141 Radiofrequency in common mode.

PROTECTION DEGREE:

- IEC 60529 Enclosing protection degrees.

HOUSING SYMBOLS



Maximum input voltage 400 V



Reinforced insulation



■ Product manufactured with recyclable and reusable material. Do not dispose with domestic wastes. At the end of its lifespan, deposit the product at a specific collection point meant for electrical or electronic devices. REI-RAEE register (ES) N°: **3338**.

10.- TECHNICAL SERVICE

Please contact the after sales service or technical service of **CIRCUTOR, S.A.** in case you have a question about the unit's operation or you have detected a fault.

CIRCUTOR S.A. - After Sales Service.

Vial Sant Jordi, s/n
08232 - Viladecavalls.
Tel: (+34) 93 745 29 00
Fax: (+34) 93 745 29 14
E-mail sat@circutor.es

11.- FEATURES OF CIR-E³ CLAMPS

11.1.- E-FLEX 54

E-FLEX 20 BUILT-IN AMPLIFIER

Flexible current sensor



TECHNICAL FEATURES

Características eléctricas	
Typical voltage output E _{OUT} RMS	2 V FS
Frequency range	20 Hz ... 10 kHz
Working voltage	600 V a.c.
Rated primary current	20kA/2kA/200A
Lineality (10% to 100%)	
Temperature Coefficient max.	+/- 0.2%
Position sensibility	+/- 0.05%
External fields	+/- 3%
Electrical safety	+/- 2%
Isolation	Double Isolation
Protection class	II IEC/EN 61010-1:2001
Overvoltage Category	CAT III
Working voltage	600 V _{RMS}
Pollution degree	2
Dielectric strength	IEC/EN 61010-2-32:2002, 5,4 kV 50 Hz

PRODUCT

The non-intrusive flexible current sensor provides the ability to measure alternating current in any installation with a full rejection of DC component, very low power consumption, no saturation problem, very low temperature dependence, very good linearity. The built-in electronics, integrate and amplify this signal to finally have a voltage proportional to the current.

Improvements in these electronics are capable to obtain measurements of alternating currents from 20 Hz to 10 kHz with a very good linearity and no phase displacement. These conditions make this transducer ideal for measuring power and energy parameters.

The electronic facilities are now built in the flexible coil junction. This adds a much bigger advantage due to the fact that external electronic transducer can be eliminated. The sensor output signal (normally 2V a.c. FS) will be obtained directly from the flexible current transducer, although it will have to be powered from an input power supply of 9 -12 Vdc (normally coming from Analyzer battery).



SAFETY PRECAUTIONS

The current flex sensor has been designed and tested to fulfil the safety standard IEC 61010-1: 2001 61010-2-32:2002. Prior to use the current flex sensor for the first time, read the following carefully:

1. The probe must be only used by qualified personal.
2. Use of the probe on uninsulated conductors is limited to 600 V a.c. or DC to frequencies below 1kHz.
3. Do not expose the probe to aggressive or explosive environment.
4. Do not use the probe if there any reason to think that its no operating properly or that it is faulty.
5. For measuring in uninsulated conductor use the appropriate and necessary personal protection equipment.

PHYSICAL AND ENVIRONMENT FEATURES

Probe Material	Self-extinguishable UNE 21031 90°C
Couplings Material	PA V-0
Probe Cable Diameter	14 mm
Output Cable length	2 m
Temperature Range	-20 ... +85 °C
Storage temperature	-40 ... +85 °C
Relative Humidity	15 ... 85% (without condensing)
Protection	IP 65

SYMBOLS



Attention! Refer to manual



Double Isolation



According to CE standar



Not use under voltage



Vial Sant Jordi s/n - 08232 - Viladecavalls (Barcelona) Spain
Tel: (+34) 93 7452900 - Fax (+34) 93 7452914 - central@circutor.es

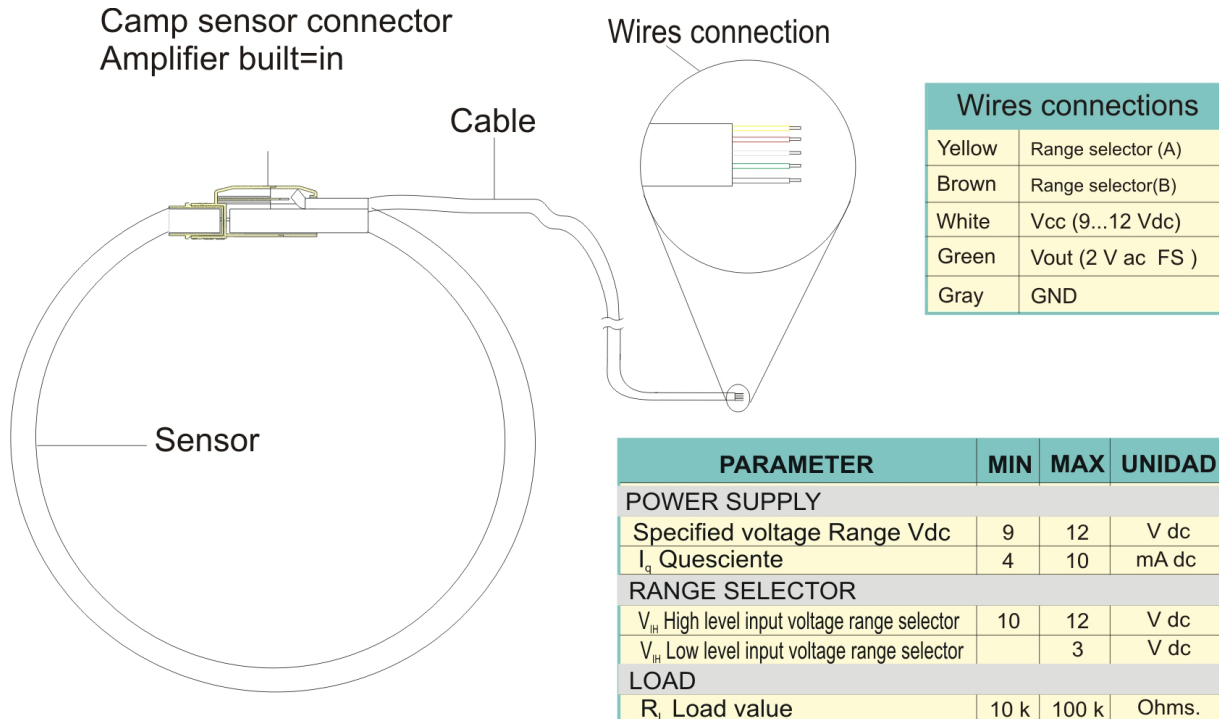

EXTERNAL CONNECTIONS

The built-in electronics should be externally supplied in the range 9 to 12 Vdc. It is recommended 12 V for the external supply to better results (Trough of Vdc and GND wires).

For the measuring range control there is an internal multiplexer that should be externally controlled too (Trough of A and B wires).

USING THE CURRENT SENSOR

1. Before using the current flex sensor ensure that the conditions are the appropriate for working, and that the protection equipment is the adequate.
2. Ensure that the wires connection are configured correctly
3. Disengage the snap connector and surround the conductor to measure.
4. Close the snap connector ensuring their anchorage.
5. Put the conductor centred within the sensor.

MAINTENANCE

The current flex sensor do not require a special maintenance.

TYPE				
TYPE	SENSOR LENGTH	RANGES	SENSIBILITY	V _{out}
E-FLEX20	54 - 80 - 120 cm	20kA/2kA/200A	0.1mV/A;1mV/A;10mV/A	2 Vac
E-FLEX15	54 - 80 - 120 cm	15kA/1.5kA/150A	0.13mV/A;1.3mV/A;13mV/A	2 Vac
E-FLEX10	54 - 80 - 120 cm	10kA/1kA/100A	0.2mV/A;2mV/A;20mV/A	2 Vac
E-FLEX6	54 - 80 - 120 cm	6kA/0.6kA/60A	0.33mV/A;3.3mV/A;33mV/A	2 Vac

11.2.- CP-5 Y CP-100



The clamps are CP family of rigid models. CIR-E3 enables the use of CP5 and CP100 models rated currents being drawn 5 and 100 amps respectively..

The housing of both models, CP-5 and CP-100 is the same.

The dimensions of CP-5 and CP-100 clamps are:

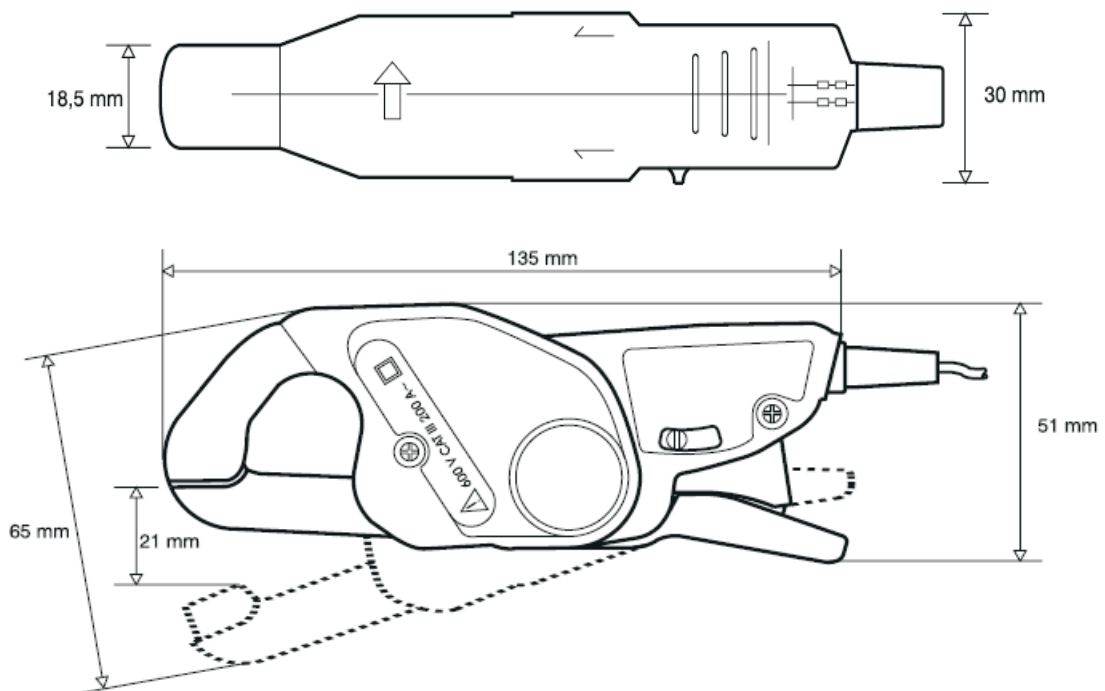

The electrical :

Model	Range	Frequency	Dielectric strength	E. S. Error	Máximum diameters
CP-5	0,05...5 A	48...65 Hz	5200 V 50Hz 1 min	1%	Ø 20 mm
CP-100	1...100 A	48...65 Hz	5200 V 50Hz 1 min	0.5 %	Ø 20 mm

12.- BATTERY CHANGE

Pre-2012 analyzers have a rechargeable battery. In case of malfunction must plug for 12 hours to charge the battery. After that must set the time of the analyzer as described in Chapter 13 Setting the time of the analyzer.



To proceed to change the battery, disconnect the scanner from any source of voltage and current measurement and power

Is recommended change the battery each 5 years. To change the battery (for models from 2012) remove the 7 screws on the back of the analyzer and remove the back cover.

You must respect the position of the battery as shown in the adhesive as shown in the following picture

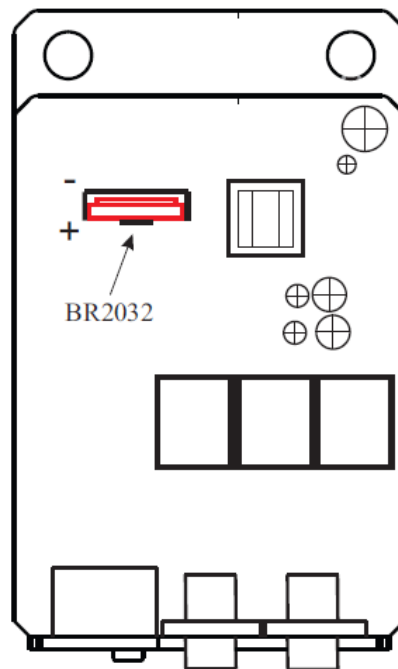

After changing the battery of the device must be set the time and an hour. To set the time should follow the instructions in Chapter 13. Setting the time of the analyzer

13.- SETTING THE TIME OF THE ANALYZER.

User must supply and connect the device to de PC, using the wire communications given with the device. This cable has one four-pin connector (CIR-e) and at the other end is a DB-9 (PC).

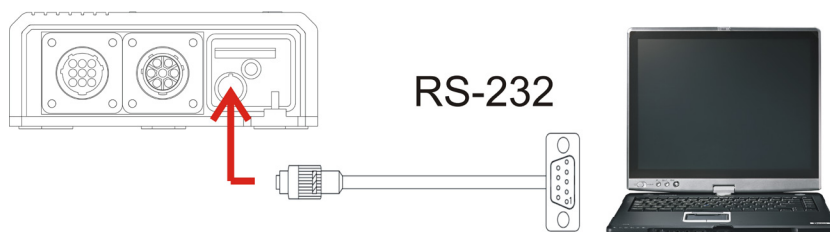

(See instruction manual to verify connections and maximum voltage of the device)

Once you supplied the device, keep the instructions below.

	<p>To start the update of the analyzer, the device can't be in record mode, must be in STOP mode and finished the boot process.</p>
---	--

The user must run the update program CIR-e from the directory installed. The user must set up the configuration of communications in order to communicate with the device. Select COM of [1] Setup COM.



To communicate with the device the user has to follow the instructions explained in chapters before.

Once the program has communicated with the device, the user must select in the menu [4] Time UTC, the option Read.

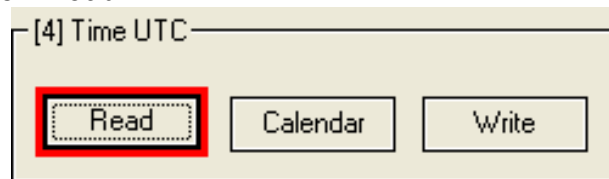

The application shows in the line of text the time UTC that the device has configured.

```
(CPU-Measure). Send to SRAM ...
(CPU-Measure). Send Test Flag
(CPU-Measure). Saving program to flash.
(CPU-Measure). WAIT. Saving Program...
Measure Version Updated: CIR-E3 -405- 1.18
Update Done
Info: TIME UTC Read: 05/11/2009 08:36:36
```

To modify this time, select “Calendar” to introduce the new time to the device.

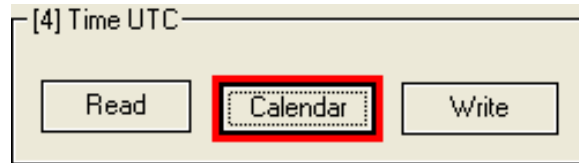

This option shows the “SETUP CALENDAR” screen.

UTC Time. This part is informational only and shows the conversion to UTC time settings according to user-entered in the field below “*Local Time*”.

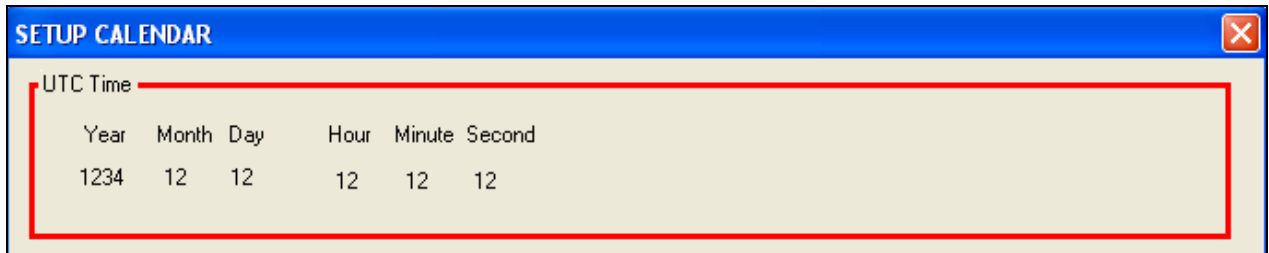

Local Time. In this field the user must enter the local date and time and indicate in the selection field “*Summer*”, if you are applying DST.

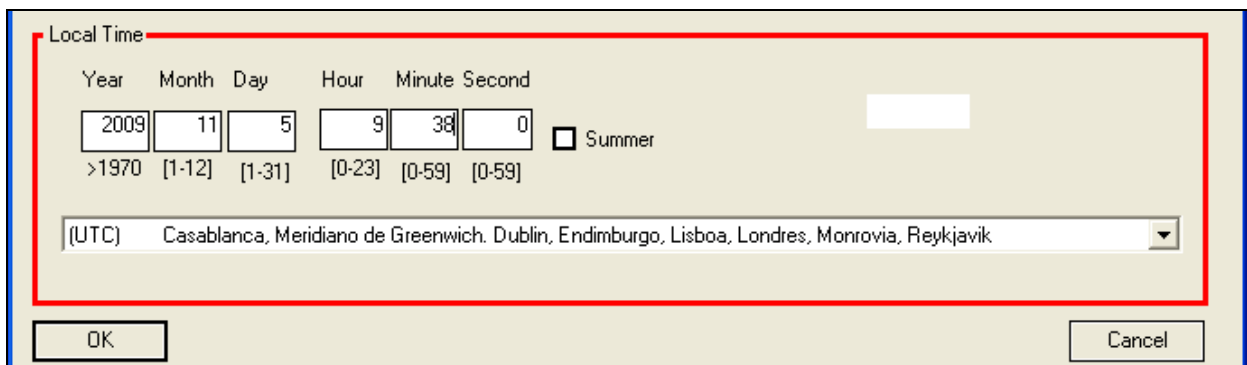

The lower field is a dropdown menu for the user to select the time zone in which it is located. With all this information on applying calculations UTC time is displayed in the “*UTC Time*”.

Now push **Ok** to introduce all data.

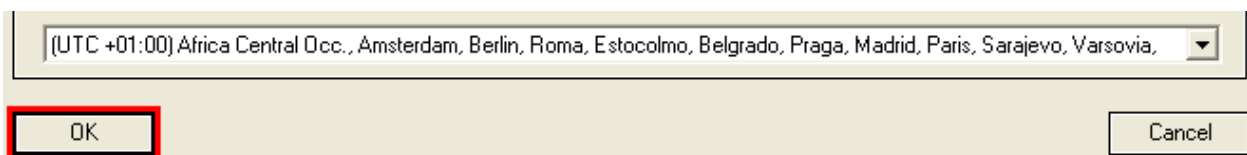

Once the user is in the principal screen, must click “*Write*” in order to write in the device the time set by the user.

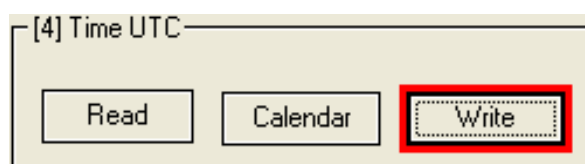

The time that is sent appears in the line of the text.

```
(COM). Scanning for device.....  
Scanning... NPeri: 1, COM: COM1, Baudrate 9600  
Scanning... NPeri: 1, COM: COM1, Baudrate 19200  
Scanning... NPeri: 1, COM: COM1, Baudrate 38400  
(COM). Scanning End.  
open COM1  
Info: TIME UTC Read: 02/10/2009 10:37:16  
Info: TIME UTC Read: 02/10/2009 11:05:43  
Info: TIME UTC Write: 02/10/2009 11:00:00  
Info: TIME UTC Read: 02/10/2009 11:00:34  
Info: TIME UTC Write: 02/10/2009 14:00:00  
Info: TIME UTC Write: 02/10/2009 11:05:00
```

14.- CE CERTIFICATE

DECLARACION DE CONFORMIDAD CE
CE DECLARATION OF CONFORMITY
DECLARATION DE CONFORMITE CE

Por la presente **CIRCUTOR, S.A.**
We hereby
Par le présent

Con dirección en: **Vial Sant Jordi, s/n**
With address in: **08232 VILADECALLS (Barcelona)**
Avec adresse à: **ESPAÑA**

Declaramos bajo nuestra responsabilidad que el producto:
We declare under our responsibility that the product:
Nous déclarons sous notre responsabilité que le produit:

**Equipo portátil para auditorías
energéticas**

Serie: CIR-e3

Marca CIRCUTOR

Siempre que sea instalado, mantenido y usado en la aplicación para la que ha sido fabricado, de acuerdo con las normas de instalación aplicables y las instrucciones del fabricante,
Provided that it is installed, maintained and used in application for which it was made, in accordance with relevant installation standards and manufacturer's instructions,
Toujours qu'il soit installé, maintenu et utilisé pour l'application par laquelle il a été fabriqué, d'accord avec les normes d'installation applicables et suivant les instructions du fabricant,

Cumple con las prescripciones de la(s) Directiva(s):
Complies with the provisions of Directive(s):
Accomplie avec les prescriptions de la (les) Directive(s):

**2006/95/CE
2004/108/CE
98/37/CE**

Está en conformidad con la(s) siguiente(s) norma(s) u otro(s) documento(s) normativo(s) :
It is in conformity with the following standard(s) or other normative document(s) :
Il est en conformité avec la (les) norme(s) suivante(s) ou autre(s) document(s) normatif (ves) :

IEC 60664-1	IEC 61000-6-2
IEC 61010-1	IEC 61000-4-3
IEC 62053-21	IEC 61000-4-4
IEC 61000-3-2	IEC 61000-4-5
IEC 61000-3-3	IEC 61000-4-8
IEC 61000-6-4	IEC 61000-6-1
EN 55011	IEC 61000-4-11
EN 55022	IEC 60529
UL 94	ENV 50141
VDE 110	

Año de colocación del marcado "CE": 2009
Year of affixing "CE" marking:
An de mise en application du marquage "CE":

Revisado en Viladecavalls
Fecha: 26/02/2009

Nombre y Firma :
Name and signature :
Nom et signature :

