



DIGITAL PANEL METER N30U TYPE



USER'S MANUAL



Contents

1. APPLICATION AND METER DESIGN	5
2. METER SET.....	6
3. BASIC REQUIREMENTS, OPERATIONAL SAFETY	7
4. INSTALLATION.....	7
5. SERVICE	11
6. RS-485 INTERFACE	27
7. ERROR CODES	41
8. TECHNICAL DATA	42
9. ORDER CODES	42
10. MAINTENANCE AND GUARANTEE.....	44

1. APPLICATION AND METER DESIGN

The N30U meter is a programmable digital panel meter destined for measurements of signals originating from standard sensors destined for temperature measurements and for the measurement of analog standard signals applied in automation. Additionally, the meter enables the indication of the current time. The readout field is a LED display, which allows the exposition of results in colours: red, green and orange. The measured input signal can be arbitrary converted by means of a 21-point individual characteristic.

Features of the N30U meter:

- display colour individually programmed in three intervals,
- programmable thresholds of displayed overflows,
- 2 NOC relay alarms operating in 6 modes,
- 2 switched relay alarms with a switching contact operating in 6 modes (option),
- signaling of measuring range overflow,
- automatic setting of the decimal point,
- programming of alarm and analog outputs with the reaction on the selected input quantity (main or auxiliary input),
- real-time clock with the function of the clock supply support in case of the meter supply decay,
- programmed averaging time – function of walking window with the averaging time up to 1 hour,
- monitoring of set parameter values,
- locking of introduced parameters by means of a password,
- recount of the measured quantity on the base of the 21-point individual characteristic,
- service of the interface with MODBUS protocol in the RTU mode (option),
- conversion of the measured value into a standard – programmable current or voltage signal (option),
- highlight of any measuring unit acc. to the order,

- signaling of alarm operation – switching the alarm on causes the highlight of the output number,
- galvanic separation between connections: alarm, supply, input, analog output, output of the auxiliary supply, RS-485 interface.

Protection grade from frontal side: IP65

Meter overall dimensions: 96 x 48 x 93 mm (with terminals).

The meter casing is made of plastic.



Fig. 1 View of the N30U Digital Meter

2. METER SET

The set is composed of:

- N30U meter 1 pc
- User's manual 1 pc
- Guarantee card 1 pc
- Set of clamps to fix the meter in the panel 4 pcs
- Set of labels with units 2 pcs
- Seal 1 pc

When unpacking the meter, please check whether the type and execution code on the data plate correspond to the order.

3. BASIC REQUIREMENTS, OPTIONAL SAFETY

In the safety service scope, the N30U meter meets the requirements of the EN 61010-1 standard.

Mentioned below applied symbols mean:



- especially important, one must acquaint with this information before connecting the meter. The non-observance of notices marked by this symbol can occasion injuries of the personnel and a damage of the instrument.



- One must take note of this when the instrument is working inconsistently to the expectations. Possible consequences if disregarded.

Observations concerning the operational safety



- All operations concerning transport, installation, and commissioning as well as maintenance, must be carried out by qualified, skilled personnel, and national regulations for the prevention of accidents must be observed.
- Before switching the meter on, one must check the correctness of connections.
- Do not connect the meter to the network through an autotransformer.
- Before removing the meter housing, one must switch the supply off and disconnect measuring circuits.
- The meter is designed to be installed and exploited in electromagnetic industrial environment conditions.
- When connecting the supply, one must remember that a switch or a circuit-breaker should be installed in the building. This switch should be located near the device, easy accessible by the operator, and suitably marked as an element switching the meter off.
- Non-authorized removal of the housing, inappropriate use, incorrect installation or operation, creates the risk of injury to personnel or meter damage. For more detailed information, please study the User's Manual.

4. INSTALLATION

The meter has separable strips with screw terminals, which enable the connection of external wires of 1.5 mm^2 cross-section for input signals and 2.5 mm^2 for other signals.

One must prepare a hole of $92^{+0.6} \times 45^{+0.6} \text{ mm}$ in the panel, which the thickness should not exceed 6 mm.

The meter is adapted to be mounted in a panel. The meter must be introduced from the panel front with disconnected supply voltage. Before the insertion into the panel, one must check the correct placement of the seal. After the insertion into the hole, fix the meter by means of clamps (fig.2).

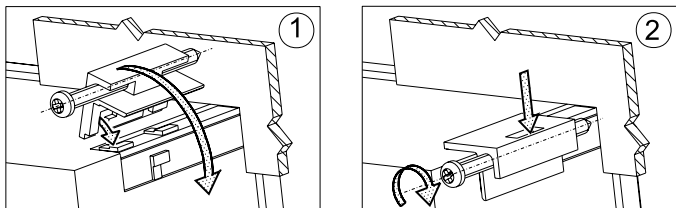

Fig. 2. Meter Fixing

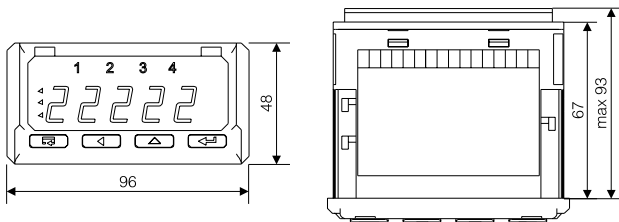

Fig. 3. Overall Dimensions

4.1. Lead-out of Signals

Signals led out on the meter connectors are presented on the fig. 4. Circuits of successive groups of signals are separated between them.

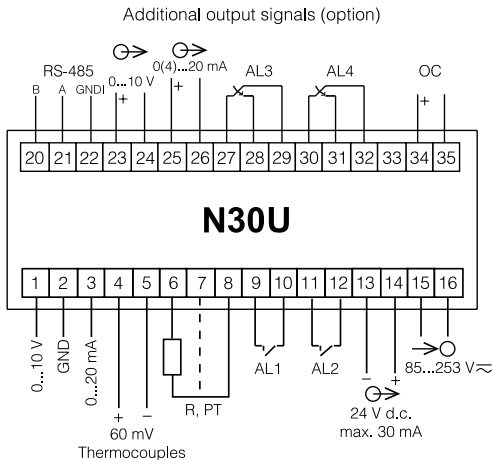

Fig. 4. Description of Signals on Connection Strips

- 0...10 V – input for the measurement ± 10 V voltage,
- GND – mass for the 0...10 V input and 0...20 mA input,
- 0...20 mA – input for the measurement of ± 20 mA current,
- 60 mV TC – input for the measurement of 60 mV voltage, or for the connection of RTD sensors,
- R, PT – input for the resistance measurement or for the connection of RTD sensors. The compensation wire has been marked by a broken line,
- OC – open collector output of npn type– signaling of the measuring range overflow.

4.2. Examples of Connections

An example of the N30U meter connection to different signals is presented on the fig. 5.

Standard signals:

0...10 V and 0...20 mA

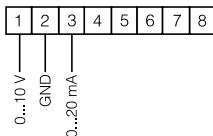

Thermocouple

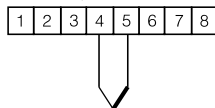

Voltage 0...60 mV

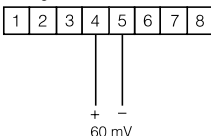

Resistor, RTD sensor
in a two-wire system

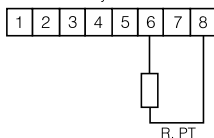

Resistor, RTD sensor
in a three-wire system

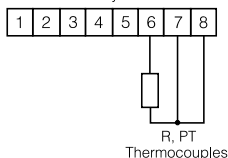

Connection of a two-wire
transducer (4...20 mA)

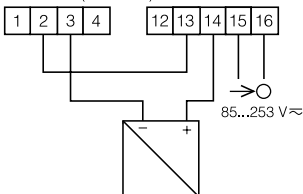

Connection of a three-wire
transducer (0...10 V)

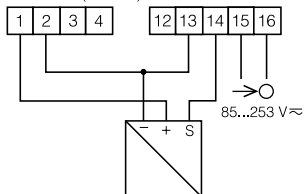

Fig. 5. Ways of the meter Connection

For the connection of input signals in environments with a high noise level, one must apply shielded wires.

5. SERVICE

5.1. Display Description

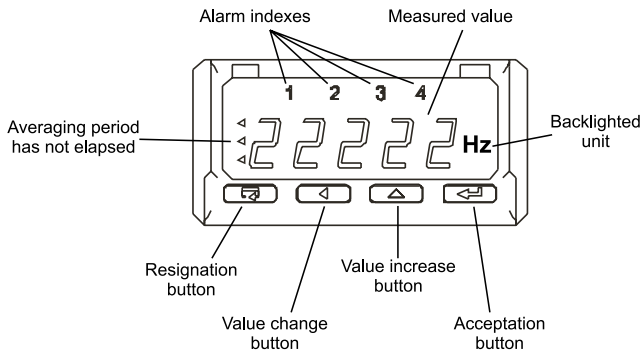

Fig. 6. Description of the Meter Frontal Plate

5.2. Messages after Switching the Supply on

After switching the supply on, the meter displays the meter name N30U and next the program version in the „r x.xx” shape – where x.xx is the number of the current program version or the number of a custom-made execution. Next, the meter carries out measurements and displays the value of the input signal. The meter sets up automatically the decimal point position when displaying the value. The format (number of places after the decimal point) can be limited by the user.

5.3. Functions of Buttons



- **Acceptation button:**

- ⇒ entry in programming mode (hold down ca 3 seconds)
- ⇒ moving through the menu – choice of level,
- ⇒ entry in the mode changing the parameter value,
- ⇒ acceptance of the changed parameter value,
- ⇒ stop the measurement – when holding down the button, the result is not updated. The measurement is still carried out.



- **button increasing the value:**

- ⇒ display of maximal value, The pressure of the button causes the display of the maximal value during ca 3 seconds.
- ⇒ entry in the level of the parameter group,
- ⇒ moving through the chosen level,
- ⇒ change of the chosen parameter value – increasing the value.





- **Button to change the digit:**



- ⇒ display of minimal value, The pressure of the button causes the display of the maximal value during ca 3 seconds.
- ⇒ entry in the level of parameter group,
- ⇒ moving through the chosen level,
- ⇒ change of chosen parameter value – shift on the next digit,



- **resignation button:**





- ⇒ entry in the menu monitoring the meter parameters (by holding down ca 3 seconds),
- ⇒ exit from the menu monitoring meter parameters,
- ⇒ resignation of the parameter change,
- ⇒ absolute exit from the programming mode (by holding down ca 3 seconds).

The pressure of the   button combination and holding them down ca 3 seconds, causes the reset of alarm signaling. This operation acts only when the support function is switched on.

The pressure of the   button combination causes the erasing of the minimal value.

The pressure of the   button combination causes the erasing of the maximal value.

The pressure and holding down the  button ca 3 seconds causes the entry in the programming matrix. The programming matrix can be protected by the safety code.

The pressure and holding down the  button during 3 seconds causes the entry in the menu monitoring meter parameters. One must move through the monitoring menu by means of  and  buttons. In this menu, all programmable meter parameters are only available for readout. In this mode, the menu **Ser** is not available. The exit from the monitoring menu is carried out by means of the  button. In the monitoring menu, parameter symbols are displayed alternately with their values.

The service algorithm of the meter is presented on the fig. 7.

Pojawienie się na wyświetlaczach cyfrowych niżej wymienionych symboli oznacza:

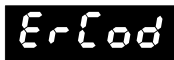

- Niepoprawnie wprowadzony kod bezpieczeństwa.



- Przekroczenie górnego zakresu pomiarowego lub wartość nie mieści się na wyświetlaczu (wartość za duża). Pojawienie się komunikatu może świadczyć również o przerwie w obwodzie czujnika.



- Przekroczenie dolnego zakresu pomiarowego lub wartość nie mieści się na wyświetlaczu (wartość za mała). Pojawienie się komunikatu może świadczyć o przerwie w obwodzie czujnika.

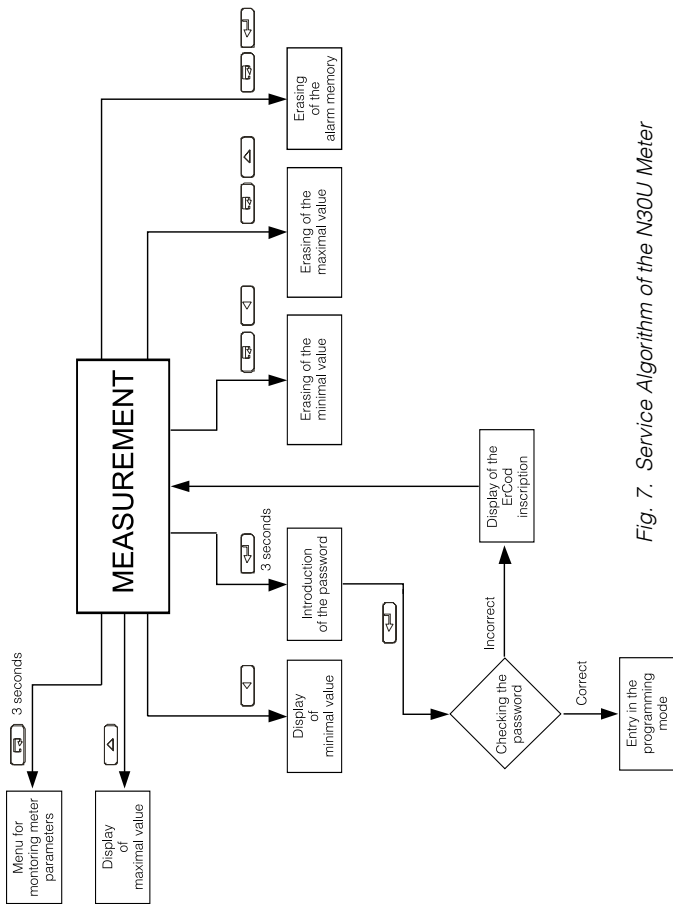













Fig. 7. Service Algorithm of the N30U Meter

5.4. Programming

The pressure of the  button and holding it down through ca 3 seconds causes the entry to the programming matrix. If the entry is protected by a password, then the safety code symbol **SEC** is displayed alternately with the set value **0**. The write of the correct code causes the entry in the matrix, the write of an incorrect code causes the display of the **ErCod** symbol. The matrix of transitions to the programming mode is presented on the fig. 8. The choice of the level is made by means of the  button, however the entry and moving through the parameters of the chosen level is carried out by means of the  and  buttons. Parameter symbols are displayed alternately with their current values. In order to change the value of the chosen parameter, one must use the  button. For resignation from change, one must use the  button. In order to exit from the chosen level, one must chose the ---- symbol and press the  button. To exit from the programming matrix, one must press the  button during ca 1 second. Then, the symbol **End** appears for ca 3 seconds and the meter transits to the display of the measured value. In case of leaving the meter in the parameter programming mode, the automatic abandon of the programming mode follows (parameter, and next the menu) after 30 seconds and the meter transits to display the measured value.

5.4.1. Value Change Way of the Selected Parameter



In order to increase the value of the selected parameter, one must press the  button. A single pressure of the button, causes the increase of the value of 1. The increase of value when displaying the digit 9 causes the set of 0 on this digit. The change of the digit follows after pressing the  button. In order to accept the set parameter, one must hold down the  button. Then, the write of the parameter follows and the display of its symbol, alternately with the new value. The pressure of the  button during the change of the parameter value will cause the resignation of the write.

Item	Inp1 Parameters of main input	tYP1 Type of measured quantity	Con Kind of compensation	Cnt1 Measurement time	-----		
1							
2	Ind Parameters of individ. charact.	IndCp Number of points of individ. charact.	H1 First point of the individ. charact. Point x.	Y First point of the individ. charact. Point y.	...	H21 Last point of the characteristic	Y21 Last point of the characteristic
3	dISP Display Parameters	d_P Minimal decimal point	Coldo Lower colour	Colbe Middle colour	Collup Upper colour	ColLo Lower threshold of colour change	ColHi Upper threshold of colour change
4	ALr1 Alarm 1	P_A1 Type of input quantity for alarm 1	PrL1 Lower threshold	PrH1 Upper threshold	tYP1 Alarm type	dLY1 Alarm delay	LED1 Signaling support
5	ALr2 Alarm 2	P_A2 Type of input quantity for alarm 1	PrL2 Lower threshold	PrH2 Upper threshold	tYP2 Alarm type	dLY2 Alarm delay	LED2 Signaling support
6	ALr3 Alarm 3	P_A3 Type of input quantity for alarm 1	PrL3 Lower threshold	PrH3 Upper threshold	tYP3 Alarm type	dLY3 Alarm delay	LED3 Signaling support
7	ALr4 Alarm 4	P_A4 Type of input quantity for alarm 2	PrL4 Lower threshold	PrH4 Upper threshold	tYP4 Alarm type	dLY4 Alarm delay	LED4 Signaling support
8	Out Outputs	P_An Type of quantity of the analog output	AnL Lower threshold of the analog output	AnH Upper threshold of the analog output	typ_A Kind of output (volt/curr)	bAud Baud rate	prot Kind of frame
9	SEr Service	Set Write the standard parameters	SEC Introduction of the password	Hour Setup of the time	unit Highlight the unit	tEST Display test	addr Device address
					-----		ovrHi Upper overflow

Fig. 8. Programming Matrix.

5.4.2. Changing Floating-Point Values

The change is carried out in two stages (the transition to the next stage follows after pressing the  button):

- 1) setting the value from the range -19999M...99999, similarly as for integral values;
- 2) setting of the decimal point position (00000., 0000.0, 000.00, 00.000, 0.0000); the  button shifts the decimal point to the left, however the  button shifts the decimal point to the right;

The pressure of the  button during the change of the parameter value will cause the resignation of the write.

5.4.3. Characteristic of Programmed Parameters

Programmed parameters and the range of their quantity changes are presented in the table below.

Table 1

InP 1		
Parameter symbol	Description	Range of changes
tYP1	Kind of the connected input signal	Pt1 – Pt100 Pt5 – Pt500 Pt10 – Pt1000 rEzL – measurement of resistance up to 400 Ω rEzH – measurement of resistance up to 4000 Ω tE-J – J (Fe-CuNi) tE-h – K (NiCr-NiAl) tE-n – N (NiCrSi-NiSi) tE-E – E (NiCr-CuNi) tE-r – R (PtRh13-Pt) tE-S – S (PtRh10-Pt) O_10U – voltage measurement, range 10 V. O_20A – current measurement, range 20mA O_60n – voltage measurement, range 60mV. HOuR – current time.

Con	Choice of the measured value compensation. Concerns only the work in the mode of temperature or resistance measurement. The wire linking the meter with the sensor defines the resistance for RTD sensors, however for thermocouples, the compensation is defined by the cold junction temperature. The choice of a value beyond the range causes the switching of the automatic compensation off.	-19999...99999 Introduction of values: 0..20 Ω - causes the switching of the manual compensation on for the resistance or temperature measurement by means of RTD (resistance thermometers). 0...60°C – causes the switching of the manual compensation on for thermocouples.
Cnt1	The measurement time is expressed in seconds. The result on the display presents the mean value counted in the Cnt1 period. This parameter is not taken into consideration during the measurement in counter modes.	1...3600

Table 2

Ind		
Parameter symbol	Description	Range of changes
IndCp	Number of points of the individual characteristic. For a value lower than 2, the individual characteristic is switched off. The number of segments is the number of points decreased of one. The individual characteristic is not taken into consideration in the CountH and HoUr modes.	1...21
Hn	The point value for which we will expect Yn (n-point number)	-19999...99999
Yn	Expected value for Xn.	-19999...99999

Table 3



dISP		
Parameter symbol	Description	Range of changes
d_P	Minimal position of the decimal point When displaying the measured value - display format. This parameter is not taken into consideration during tCountH and HoUr modes.	0.0000 – 0 00.000 – 1 000.00 – 2 0000.0 – 3 00000 – 4
CoLdo	Display colour, when the displayed value is over than CoLLo	rEd – red grEEen – green orAnG - orange
CoLbE	Display colour, when the displayed value is higher than CoLLo and lower than CoLHi	
CoLuP	Display colour when the displayed value is higher than CoLHi	
CoLLo	Lower threshold of colour change	-19999..99999
CoLHi	Upper threshold of colour change	-19999..99999
ovrLo	Lower threshold of display narrowing Values below the declared threshold are signaled on the display by the  symbol.	-19999..99999
ovrHi	Upper threshold of display narrowing Values above the declared threshold are signaled on the display by the  symbol.	-19999..99999

Table 4

ALr1, ALr2, ALr3, ALr4		
Parameter symbol	Description	Range of changes
P_A1 P_A2 P_A3 P_A4	Input quantity, steering the alarm.	InP1 – Main input (indicated value). HoUr – Real-time clock.

tYP1 tYP2 tYP3 tYP4	Alarm type. Fig. 11 presents the graphical imaging of alarm types	n-on – normal (transition from 0 na 1), n-oFF – normal (transition from 1 na 0), on - switched on, oFF – switched off, H-on – manually switched on; till the change time of the alarm type, the alarm output remains switched on H-oFF – manually switched off; till the change time of the alarm type the output alarm remains switched off for good.
PrL1 PrL2 PrL3 PrL4	Lower alarm threshold.	-19999...99999
PrH1 PrH2 PrH3 PrH4	Upper alarm threshold.	-19999...99999
dLY1 dLY2 dLY3 dLY4	Delay of alarm switching.	-19999...99999



LEd1 LEd2 LEd3 LEd4	<p>Support of alarm signaling. In the situation when the support function is switched on, After the alarm state retrea, the signaling diode is not blanked. It signals the alarm state till its blanking moment by means of the   button combination. This function concerns only and exclusively the alarm signaling thus relay contacts will operate without support according to the chosen type of alarm.</p>	oFF – function switched off oN – function switched on
--	---	--

Table 5

out		
Parameter symbol	Description	Range of changes
P_An	Input quantity, which the analog output has to react on.	InP1 – main input (indicated value). Hour – real-time clock.
tyPA	Type of analog output	0_10U – voltage 0...10 V 0_20A – current 0...20 mA 4_20A – current 4...20 mA
AnL	Lower threshold of the analog output. give the value, on which we want to obtain the minimal value of signal on the analog output.	-19999...99999
AnH	Upper threshold of the analog output. give the value on which we want to obtain the maximal value of signal on the analog output(10 V or 20 mA).	-19999...99999

bAud	Baud rate of the RS485 interface	4.8 – 4800 bit/s 9.6 – 9600 bit/s 19.2 – 19200 bit/s 38.4 – 38400 bit/s 57.6 – 57600 bit/s 115.2 – 115200 bit/s
prot	Type of transmission frame of the RS-485 interface.	r8n2 r8E1 r8o1 r8n1
Addr	Address in the MODBUS network. The write of the value 0 switches the interface off.	0...247

Table 6

SEr		
Parameter symbol	Description	Range of changes
SEt	Write of manufacturer's settings. The setting of the value YES causes the write of standard parameters into the meter. The value of manufacturer's parameters is presented in the table 7.	no – do nothing. Yes – causes the write of manufacturer's settings.
SEC	Introduction of a new password. The introduction of the value 0 switches the password off.	0...60000
HOUR	Setting of the current time. The introduction of a wrong time cancels the introduction of time. The introduced value is not taken.	0,00...23,59
unlt	Highlight of the unit.	On – unit highlight switched on. Off – unit highlight switched off.

<p>tEst</p>	<p>Display test. The test consists in a successive lighting up of digital display segments. Alarm diodes and unit highlighting diodes should be lighted.</p>	<p>Yes – causes the test start The pressure of the  button ends the test. no – do nothing.</p>
--------------------	--	---

5.4.4 Individual Characteristic

N30U meters can recalculate the measured value into any value thanks to the implemented individual characteristic function. The individual characteristic rescales the input signal measured according to the set characteristic. The way of the individual characteristic interaction on the meter operation has been presented on the fig. 9.

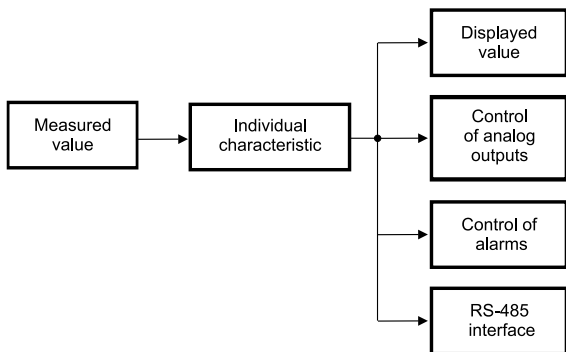
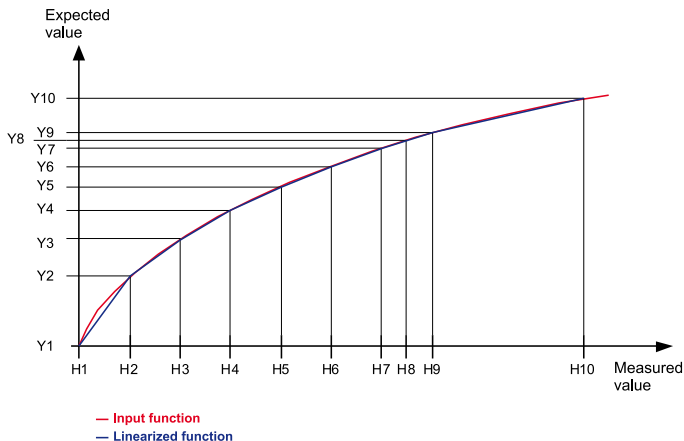

Fig. 9. Action of the Individual Characteristic.

The user can introduce maximally twenty functions through giving intervals and expected values for successive points.

The programming of the individual characteristic consists on the definition of the number of points which the input function will be linearized by. One must remember that the number of linearizing functions is of one

smaller than the number of points. Next, one must program successive points by giving the measured value (H_n) and the expected value corresponding to it, – value which has to be displayed (Y_n). The graphic interpretation of the individual characteristic is presented on the fig. 10.



Rys. 10. Individual Characteristic.

During the function approximation, one must remember that for the approximation of functions strongly differing from the linear characteristic, higher the number of linearizing segments, smaller the error related to the linearization.

If measured values are smaller than H_1 , recalculations will be made on the base of the first straight line calculated on the base of points (H_1, Y_1) and (H_2, Y_2). However, for values higher than H_n (where n – the last declared measured value) the value to display will be calculated on the base of the last assigned linear function.

Note: All introduced points of the measured value (H_n) must be arranged

ged in the increasing sequence, such to preserve the following dependence:

$$H1 < H2 < H3 \dots < Hn$$

If the above is not fulfilled, the individual characteristic function will be automatically switched off (will not be realized) and a diagnostic flag will be set in the status register.

5.4.5 Alarm types

The N30U meter is equipped with 2 alarm outputs with NOC contact (make contact) and two alarm outputs with NOC/NCC contact (make and break contact) (option). Each of alarms can work in one of the six modes. The work of alarms in modes is presented in the fig. 12: n-on, n-off, on, off. Two remaining modes: h-on and h-off mean suitably, always switched on and always switched off. These modes are destined for the manual simulation of alarm states.

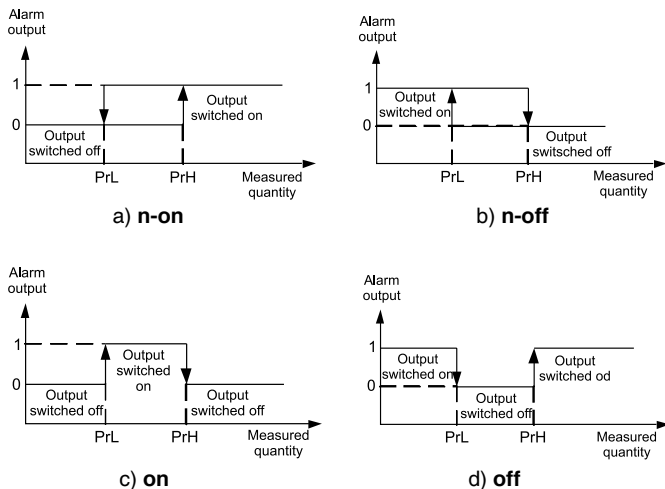

Fig. 11. Alarm Types: a) n-on, b) n-off c) on d) off.



Caution !

- In case of alarms of n-on, n-off, on, off types the write of PrL>PrH will cause the alarm switching off.
- In case of a measuring range overflow, the reaction of the relays is compatible with written PrL, PrH, tYP parameters. In spite of the displayed overflow, the meter still carries out the measurement.
- The meter controls currently the value of the introduced parameter at the moment. In case when the introduced value overflows the upper range given in the table 1, the meter will make automatically the change into the maximal value. Similarly, in case when the introduced value overflows the lower change range given in the table 1, the meter will make automatically the change into the minimal value.

5.4.6 Display Format

The N30U meter adapts automatically the display format (precision) to the value of measured quantity. So that the function could be fully used, one must choose the format **0.0000**, then the meter will display the measured value with the possible highest accuracy. This function does not operate for the time display, where the format is set automatically. The current time (mode HOUr) is displayed in the 24 hours' format, in the shape hh.mm, where hh – current hour, and mm – current minute.

Caution: Remember that the display with a higher resolution is not always desired, it can conduct to a deterioration of the indication stability.

5.5. Manufacturer's Parameters

Standard settings of the N30U meter are presented in the table 7.

These settings can be restored by means of the meter menu through the choice of the option **Set** from the menu **Ser**.

Table 7

Parametru symbol	Level in the matrix	Standard value
tYP1	1	Pt1
Con	1	0
Cnt1	1	1
indCP	2	no
H0	2	0
Y0	2	0
H1	2	100
Y1	2	100
...
Hn	2	$(n-1)*100$
Yn	2	$(n-1)*100$
d_P	3	00000
CoLdo	3	grEEEn
CoLbE	3	orAng
CoLuP	3	rEd
CoLLo	3	5000
CoLHi	3	8000
ovrLo	3	-19999
ovrHi	3	99999
P_A1, P_A2, P_A3, P_A4	4, 5, 6, 7	lnP1
tYP1, tYP2, tYP3, tYP4	4, 5, 6, 7	h-off
PrL1, PrL2, PrL3, PrL4	4, 5, 6, 7	1000

PrH1, PrH2, PrH3, PrH4	4, 5, 6, 7	2000
dLY1, dLY2, dLY3, dLY4,	4, 5, 6, 7	0
LEd1, LEd2, LEd3, LEd4	4, 5, 6, 7	oFF
P_An	8	InP1
tYPA	8	0_10U
AnL	8	0
AnH	8	99999
bAud	8	9.6
prot	8	r8n2
Addr	8	1
SEt	9	no
SEC	9	0
HOUR	9	Not defined
unit	9	off
tEst	9	off

6. INTERFACE RS-485

N30U programmable digital meters have serial links in RS-485 standards for the communication in computer systems and with other devices fulfilling Master function. An asynchronous communication character protocol MODBUS has been implemented on the serial link. The transmission protocol describes ways of information between devices through the serial link.

6.1. Connection Way of the Serial Interface

The RS-485 standard allows to a direct communication of 32 devices on a single serial link of 1200 m long (at baud rate 9600 b/s). For the

connection of a higher quantity of devices, it is necessary to apply additional intermediate-separating systems (e.g. PD51 converter).

The lead out interface line is presented on the fig. 4. To obtain a correct transmission, it is necessary to connect lines A and B in parallel with their equivalents in other devices. The connection must be made through a shielded wire. The wire shield must be connected to the protection terminal in the nearest possible neighbourhood of the meter (connect the shield only in a single point to the protection terminal).

The GND line serves to the additional protection of the interface line at long connections. Then, one must connect GND signals of all devices on the RS-485 bus.

To obtain the connection to the computer, a RS-485 interface card or a suitable converter is indispensable, e.g. PD51 or PD10.

The connection way of devices is shown on the fig. 12

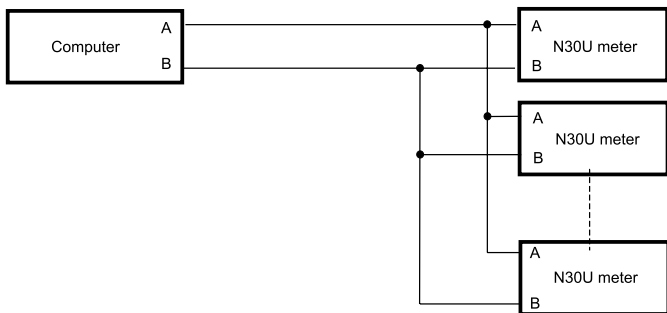

Fig. 12. Connection Way of the RS-485 interface

The designation of transmission lines for the card in the PC computer depends on the card producer.

6.2. Description of the MODBUS Protocol Implementation

The implemented protocol is in accordance with the PI-MBUS-300 Rev G of Modicon Company specification.

Set of the serial link parameters of N30U meters in MODBUS protocol:

- meter address: 1...247,
- baud rate: 4800, 9600, 19200, 38400, 57600, 115200 bit/s,
- work mode: RTU z ramką w formacie 8n2, 8e1, 8o1, 8n1,
- maximal response time: 100 ms.

The parameter configuration of the serial link consists in the settlement of the baud rate (**bAUd** parameter), device address (**Addr** parameter), and the format of the information unit (prot parameter)

Notice: Each meter connected to the communication network must have:

- unique address, different from addresses of other devices connected to the network,
- identical baud rate and type of information unit.

6.3 Description of Applied Functions

Following MODBUS functions have been implemented in the N30U meter:

- 03 – readout of the register group.
- 16 – write of the register group.
- 17 – identification of the slave device.

6.4 Mapa rejestrów

The register map of the N30U meter is presented below

Notice:

All given addresses are physical addresses. In some computer programs logic addressing is applied, then addresses must be increased of 1.

Table 8

Range of address	Value type	Description
4000-4049	integer (16 bits)	Value placed in a 16-bit register.
7000-7039	float (32 bits)	Value placed in two successive 16-bit registers. Registers include the same data as 32-bit register from the area 7500. Registers are only for readout.
7200-7326	float (32 bits)	Value placed in two successive 16-bit registers. Registers include the same data as 32-bit register from the area 7600. Registers can be read out and written.
7500-7519	float (32 bits)	Value placed in a 32-bit register. Registers are only for readout.
7600-7663	float (32 bits)	Value placed in a 32-bit register. Registers can be read out and written.

6.5. Registers for Write and Readout

Table 9

The value is placed in 16-bit registers	Symbol	write (w)/readout (r)	Range	Description
4000	tYP1	w/r	0...14	Input type
				Value
				0 Pt1 – Pt100
				1 Pt5 – Pt500
				2 Pt10 – Pt1000
				3 rEZL – Resistance, range 400 Ω
				4 rEZL – Resistance, range 4000 Ω
				5 tE-J – J – thermocouple of J type
				6 tE-h – K – thermocouple of K type
				7 tE-n – N – thermocouple of N type
				8 tE-E – E – thermocouple of E type
				9 tE-r – R – thermocouple of R type
				10 tE-S – S – thermocouple of S type
				11 0_10U – voltage measurement, range 10 V
				12 0_20A – current measurement, range 20 mA
				13 0_60n – voltage measurement, range 60 mV
				14 HoUr – current time
4001		w/r		Reserved
4002		w/r		Reserved
4003	Cnt	w/r	1...3600	Measurement time expressed in seconds. This time defines the averaging time of the measured value. The displayed value is the mean value calculated from the Cnt1 period.
4004		w/r		Reserved
4005		w/r		Reserved
4006		w/r		Reserved
4007		w/r		Reserved

4008	IndCp	w/r	1...21	Number of points of the individual characteristic. For the value 1, the individual characteristic is switched off. Segments of the individual characteristic are defined by parameters Xn and Yn, where n – point number.	
4009	d_P	w/r	0...4	Minimal position of the decimal point when displaying the measured value.	
				Value	Description
				0	0.0000
				1	00.000
				2	000.00
				3	0000.0
4	00000				
4010	CoLdo	w/r	0...2	Display colour when the displayed value is smaller than coLLo	
				Value	Description
				0	red
				1	green
2	orange				
4011	CoLbE	w/r	0...2	Display colour when the displayed value is higher than coLLo and smaller than coLHi	
				Value	Description
				0	red
				1	green
2	orange				
4012	CoLUp	w/r	0...2	Display colour when the displayed value is higher than coLHi	
				Value	Description
				0	red
				1	green
2	orange				
4013	P_a1	w/r	0, 1	Input quantity controlling the alarm	
				Value	Description
				0	Main input
				1	clock

4014	tyP1	w/r	0...5	Type of alarm 1 (description – fig. 6)	
				Value	Description
				0	n-on
				1	n-off
				2	on
				3	off
				4	h-on
5	h-off				
4015	dLY1	w/r	0...120	Delay of alarm 1 (in seconds)	
4016	LEd1	w/r	0...1	Support of alarm 1 signaling	
				Value	Description
				0	Support switched off
				1	Support switched on
4017	P_a2	w/r	0, 1	Input quantity controlling the alarm	
				Value	Description
				0	Main input
				1	clock
4018	tyP2	w/r	0...5	Type of alarm 2 (description – fig. 6)	
				Value	Description
				0	n-on
				1	n-off
				2	on
				3	off
				4	h-on
5	h-off				
4019	dLY2	w/r	0...120	Delay of alarm 2 (in seconds)	
4020	LEd2	w/r	0...1	Support of alarm 2 signaling	
				Value	Description
				0	Support switched off
				1	Support switched on
4021	P_a3	w/r	0, 1	Input quantity controlling the alarm	
				Value	Description
				0	Main input
				1	clock

4022	tyP3	w/r	0...5	Type of alarm 3 (description – fig. 6)	
				Value	Description
				0	n-on
				1	n-off
				2	on
				3	off
				4	h-on
4023	dLY3	w/r	0...120	Delay of alarm 3 (in seconds)	
4024	LEd3	w/r	0...1	Support of alarm 3 signaling	
				Value	Description
				0	Support switched off
				1	Support switched on
4025	P_a4	w/r	0, 1	Input quantity controlling the alarm	
				Value	Description
				0	Main input
				1	clock
4026	tyP4	w/r	0...5	Type of alarm 4 (description – fig. 6)	
				Value	Description
				0	n-on
				1	n-off
				2	on
				3	off
				4	h-on
4027	dLY4	w/r	0...120	Delay of alarm 4 (in seconds)	
4028	LEd4	w/r	0...1	Support of alarm 4 signaling	
				Value	Description
				0	Support switched off
				1	Support switched on
4029	P_an	w/r	0, 1	Input quantity, which the analog output has to react on.	
				Value	Description
				0	Main input
				1	clock

4030	tYPa	w/r	0...2	Type of analog output	
				Value	Description
				0	voltage input 0...10 V
				1	current input 0...20 mA
				2	current input 4...20 mA
4031	bAud	w/r	0...5	Baud rate	
				Value	Description
				0	4800 bit/s
				1	9600 bit/s
				2	19200 bit/s
				3	38400 bit/s
				4	57600 bit/s
5	115200 bit/s				
4032	prot	w/r	0...3	Transmission mode	
				value	Description
				0	RTU 8N2
				1	RTU 8E1
				2	RTU 8O1
3	RTU 8N1				
4033	Addr	w/r	0...247	Meter address. The write of the value 0 causes the interface switching off	
4034	sAvE	w/r	0...1	Update transmission parameters. Causes the application of introduced RS-485 interface settings.	
4035	SEt	w/r	0...1	Write of standard parameters	
				Value	Description
				0	without changes
				1	set standard parameters
4036	SEc	w/r	0...6000	Password for parameters	
				Value	Description
				0	without password
				...	Entry in parameters preceded by a request about the password
4037	hour	w/r	0...2359	Current time	
				<p>This parameter occurs in the ggmm format, where: gg - means hours, mm – means minutes. The introduction of a wrong hour will cause the setting of 23, however the introduction of wrong minutes will generate the setting of the value 59.</p>	

4038	unit	w/r	0, 1	Switch on/off the unit highlight	
				Value	Description
				0	highlight switched off
				1	highlight switched on
...	Reserved	
4048	Status1	w/r	0...65535	Meter status. Describes the current state of the meter. Successive bits represent the given event. The bit set on 1 means, that the event took place. Events can be only erased.	
				Bit 15	Break of the supply
				Bit 14	Re-set of the RTC clock
				Bit 13	Not used
				Bit 12	Lack of communication with data memory
				Bit 11	Wrong settings
				Bit 10	Manufacturer' s setting restored
				Bit 9	Lack of measured values in data memory
				Bit 8	Not used
				Bit 7	Output plate is detected
				Bit 6	Output plate – error or lack of calibration
				Bit 5	Not used
				Bit 4	Not used
				Bit 3	Wrong configuration of the individual characteristic
				Bit 2	Not used
Bit 1	Not used				
Bit 0	Averaging period is not elapsed				
4049	Status2	w/r		Meter status. Describes the current state of the meter. Successive bits represent the given event. The bit set on 1 means, that the event took place. Events can be only cancelled.	
				Bit 15	Not used
				Bit 14	Not used
				Bit 13	Not used
				Bit 12	Not used
				Bit 11	Not used
				Bit 10	Not used
				Bit 9	Not used
Bit 8	Not used				

4049	Status2	z/o	Bit 7	LED4 – Signaling of alarm nr 4.
			Bit 6	LED3 – Signaling of alarm nr 3.
			Bit 5	LED2 – Signaling of alarm nr 2.
			Bit 4	LED1 – Signaling of alarm nr 1.
			Bit 3	Status of the alarm relay nr 4.
			Bit 2	Status of the alarm relay nr 3.
			Bit 1	Status of the alarm relay nr 2.
			Bit 0	Status of the alarm relay nr 1.

Table 10

The value is placed in two successive 16-bit registers. These registers include the same data as 32-bit registers from the area 7600	The value is placed in 32-bit registers	Symbol	write (w) / read-out (r)	Range	Description
7200	7600	CoLLo	w/r	-19999...99999	Lower threshold of the display colour change
7202	7601	CoLHI	w/r	-19999...99999	Upper threshold of the display colour change
7204	7602	ovrLo	w/r	-19999...99999	Lower threshold of the display narrowing
7206	7603	ovrHI	w/r	-19999...99999	Upper threshold of the display narrowing
7208	7604	PRL 1	w/r	-19999...99999	Lower threshold of alarm 1
7210	7605	PrH 1	w/r	-19999...99999	Upper threshold of alarm 1
7212	7606	PRL 2	w/r	-19999...99999	Lower threshold of alarm 2
7214	7607	PrH 2	w/r	-19999...99999	Upper threshold of alarm 2
7216	7608	PRL 3	w/r	-19999...99999	Lower threshold of alarm 3
7218	7609	PrH 3	w/r	-19999...99999	Upper threshold of alarm 3
7220	7610	PRL 4	w/r	-19999...99999	Lower threshold of alarm 4

7222	7611	PrH 4	w/r	-19999...99999	Upper threshold of alarm 4
7224	7612	AnL	w/r	-19999...99999	Lower threshold of analog output
7226	7613	AnH	w/r	-19999...99999	Upper threshold of analog output
7228	7614	Con	w/r	-19999...99999	Reserved
7230	7615		w/r	0...60000	Reserved
7232	7616		w/r	0...60000	Reserved
7234	7617		w/r	-19999...99999	Reserved
7236	7618		w/r	-19999...99999	Reserved
7238	7619		w/r	0...60000	Reserved
7240	7620		w/r	0...60000	Reserved
7242	7621		w/r	-19999...99999	Reserved
7244	7622	H1	w/r	-19999...99999	Point of the individual characteristic. Point nr 1
7246	7623	Y1	w/r	-19999...99999	Expected value for the point nr 1
7248	7624	H2	w/r	-19999...99999	Point of the individual characteristic. Point nr 2
7250	7625	Y2	w/r	-19999...99999	Expected value for the point nr 2
7252	7626	H3	w/r	-19999...99999	Point of the individual characteristic. Point nr 3
7254	7627	Y3	w/r	-19999...99999	Expected value for the point nr 3
7256	7628	H4	w/r	-19999...99999	Point of the individual characteristic. Point nr 4
7258	7629	Y4	w/r	-19999...99999	Expected value for the point nr 4
7260	7630	H5	w/r	-19999...99999	Point of the individual characteristic. Point nr 5
7262	7631	Y5	w/r	-19999...99999	Expected value for the point nr 5
7264	7632	H6	w/r	-19999...99999	Point of the individual characteristic. Point nr 6
7266	7633	Y6	w/r	-19999...99999	Expected value for the point nr 6
7268	7634	H7	w/r	-19999...99999	Point of the individual characteristic. Point nr 7
7270	7635	Y7	w/r	-19999...99999	Expected value for the point nr 7
7272	7636	H8	w/r	-19999...99999	Point of the individual characteristic. Point nr 8
7274	7637	Y8	w/r	-19999...99999	Expected value for the point nr 8
7276	7638	H9	w/r	-19999...99999	Point of the individual characteristic. Point nr 9

7278	7639	Y9	w/r	-19999...99999	Expected value for the point nr 9
7280	7640	H10	w/r	-19999...99999	Point of the individual characteristic. Point nr 10
7282	7641	Y10	w/r	-19999...99999	Expected value for the point nr 10
7284	7642	H11	w/r	-19999...99999	Point of the individual characteristic. Point nr 11
7286	7643	Y11	w/r	-19999...99999	Expected value for the point nr 11
7288	7644	H12	w/r	-19999...99999	Point of the individual characteristic. Point nr 12
7290	7645	Y12	w/r	-19999...99999	Expected value for the point nr 12
7292	7646	H13	w/r	-19999...99999	Point of the individual characteristic. Point nr 13
7294	7647	Y13	w/r	-19999...99999	Expected value for the point nr 13
7296	7648	H14	w/r	-19999...99999	Point of the individual characteristic. Point nr 14
7298	7649	Y14	w/r	-19999...99999	Expected value for the point nr 14
7300	7650	H15	w/r	-19999...99999	Point of the individual characteristic. Point nr 15
7302	7651	Y15	w/r	-19999...99999	Expected value for the point nr 15
7304	7652	H16	w/r	-19999...99999	Point of the individual characteristic. Point nr 16
7306	7653	Y16	w/r	-19999...99999	Expected value for the point nr 16
7308	7654	H17	w/r	-19999...99999	Point of the individual characteristic. Point nr 17
7310	7655	Y17	w/r	-19999...99999	Expected value for the point nr 17
7312	7656	H18	w/r	-19999...99999	Point of the individual characteristic. Point nr 18
7314	7657	Y18	w/r	-19999...99999	Expected value for the point nr 18
7316	7658	H19	w/r	-19999...99999	Point of the individual characteristic. Point nr 19
7318	7659	Y19	w/r	-19999...99999	Expected value for the point nr 19
7320	7660	H20	w/r	-19999...99999	Point of the individual characteristic. Point nr 20
7322	7661	Y20	w/r	-19999...99999	Expected value for the point nr 20
7324	7662	H21	w/r	-19999...99999	Point of the individual characteristic. Point nr 21
7326	7663	Y21	w/r	-19999...99999	Expected value for the point nr 21

6.6. Registers Only for Readout

Table 11

The value placed in two successive 16-bit registers. These registers include the same data as 32-bit registers from the area 7500	The value is placed in 32-bit registers	Name	Write (w) /readout (r)	Unit	Name of the quantity
7000	7500	Identifier	O	—	Constant identifying the device. The value 183 means the N30U meter
7002	7501	Status	O	—	Status is register describing the current state of the meter
7004	7502	Control	O	%	It is a register defining the control of the analog output
7006	7503	Minimum	O	—	Minimal value of the currently displayed value
7008	7504	Maximum	O	—	Maximal value of the currently displayed value
7010	7505	Displayed value	O	—	Currently displayed value
7012	7506	Current time	O	—	Current time
7014	7507	Wire resistance	O	Ω	Password of analog-to-digital transducer
7016	7508	ADC	O	—	Słowo przetwornika analogowo-cyfrowego
7018	7509	Terminal temperature	O	°C	Temperature of terminals – the measurement is only carried out during the temperature measurement by means of thermoelectric sensors or during time measurements

Table 11



7020	7510	Measured value	○		Measured value - not recalculated in relation to the individual characteristic, a.s.l.
7022	7511	EMF	○	μV	EMF measured on meter terminals, when measuring temperature by means of thermocouples.
7024	7512	Resistance	○	Ohm	Resistance measured on the mean line – only for the resistance measurement or when measuring temperature by means of resistance thermometers (RTD)

7. ERROR CODES

After switching the meter to the network or during the work, messages about errors can appear.

Messages about errors and their reasons are presented below.

Table 12

Error message	Description
	Overflow of upper value of the measuring range value or the programmed indication range. The message can also mean a break in the sensor circuit (thermocouples or resistance thermometers).
	Overflow of lower value of the measuring range value or the programmed indication range. The message can also mean a shorting in the sensor circuit (thermocouples or resistance thermometers).
ErFrt	Communication error with the data memory. Contact the service workshop.
ErPar	Parameter error. Wrong configuration data. Manufacturer's settings will be restored after pressing any button.
ErDEF	Default settings have been restored. Press any button to transit to a normal work.
ErFPL	Error of measured values stored by the meter (measured, maximal and minimal values). Press any button to transit to a normal work. After pressing the button during 1 sec, the ErDEF message will be displayed.

ErCAo	Lack of calibration of analog outputs. Press any button to transit to the normal work. Analog outputs will not be serviced. Contact the service workshop.
ErCAL	Error of calibration. The work is stopped – The meter is not in the state to carry out measurements in a correct way. Incorrect checksum of calibration coefficients or lack of calibration.

8. TECHNICAL DATA

Measuring ranges

Table 13

Kind of input	Indication range	Class
Pt100	-205...855°C (-200...850°C)	0.1
Pt500		
Pt1000		
400 Ω	0...410 Ω (0...400 Ω)	
4000 Ω	0...4010 Ω (0...4000 Ω)	
Thermocouple of J type	-220...1210°C (-200...1200°C)	
Thermocouple of K type	-280...1382°C (-270...1370°C)	
Thermocouple of N type	-250...1310°C (-240...1300°C)	
Thermocouple of E type	-280...1010°C (-270...1000°C)	
Thermocouple of R type	-55...1775°C (-50...1770°C)	
Thermocouple of S type	-55...1775°C (-50...1770°C)	
Voltage input 0...10 V	-13...13 V (-10...10 V)	
Current input	-24...24 mA (-20...20 mA)	
Voltage input 60 mV	-10...63 mV (0...60 mV)	
Current time	00.00...23.59	0.5 sec/24 h

Additional error of thermocouple cold junction temperature compensation: 0.1% of measuring range

Additional error of wire resistance compensation: 0.1% of the 400 Ω range

Relay outputs	- relays, NOC voltageless contacts load capacity 250 V~/0.5A~ - relays, switched voltageless contacts load capacity 250 V~/0.5A~ (option)
Analog outputs (option)	- rogrammable, current 0/4..20mA load resistance $\leq 500 \Omega$ - programmable, voltage 0..10V load resistance $\geq 500 \Omega$
Output of auxiliary supply	24 V d.c./30 mA
Alarm output OC (option)	output of OC type, passive npn, 30 V d.c./30 mA.
Serial interface	RS-485 (option)
Transmission protocol	MODBUS RTU
Error of analog output	0.2% of the set range
Protection level ensured by the casing:	
- frontal side	IP65
- terminal side	IP10
Weight	< 0.2 kg
Overall dimensions	96 × 48 × 93 mm (with terminals)
Reference conditions and rated operating conditions:	
- supply voltage	85...253 V d.c./a.c. 40...400Hz or 20...40 V d.c./a.c. 40...400Hz
- ambient temperature	-25... <u>23</u> ...+55°C
- storage temperature	-33...+70°C
- relative air humidity	25...95% (inadmissible condensation of water vapour)
- work position	any

Additional errors:

- from temperature changes: for analog inputs and outputs
50% of the class/10 K

Standards fulfilled by the meter:***Electromagnetic compatibility:***

- noise immunity acc. to EN 61000-6-2
- noise emissions acc. to EN 61000-6-4

Safety requirements:

acc. to EN61010-1 standard:

- isolation between circuits: basic,
- installation category: III,
- pollution level: 2,
- maximal phase-to-earth work voltage:
 - 300 V for the supply circuit and,
 - 50 V for remaining circuits.
- altitude above sea level: < 2000 m.

9. ORDER CODES

Table 14

DIGITAL PANEL METER	N30U -	X	X	XX	XX	X	X
Supply:							
85... 253 V a.c. (45...65 Hz) or d.c.		1					
20... 40 V a.c. (45...65 Hz) or d.c.		2					
Additional outputs:							
lack		0					
OC output, RS485, analog outputs		1					
OCoutput, RS485, analog outputs, switched relay outputs		2					
Unit:							
unit code number acc. tab. 15				XX			
Version:							
standard						00	
custom-made*						XX	
Language:							
Polish							P
English							E
other*							X
Acceptance tests:							
without extra quality requirements							0
with an extra quality inspection certificate							1
acc. to customer's request*							X

* - after agreeing with the manufacturer.

ORDER EXAMPLE:

the code: **N30U - 1 0 26 00 E 0** means:

- N30U** – programmable digital meter type,
- 1** – supply: 85...253 V a.c/d.c.(45...65 Hz),
- 0** – lack of additional outputs,
- 26** – unit „°C“ acc. to the table 3,
- 00** – standard version,
- E** – English language,
- 0** – without extra quality requirements.

Code	Unit	Code	Unit
00	Lack of unit	29	%
01	V	30	%RH
02	A	31	pH
03	mV	32	kg
04	kV	33	bar
05	mA	34	m
06	kA	35	l
07	W	36	s
08	kW	37	h
09	MW	38	m ³
10	var	39	turns
11	kvar	40	pcs
12	Mvar	41	imp
13	VA	42	rps
14	kVA	43	m/s
15	MVA	44	l/s
16	kWh	45	rev/min
17	MWh	46	r.p.m.
18	kvarh	47	mm/min
19	Mvarh	48	m/min
20	kVAh	49	l/min
21	MVAh	50	m ³ /min
22	Hz	51	pcs/h
23	kHz	52	m/h
24	Ω	53	km/h
25	k Ω	54	m ³ /h
26	°C	55	kg/h
27	°F	56	l/h
28	K	XX	on order1)

1) - after agreeing with the manufacturer.

10. MAINTENANCE AND GUARANTEE

The N30U digital panel meter does not require any periodical maintenance.

In case of some incorrect operations:

1. From the Shipping Date, During the Period Given in the Annexed Guarantee Card

One should take the meter down from the installation and return it to the Manufacturer's

Quality Control Dept.

If the meter has been used in compliance with the instructions, the Manufacturer warrants to repair it free of charge.

2. After the Guarantee Period:

One should turn over the meter to repair it in a certified service workshop.

The disassembling of the casing causes the cancellation of the granted guarantee.

Our policy is one of continuous improvement and we reserve the right to make changes in design and specifications of any products as engineering advances or necessity requires and revise the above specifications without notice.

SALES PROGRAM

- DIGITAL AND BARGRAPH PANEL METERS
- MEASURING TRANSDUCERS
- ANALOG PANEL METERS (DIN INSTRUMENTS)
- ANALOG AND DIGITAL CLAMP-ON METERS
- INDUSTRIAL CONTROLLERS FOR AUTOMATION
- CHART AND PAPERLESS RECORDERS
- POWER CONTROL UNITS AND SOLIDE-STATE RELAYS
- 1-PHASE AND 3-PHASE ELECTRONIC WATT-HOUR METERS
- INTEGRATION ELEMENTS OF MEASURING NETWORKS
- LARGE-SIZE ALPHANUMERICAL DISPLAY PANELS
- ACCESSORIES FOR MEASURING INSTRUMENTS (SHUNTS AND TRANSFORMERS)
- MEASURING SYSTEMS (ENERGY, HEAT, CONTROL)
- CUSTOM-MADE PRODUCTS

WE ALSO OFFER OUR SERVICES IN THE PRODUCTION OF:

- ALUMINIUM ALLOY PRESSURE CASTINGS
- PRECISION ENGINEERING AND THERMOPLASTICS PARTS
- SMT ASSEMBLY SERVICES
- SUBCONTRACTED ELECTRONIC PRODUCTS

QUALITY PROCEDURES:

ACCORDING TO ISO 9001 AND ISO 14001 INTERNATIONAL REQUIREMENTS.

ALL OUR INSTRUMENTS HAVE CE MARK.

FOR MORE INFORMATION, PLEASE WRITE TO OR PHONE OUR EXPORT DEPARTMENT

N30U-07



Lubuskie Zakłady Aparatów Elektrycznych LUMEL S.A.

ul. Sulechowska 1

65-022 Zielona Góra - Poland

Tel.: (48-68) 329 51 00 (exchange)

Fax: (48-68) 329 51 01

e-mail: lumel@lumel.com.pl

<http://www.lumel.com.pl>

Export Department:

Tel.: (48-68) 329 53 02 or 53 04

Fax: (48-68) 325 40 91

e-mail: export@lumel.com.pl