



# PANEL MASTER DESIGNER

## Table of Content

- Chapter 01** – Introduction
- Chapter 02** – Creating Projects
- Chapter 03** – Creating Panel Applications
- Chapter 04** – Designing Screens
- Chapter 05** – Buttons And Switches
- Chapter 06** – Lamps
- Chapter 07** – Displaying And Inputting Data
- Chapter 08** – Graphs And Charts
- Chapter 09** – Animated Objects
- Chapter 10** – Recipes And Recipes Objects
- Chapter 11** – Alarms And Alarm Displays
- Chapter 12** – Data Collection And Historic Displays
- Chapter 13** – Operation Logging
- Chapter 14** – Using Macros

# CHAPTER 1

## INTRODUCTION

<b>1.1. Getting Started</b> .....	<b>1</b>
1.1.1.Documentation Conventions .....	1
<b>1.2. Project Development Steps</b> .....	<b>2</b>
<b>1.3. Installing PM Designer</b> .....	<b>3</b>
1.3.1.System Requirements.....	3
1.3.2.Software Installation PM Designer .....	3
<b>1.4. Using PM Designer</b> .....	<b>5</b>
1.4.1.Main Menus .....	5
1.4.2.Toolbars .....	17
1.4.3.Project Manager.....	25
1.4.4.Screen Manager .....	33
1.4.5.Popup Menus.....	35



## 1.1. Getting Started

### Welcome to PM Designer

#### The configuration software for PM Designer and PM Designer HMI products

Thank you for purchasing PM Designer. This manual describes PM Designer operation procedures and details about each feature.

#### Notes

- 1) All programs and documentation included with PM Designer ("this product") are the copyright of Maxthermo-Gitta Group Corporation, and are licensed to the user under the Software License Agreement. Any violation of the conditions described in the Software License Agreement is prohibited under Taiwanese and international laws.
- 2) Maxthermo-Gitta Group Corporation makes every attempt to provide the user with functionality and usability of the Product and accuracy of its documentation. However, if you should find any errors or omissions in this manual, please contact Maxthermo-Gitta Group Corporation.
- 3) Regardless of the above provisions, Maxthermo-Gitta Group Corporation shall not be held responsible for any damages or third party claims resulting from the use of this product.
- 4) Difference may occur between the descriptions found in this manual and the actual functioning of this product. For the latest information, please refer to the provided data files (i.e. readme.txt files, etc) or other Maxthermo-Gitta Group Corporation.
- 5) Information recorded in or displayed by this product may include content related to intangible assets or intellectual properties owned by Maxthermo-Gitta Group Corporation or by a third-party. However, this does not imply that Maxthermo-Gitta Group Corporation grants the user or other third-parties any license or permits to use such assets or properties.

#### Precautions

- 1) Do not use the touch panel switch as an emergency stop switch. For safety reasons, it is required that all industrial machinery and systems must be equipped with a mechanical, manually-operated emergency stop switch.
- 2) Do not use the touch panel switch that could result in human injury or equipment damage. Failure with the touch panel, the processing unit, and the cables that makes the output stuck at ON or OFF could result in a serious accident.

### 1.1.1. Documentation Conventions

#### Product-related Abbreviations and Terminology

This manual uses the following terminology.

Terminology	Description
Controller	Indicates controller, such as programmable logic controllers (PLCs), motion controllers, thermal controllers, inverters, and so on.
Application	The screen application created with the PM Designer on the PC.
Target Panel	The HMI (Human-Machine Interface) unit or the computer that runs PM SCADA where the screen application is downloaded to and displayed.

This manual uses the following abbreviations.

Abbreviations	Corresponding Target Panel
MD	All PM Designer Series
M-SCADA	PM SCADA
MT	PM Touch Screen ( MT Series Human Machine Interface )
LSK	ML-037-LSK, MT-037-LSK, MT-037V-LSK, ML-057-LSK, MT-057-LSK, MT-057V-LSK
TSK	ML-057-TSK, MT-057-TSK, MT-057V-TSK





## 1.2. Project Development Steps

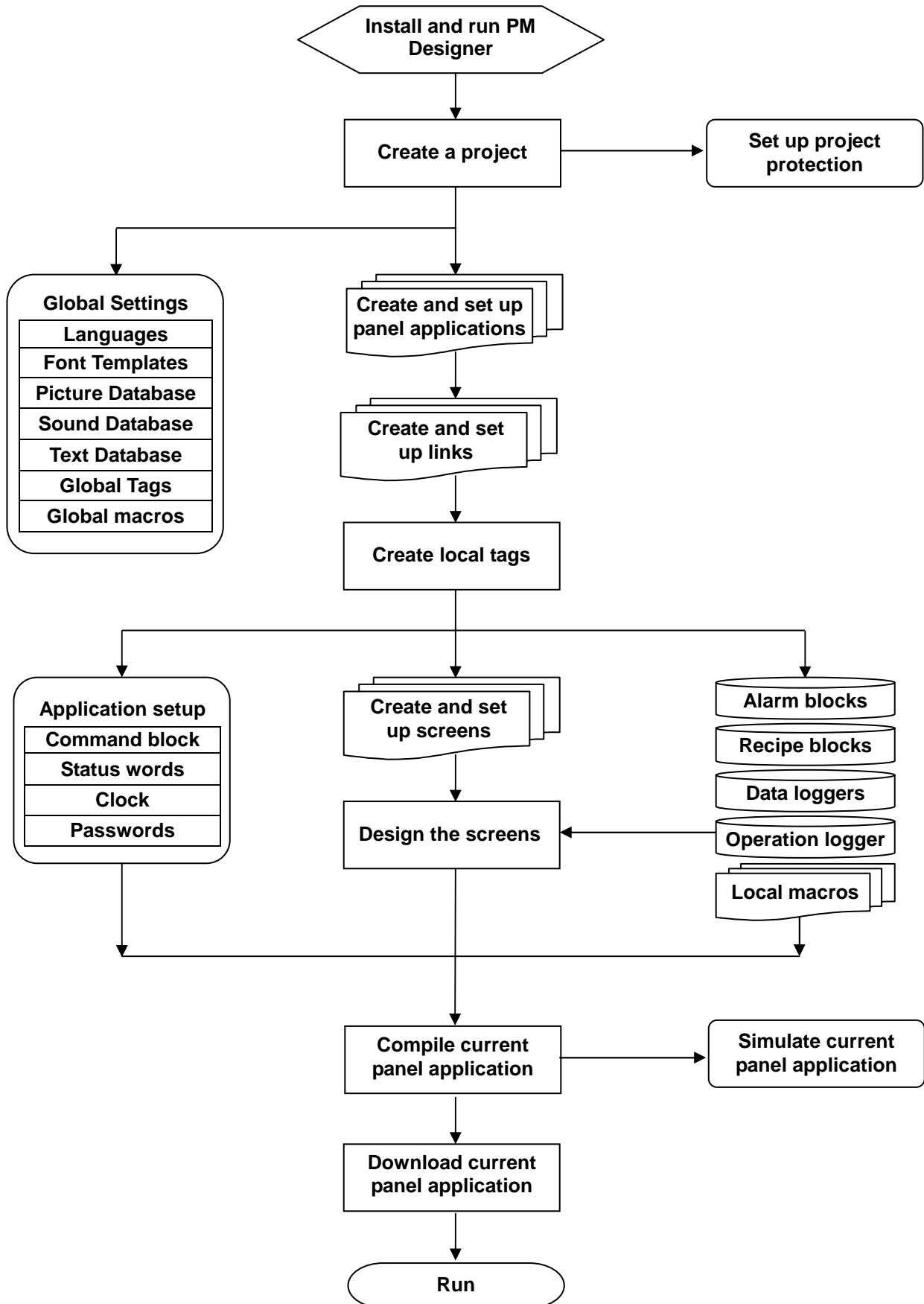



## 1.3. Installing PM Designer

### 1.3.1. System Requirements

The following hardware / software is required to use PM Designer.

#### Free hard disk space

PM Designer, once installed, takes around 170 MB of hard disk space. The installation procedure (only at installation time) requires twice as much (i.e. 340 MB).

#### RAM Working Memory

The memory requirements are as required by the OS. However minimum of 512MB RAM is recommended for decent performance when user is having large projects with high color bitmaps.

#### Minimum OS requirements :

Windows 2000™ SP4

Windows XP™ SP2 (for all flavors of XP such as Home, Media Center, Tablet PC)

Windows Server 2003™

Windows Vista™

### 1.3.2. Software Installation PM Designer

#### ■ Installing PM Designer

To install PM Designer, you may do the followings:

1. Close all other programs.
2. Select and click setup.exe in the CD or PM Designer installation folder.
3. Follow the on screen prompts.
4. The default location for the PM Designer software is "c:\Program Files\ PM Designer. If you prefer to change the software at a different location on your hard drive, you have that option.

The installation procedure will create a program group entitled "PM Designer" within Windows™ .



A PM Designer icon will be added to your desktop. PM Designer also appears on the Windows™ start menu under **Start > All Programs > PM Designer**.

#### ■ Technical Support

For the questions about the PM Designer software, contact **PM** by sending an email to the following address: [gitta@ms9.hinet.net](mailto:gitta@ms9.hinet.net).

#### ■ How to Report a Bug

The PM Designer development team is proud to present a high quality program with minimal bugs. Despite their best efforts, however, bugs do occasionally appear in the software. Should you notice a problem with the software that you think may be a bug, please report it to PM Designer. Please e-mail to [gitta@ms9.hinet.net](mailto:gitta@ms9.hinet.net)

Please include as much information as possible, including a description of the irregularity, the type of PC and panel that you have, any other software that was running when the problem occurred, and the sequence of steps that led to the problem.

#### ■ PM Designer Software License

This is a legal agreement between you (either an individual or a single entity) and PM for the PM Designer SOFTWARE, which includes computer software and may include associated media, printed materials, and 'on-line' electronic documentation.



By installing, copying, downloading, accessing, or otherwise using the PM Designer SOFTWARE, you agree to be bound by the terms of this License. If you do not agree to the terms of this agreement, do not install or use the PM Designer SOFTWARE; you may, however, return it to your place of purchase for a full refund.

## ■ Software License

The PM Designer SOFTWARE is protected by copyright laws and international copyright treaties, as well as other intellectual property laws and treaties. The PM Designer SOFTWARE is licensed, not sold.

## ■ Grant of License

With this License **PM** grants you the non-exclusive right to use the PM Designer SOFTWARE in accordance with the following terms:

You may install, use, access, display, run, or otherwise interact with ('RUN') one copy of the PM Designer SOFTWARE on a single computer, workstation ('COMPUTER'). The primary user of the COMPUTER on which the PM Designer SOFTWARE is installed may make a second copy for his or her exclusive use on a portable computer.

You may also store or install a copy of the PM Designer SOFTWARE on a storage device, such as a network server, used only to RUN the PM Designer SOFTWARE on your other COMPUTERS over an internal network; however, you must acquire and dedicate a license for each separate COMPUTER on which the PM Designer SOFTWARE is RUN from the storage device. A license for the PM Designer SOFTWARE may not be shared or used concurrently on different COMPUTERS.

## ■ Transfer of License

The initial licensee of the PM Designer SOFTWARE may make a one-time permanent transfer of this License and the PM Designer SOFTWARE only directly to an end user. This transfer must include all of the PM Designer SOFTWARE (including all component parts, the media and printed materials and this License). The transferee of such one-time transfer must agree to comply with the terms of this License, including the obligation not to further transfer this License and the PM Designer SOFTWARE.

## ■ Limitations

You may not reverse engineer, decompile, or disassemble the PM Designer SOFTWARE, except and only the extent that such activity is expressly permitted by applicable law notwithstanding this limitation.

The PM Designer SOFTWARE is licensed as a single product, its component parts may not be separated for use on more than one COMPUTER.

## ■ Copyright

All title and copyrights in and to the PM Designer SOFTWARE (including but not limited to any images, photographs, animations, video, audio, music and text incorporated into the PM Designer SOFTWARE), the accompanying printed materials, and any copies of the PM Designer are owned by **PM** or its suppliers. If this PM Designer SOFTWARE contains documentation which is provided only in electronic form, you may print one copy of such electronic documentation. You may not copy the printed materials accompanying the PM Designer SOFTWARE.

## ■ Intellectual Property

The Intellectual Property of the PM Designer SOFTWARE (including but not limited to any images, photographs, animations, video, audio, music and text incorporated into the PM Designer SOFTWARE) is owned by **PM** International.

## ■ Disclaimer (Limited Warranty)

The PM Designer SOFTWARE is provided 'as is' and without warranty of any kind, express, implied or otherwise, including without limitation, any warranty of merchantability or fitness for a particular purpose.



In no event shall **PM** be liable for any special, incidental, indirect or consequential damages of any kind, or any damages whatsoever resulting from loss of use, data or profits, whether or not advised of the possibility of damage, and on any theory of liability, arising out of or in connection with the use of the PM Designer SOFTWARE.

## 1.4. Using PM Designer







### 1.4.1. Main Menus

There are 11 menus you can select in the main menu: File, Edit, View, Screen, Draw, Object, Project, Panel, Tools, Window, Help.

#### 1.4.1.1. File Menu

Icon	Menu Item	Shortcut	Description
	New	Ctrl+N	Create a new PM Designer project.
	Open...	Ctrl+O	Open an existing PM Designer project.
	Close		Close the current project.
	Save	Ctrl+S	Save the current project.
	Save As...		Save the current project with a new name.
	<Recently opened filename>		Open the referred project.
	Exit		Quit PM Designer.

#### 1.4.1.2. Edit Menu





Icon	Menu Item	Popup Menu Item	Shortcut	Description
	Undo		Ctrl+Z	Undo the last action.
	Redo		Ctrl+Y	Redo the previously undone action.
	Cut		Ctrl+X	Cut the selection and put it on the Clipboard.
	Copy		Ctrl+C	Copy the selection and put it on the Clipboard.
	Paste		Ctrl+V	Place the Clipboard contents on the current screen.
	Delete		Del	Delete the selection.
	Duplicate...			Duplicate the selected object.
	Fine and Replace	Find...		Find the specified text.
		Replace...		Replace specific text with different text.
	Show Grid			Show or hide the grid.
	Snap to Grid			Select or deselect the option of aligning objects to the grid points.
	Grid Settings...			Opens the Grid Settings dialog box.
	Select All		Ctrl+A	Select entire objects of the active screen.
	Group			Group the selection.
	Ungroup			Ungroup the selected group.

Continued



Icon	Menu Item	Popup Menu Item	Description
	Pin		Pin the selection so it can not move.
	Unpin		Unpin the selection so it can move again.
	Auto Text Resizing		Select or deselect the option of automatic text resizing.
	Align	Left	Align the left sides of selected objects to the left side of the reference object. All the objects move horizontally so their left sides are in line with the left side of the reference object.
		Vertical Center	Align the vertical centers of selected objects to the vertical center of the reference object. All the objects move horizontally so their vertical centers are in line with the vertical center of the reference object.
		Right	Align the right sides of selected objects to the right side of the reference object. All the objects move horizontally so their right sides are in line with the right side of the reference object.
		Top	Align the tops of the selected objects to the top of the reference object. All the objects move vertically so their tops are in line with the top of the reference object.
		Horizontal Center	Align the horizontal centers of selected objects to the horizontal center of the reference object. All the objects move vertically so their horizontal centers are in line with the horizontal center of the reference object.
		Bottom	Align the bottoms of selected objects to the bottom of the reference object. All the objects move vertically so their bottoms are in line with the bottom of the reference object.
		To Grid	Select or deselect the option of aligning objects to the grid points.
		Make Same Size	Width
	Height		Make the selected objects have the same height as the reference object.
	Both		Make the selected objects have the same width and height as the reference object.
	Nudge	Left	Nudge the selection left. When the Snap to Grid option is not selected, all objects of the selection move one pixel left. When the Snap to Grid option is selected, each object of the selection moves left to where its upper-left corner aligns to the nearest grid point.
		Right	Nudge the selection right. When the Snap to Grid option is not selected, all objects of the selection move one pixel right. When the Snap to Grid option is selected, each object of the selection moves right to where its upper-left corner aligns to the nearest grid point.
		Up	Nudge the selection up. When the Snap to Grid option is not selected, all objects of the selection move one pixel up. When the Snap to Grid option is selected, each object of the selection moves up to where its upper-left corner aligns to the nearest grid point.
		Down	Nudge the selection down. When the Snap to Grid option is not selected, all objects of the selection move one pixel down. When the Snap to Grid option is selected, each object of the selection moves down to where its upper-left corner aligns to the nearest grid point.

Continued

Icon	Menu Item	Popup Menu Item	Description
	Layer	Bring to Top	Bring the selection to the top.
		Bring Forward	Bring the selected object one layer up.
		Send Backward	Send the selected object one layer down.
		Send to Bottom	Send the selection to the bottom.
	Set Order		Start the order setting process for the objects of the active screen.
	Object Properties...		Open the property sheet of the selected object.
	Save as Default		Save the selected object as the default object for the type of that object. Default objects are saved in the Objects category of the object library.
	Save to Object Library...		Save the selected object to the object library.
	Save as Global Object...		Save the selected object as the global object which is saved in the Global category of the object library. Global Objects can be used for the Global Object Containers.

**Note:**

1. To select a reference object from the selection, use [Ctrl+Click].
2. To add an object to the selection, use [Shift+Click].

### 1.4.1.3. View Menu



Icon	Menu Item	Popup Menu Item	Description
	Address	Write/Monitor	Display the Write address and Monitor address defined for each object of all the opened screens.
		Write	Display the Write address defined for each object of all the opened screens.
		Monitor	Display the Monitor address defined for each object of all the opened screens.
		Read	Display the Read address defined for each object of all the opened screens.
		Notification	Display the Notification address defined for each object of all the opened screens.
		Touch Operation Control	Display the address of the Touch Operation Control bit defined for each object of all the opened screens.
		Visibility Control	Display the address of the Visibility Control bit defined for each object of all the opened screens.
	Show Tips		Select or deselect the option of displaying tip for the toolbar icon or the object on which the cursor stays.

Continued



Icon	Menu Item	Popup Menu Item	Description
	Zoom	25%	Display screens in 25% of their normal sizes.
		50%	Display screens in 50% of their normal sizes.
		70%	Display screens in 70% of their normal sizes.
		80%	Display screens in 80% of their normal sizes.
		90%	Display screens in 90% of their normal sizes.
		100%	Display screens in normal size.
		150%	Display screens in 150% of their normal sizes.
		200%	Display screens in 200% of their normal sizes.
		300%	Display screens in 300% of their normal sizes.
	Normal Size		Display screens in normal size.
	Project Manager		Show or hide Project Manager.
	Screen Manager		Show or hide Screen Manager.
	Screen Overview		Show or hide Screen Overview.
	Link Overview		Show or hide Link Overview.
	Object Library		Show or hide Object Library.
	Macro Command Properties		Show or hide Macro Command Properties window.
	Object List		Show or hide Object List.
	I/O List		Show or hide I/O List.
	Standard Toolbar		Show or hide Standard toolbar.
	Object Toolbar		Show or hide Object toolbar.
	Draw Toolbar		Show or hide Draw toolbar.
	Text Toolbar		Show or hide Text toolbar.
	Edit Toolbar		Show or hide Edit toolbar.
	Address Toolbar		Show or hide Address toolbar.
	Picture Toolbar		Show or hide Picture toolbar.
	Status Bar		Show or hide Status bar.
	Semi-transparent Object Dialog View		Select or deselect the option of displaying the object property dialog box in semi-transparent mode. A semi-transparent dialog box allows you to see the objects underlying the dialog box.
	<Language name>		Display the text of objects in the selected language.





## 1.4.1.4. Screen Menu

Icon	Menu Item	Description
	New Screen...	Create a new screen for the current panel application.
	Open Screen...	Open an existing screen of the current panel application.
	Close Screen	Close the current screen.
	Close All Screens	Close all the opened screens.
	Cut Screen	Cut the current screen and put it on the Clipboard.
	Copy Screen	Copy the current screen and put it on the Clipboard.
	Paste Screen	Insert the screen on the Clipboard to the current panel application.
	Delete Screen	Delete the current screen.
	Stretch Screen...	Stretch the current screen.
	Export Screen...	Export the current screen to a file.
	Import Screen...	Import a screen from a file for the current panel application.
	Save Current Screen as Picture...	Save the current screen to a picture file.
	Save Screens as Pictures...	Open the Save Screens as Pictures dialog box. You can save each of the selected screens to a picture file using the dialog box.
	Screen Properties	Open the screen property dialog box for the current screen.





























1.4.1.5. Draw Menu

Icon	Menu Item	Description
	Dot	Get ready to place a copy of the default dot on a screen.
	Line	Get ready to place a copy of the default line on a screen.
	Horizontal Line	Get ready to place a copy of the default horizontal line on a screen.
	Vertical Line	Get ready to place a copy of the default vertical line on a screen.
	Polyline	Get ready to draw a polyline on a screen.
	Rectangle	Get ready to place a copy of the default rectangle on a screen.
	Round Rectangle	Get ready to place a copy of the default round rectangle on a screen.
	Clipped Rectangle	Get ready to place a copy of the default clipped rectangle on a screen.
	Circle	Get ready to place a copy of the default circle on a screen.
	Ellipse	Get ready to place a copy of the default ellipse on a screen.
	Arc	Get ready to place a copy of the default arc on a screen.
	Pie	Get ready to place a copy of the default pie shape on a screen.
	Polygon	Get ready to draw a polygon on a screen.
	Text	Get ready to place a copy of the default text object on a screen.
	Picture	Get ready to place a copy of the default picture object on a screen.
	Scale	Get ready to place a copy of the default scale on a screen.
	Table	Get ready to place a copy of the default table on a screen.

## 1.4.1.6. Object Menu

Icon	Menu Item	Popup Menu Item	Description
	Bit Button		Get ready to place a copy of the default bit button on a screen.
	Toggle Switch		Get ready to place a copy of the default toggle switch on a screen.
	Screen Button		Get ready to place a copy of the default screen button on a screen.
	Function Button		Get ready to place a copy of the default function button on a screen.
	Slide Switch		Get ready to place a copy of the default slide switch on a screen.
	More buttons	Word Button	Get ready to place a copy of the default word button on a screen.
		Multistate Switch	Get ready to place a copy of the default multistate Switch on a screen.
		Radio Button Group	Get ready to place a copy of the default radio button group on a screen.
		Keypad Button	Get ready to place a copy of the default keypad button on a screen.
		Scroll Button Group	Get ready to place a copy of the default scroll button group on a screen.
		Scroll Bar	Get ready to place a copy of the default scroll bar on a screen.
		Step Button	Get ready to place a copy of the default step button on a screen.
		Page Selector	Get ready to place a copy of the default page selector on a screen.
	Numeric Entry		Get ready to place a copy of the default numeric entry on a screen.
	Numeric Display		Get ready to place a copy of the default numeric display on a screen.
	Advanced Numeric Display		Get ready to place a copy of the default advanced numeric display on a screen.
	Character Entry		Get ready to place a copy of the default ASCII string entry on a screen.
	Character Display		Get ready to place a copy of the default ASCII string display on a screen.
	Bit Lamp		Get ready to place a copy of the default bit lamp on a screen.
	Multistate Lamp		Get ready to place a copy of the default multistate lamp on a screen.
	Message Display		Get ready to place a copy of the default message display on a screen.
	Time/Date	Time Display	Get ready to place a copy of the default time display on a screen.
		Date Display	Get ready to place a copy of the default date display on a screen.
		Day-of-week Display	Get ready to place a copy of the default day-of-week display on a screen.

Continued



Icon	Menu Item	Popup Menu Item	Description
	Meter		Get ready to place a copy of the default meter on a screen.
	Dynamic Graphic	Dynamic Circle	Get ready to place a copy of the default dynamic circle on a screen.
		Dynamic Rectangle	Get ready to place a copy of the default dynamic rectangle on a screen.
		GIF Display	Get ready to place a copy of the default GIF display on a screen.
		Picture Display	Get ready to place a copy of the default picture display on a screen.
		Animated Graphic	Get ready to place a copy of the default animated graphic on a screen.
	Pipeline		Get ready to place a copy of the default pipeline on a screen.
	Graph/Chart	Bar Graph	Get ready to place a copy of the default bar graph on a screen.
		Line Chart	Get ready to place a copy of the default line chart on a screen.
		Circular Bar Graph	Get ready to place a copy of the default circular bar graph on a screen.
		Scatter Chart	Get ready to place a copy of the default scatter chart on a screen.
	Alarm Display		Get ready to place a copy of the default alarm display on a screen.
	Historic Display	Historic Data Table	Get ready to place a copy of the default historic data table on a screen.
		Historic Event Table	Get ready to place a copy of the default historic event table on a screen.
		Historic Trend Graph	Get ready to place a copy of the default historic trend graph on a screen.
		Single Record Data Table	Get ready to place a copy of the default single record data table on a screen.
		Single Record Line Chart	Get ready to place a copy of the default single record line chart on a screen.
		Operation Log Display	Get ready to place a copy of the default operation log display on a screen.
	Recipe Selector		Get ready to place a copy of the default recipe selector on a screen.
	Recipe Table		Get ready to place a copy of the default recipe table on a screen.
	Sublink Table		Get ready to place a copy of the default sublink Table on a screen.
	Global Object Container		Get ready to place a copy of the default global object container on a screen.
	USB Camera View		Get ready to place a copy of the default USB camera view on a screen.

## 1.4.1.7. Project Menu

Icon	Menu Item	Popup Menu Item	Description
	Information & Protection...		Open the Project Information & Protection dialog box. This dialog box shows the basic information of your project and allows you to define how to protect it.
	Languages...		Open the Languages dialog box. You can specify up to 10 languages for your project to support with this dialog box.
	Font Templates...		Open the Font Templates dialog box. With this dialog box, you can specify up to 20 fonts as the frequently used fonts for each language.
	Text Database...		Open the Text Database (dockable window). With Text Database, you can import text, export text, and edit text for your project.
	Picture Database...		Open the Picture Database (dialog box). You can import pictures and organize them for your project in this dialog box.
	Sound Database...		Open the Sound Database (dialog box). You can import sounds for your project in this dialog box.
	Global Tags...		Open the Global Tags window. You can define the global tags in this window.
	Global Macro	Add...	Create a new macro.
		Edit	Select a macro to edit.
		Delete	Select a macro to delete.
	Add New Panel Application...		Create a new panel application.
	Import Panel Application...		Import a panel application from a PLF file.
	Delete Panel Application		Select a panel application to delete.



1.4.1.8. Panel Menu

Icon	Menu Item	Popup Menu Item	Description
	Current Panel	<Panel application name>	Select a panel application as the current application
	Link	Add...	Add a new communication link to the current application.
		Properties	Select a communication link to open its property sheet.
		Delete	Select a communication link to delete.
		Driver List...	Open communication driver list dialog box which lists all the supported communication drivers.
	Tags...		Open the Tags window of the current application. You can define tags for the application in this window.
	Sound Table...		Open the Sound Table (dialog box). You can collect sounds for the current application in this dialog box.
	General Setup...		Open the Panel General Setup dialog box. You can define the general settings for the current application in this dialog box.
	Command & Status...		Open the Command & Status dialog box. You can define the command block and the status words for the current application in this dialog box.
	Clock...		Open the Clock dialog box. You can define the clock operations for the current application in this dialog box.
	Passwords...		Open the Passwords dialog box. You can define passwords and related settings for the application in this dialog box.
	Discrete Alarm Block	Add	Add a new discrete alarm block to the current application.
		Properties	Select a discrete alarm block to open its property sheet.
		Delete	Select a discrete alarm block to delete.
	Analog Alarm Block	Add	Add a new analog alarm block to the current application.
		Properties	Select an analog alarm block to open its property sheet.
		Delete	Select an analog alarm block to delete.
	Recipe Block	Add	Add a new recipe block to the current application.
		Properties	Select a recipe block to open its property sheet.
		Delete	Select a recipe block to delete.
	Data Logger	Add	Add a new data logger to the current application.
		Properties	Select a data logger to open its property sheet.
		Delete	Select a data logger to delete.
	Operation Logging...		Open the Operation Logging dialog box. You can define the settings of operation logging for the current application in this dialog box.
	Macro	Add...	Add a new macro to the current application.
		Edit	Select a macro of the current application to edit.
		Delete	Select a macro of the current application to delete.
	Compile...		Compile the current application to build the runtime data. You can download the runtime data to the target panel. With the runtime data the target panel can perform exactly what you programmed for the application.

Continued

Icon	Menu Item	Popup Menu Item	Description
	Build Panel Runtime Package (PRP)...		Build the panel runtime package (PRP) file for the current application. The PRP file contains the runtime data and the system programs. You can update the target panel without the project file by downloading the PRP file to it. The target panel can also update itself by loading the PRP file from a USB mass storage device.
	Build ROM Image...		Build the ROM image file for the current application. The ROM image file contains the runtime data and the system programs. The target panel can update itself by loading the ROM image file from a micro SD card.
	Download...		Download data to the target panel.
	Upload...		Upload data from the target panel.
	Export Panel Application...		Export the current panel application to a PLF file.

## 1.4.1.9. Tools Menu

Icon	Menu Item	Popup Menu Item	Description								
	Language Selection	Auto	When this item is selected: <table border="1" data-bbox="767 983 1509 1200"> <thead> <tr> <th>Default Language for the Windows</th> <th>Language Used for the U/I of the PM Designer</th> </tr> </thead> <tbody> <tr> <td>Simplified Chinese</td> <td>Simplified Chinese</td> </tr> <tr> <td>Traditional Chinese</td> <td>Traditional Chinese</td> </tr> <tr> <td>Others</td> <td>English</td> </tr> </tbody> </table>	Default Language for the Windows	Language Used for the U/I of the PM Designer	Simplified Chinese	Simplified Chinese	Traditional Chinese	Traditional Chinese	Others	English
Default Language for the Windows		Language Used for the U/I of the PM Designer									
Simplified Chinese		Simplified Chinese									
Traditional Chinese		Traditional Chinese									
Others		English									
	English	Select English as the language for the U/I of the PM Designer.									
	Chinese (Simplified)	Select simplified Chinese as the language for the U/I of the PM Designer.									
	Chinese (Traditional)	Select traditional Chinese as the language for the U/I of the PM Designer.									
	Run Offline Simulation		Run offline simulation for the current application.								
	Run Online Simulation		Run online simulation for the current application.								
	Set Transparent Communication...		Open the Set Transparent Communication dialog box.								
	Start Transparent Communication		Start the transparent communication.								
	End Transparent Communication		End the transparent communication.								
	Update OS0 through BIOS		Update the system program OS0 of the target panel through its BIOS. This operation is useful when the system programs of the target panel were destroyed.								
	Export Text...		Export the text of the current application to a PTX file.								
	Import Text...		Import the text in a PTX file for the selected application.								
	TextEditor		Run the TextEditor program to edit the text of a PTX file.								



1.4.1.10. Window Menu

Icon	Menu Item	Description
	Cascade	Arrange windows so they overlap.
	Tile Vertical	Arrange windows as non-overlapping vertical tiles.
	Tile Horizontal	Arrange windows as non-overlapping horizontal tiles.
	Arrange Icon	Arrange icons at the bottom of the window.
	Restore	Restore the windows to their original sizes and positions.
	Maximize	Maximize the windows
	Opened Window List	Display a list of opened windows titles. You may click the window title to bring the corresponding window to the top.
	Windows...	Open the Windows dialog box to activate or save or close the selected window.

1.4.1.11. Help Sub-menu

Icon	Menu Item	Description
	About PM Designer...	Open the About PM Designer dialog box. You can see the version number of the PM Designer in this dialog box.

## 1.4.2. Toolbars

### 1.4.2.1. Standard Toolbar



Icon	Tool Tip	Description
	New	Create a new PM Designer project.
	Open	Open an existing PM Designer project.
	Save	Save the current project.
	Cut	Cut the selection and put it on the Clipboard.
	Copy	Copy the selection and put it on the Clipboard.
	Paste	Place the Clipboard contents on the current screen.
	Undo	Undo the last edit action.
	Redo	Redo the previously undone edit action.
	New Screen	Create a new screen for the current panel application.
	Screen Properties	Open the screen property dialog box for the current screen.
	Previous Screen	Make the previous screen of the current screen in terms of screen number the current screen.
	Next Screen	Make the next screen of the current screen in terms of screen number the current screen.
	Zoom In	Make the screen view one step bigger.
	Zoom Out	Make the screen view one step smaller.
	Normal Size	Restore the screen view to normal size.
	Off (State 0)	Show the Off state of all the objects on the current screen.
	On (State 1)	Show the On state of all the objects on the current screen.
	State	Select a state for the selected object to show.
	Compile	Compile the current application to build the runtime data. You can download the runtime data to the target panel. With the runtime data the target panel can perform exactly what you programmed for the application.
	Download	Download data to the target panel.
	Download Immediately	Download data using the existing settings to the target panel immediately
	Run Offline Simulation	Run offline simulation for the current application.
	About	Open the About PM Designer dialog box.



















1.4.2.2. Object Toolbar



Icon	Tool Tip	Description
	Bit Button	Get ready to place a copy of the default bit button on a screen.
	Word Button	Get ready to place a copy of the default word button on a screen.
	Screen Button	Get ready to place a copy of the default screen button on a screen.
	Page Selector	Get ready to place a copy of the default page selector on a screen.
	Function Button	Get ready to place a copy of the default function button on a screen.
	Keypad Button	Get ready to place a copy of the default keypad button on a screen.
	Scroll Button Group	Get ready to place a copy of the default scroll button group on a screen.
	Scroll Bar	Get ready to place a copy of the default scroll bar on a screen.
	Radio Button Group	Get ready to place a copy of the default radio button group on a screen.
	Step Button	Get ready to place a copy of the default step button on a screen.
	Toggle Switch	Get ready to place a copy of the default toggle switch on a screen.
	Multistate Switch	Get ready to place a copy of the default multistate Switch on a screen.
	Slide Switch	Get ready to place a copy of the default slide switch on a screen.
	Numeric Entry	Get ready to place a copy of the default numeric entry on a screen.
	ASCII String Entry	Get ready to place a copy of the default ASCII string entry on a screen.
	Advanced Numeric Display	Get ready to place a copy of the default advanced numeric display on a screen.
	Bit Lamp	Get ready to place a copy of the default bit lamp on a screen.
	Multistate Lamp	Get ready to place a copy of the default multistate lamp on a screen.
	Numeric Display	Get ready to place a copy of the default numeric display on a screen.
	ASCII String Display	Get ready to place a copy of the default ASCII string display on a screen.
	Message Display	Get ready to place a copy of the default message display on a screen.
	Meter	Get ready to place a copy of the default meter on a screen.

Continued

Icon	Tool Tip	Description
	Time Display	Get ready to place a copy of the default time display on a screen.
	Date Display	Get ready to place a copy of the default date display on a screen.
	Day-of-week Display	Get ready to place a copy of the default day-of-week display on a screen.
	Dynamic Circle	Get ready to place a copy of the default dynamic circle on a screen.
	Dynamic Rectangle	Get ready to place a copy of the default dynamic rectangle on a screen.
	GIF Display	Get ready to place a copy of the default GIF display on a screen.
	Picture Display	Get ready to place a copy of the default picture display on a screen.
	Animated Graphic	Get ready to place a copy of the default animated graphic on a screen.
	Pipeline	Get ready to place a copy of the default pipeline on a screen.
	Bar Graph	Get ready to place a copy of the default bar graph on a screen.
	Line Chart	Get ready to place a copy of the default line chart on a screen.
	Circular Bar Graph	Get ready to place a copy of the default circular bar graph on a screen.
	Scatter Chart	Get ready to place a copy of the default scatter chart on a screen.
	Alarm Display	Get ready to place a copy of the default alarm display on a screen.
	Historic Data Table	Get ready to place a copy of the default historic data table on a screen.
	Historic Event Table	Get ready to place a copy of the default historic event table on a screen.
	Historic Trend Graph	Get ready to place a copy of the default historic trend graph on a screen.
	Operation Log Display	Get ready to place a copy of the default operation log display on a screen.
	Recipe Selector	Get ready to place a copy of the default recipe selector on a screen.
	Recipe Table	Get ready to place a copy of the default recipe table on a screen.
	Sublink Table	Get ready to place a copy of the default sublink Table on a screen.
	USB Camera View	Get ready to place a copy of the default USB camera view on a screen.











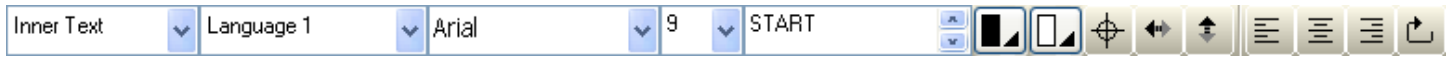

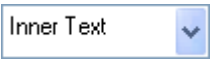
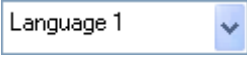

1.4.2.3. Draw Toolbar



Icon	Tool Tip	Description
	Dot	Get ready to place a copy of the default dot on a screen.
	Line	Get ready to place a copy of the default line on a screen.
	Horizontal Line	Get ready to place a copy of the default horizontal line on a screen.
	Vertical Line	Get ready to place a copy of the default vertical line on a screen.
	Polyline	Get ready to draw a polyline on a screen.
	Rectangle	Get ready to place a copy of the default rectangle on a screen.
	Round Rectangle	Get ready to place a copy of the default round rectangle on a screen.
	Clipped Rectangle	Get ready to place a copy of the default clipped rectangle on a screen.
	Polygon	Get ready to draw a polygon on a screen.
	Circle	Get ready to place a copy of the default circle on a screen.
	Ellipse	Get ready to place a copy of the default ellipse on a screen.
	Arc	Get ready to place a copy of the default arc on a screen.
	Pie	Get ready to place a copy of the default pie shape on a screen.
	Table	Get ready to place a copy of the default table on a screen.
	Scale	Get ready to place a copy of the default scale on a screen.
	Text	Get ready to place a copy of the default text object on a screen.
	Picture	Get ready to place a copy of the default picture object on a screen.
	Dot Style	Select a dot style for the selected dot.
	Line Style	Select a line style for the selected shape.
	Border Color	Select a color for the border of the selected shape.
	BG Color	Select a color for the background of the selected solid shape.
	Pattern Style	Select a pattern for the selected solid shape.
	FG/Pattern Color	Select a color for the pattern of the selected solid shape.

## 1.4.2.4. Text Toolbar



Icon	Tool Tip	Description						
	Text Type	Select the type of text you are working on. <table border="1"> <thead> <tr> <th>Text Type</th> <th>Description</th> </tr> </thead> <tbody> <tr> <td>Inner Text</td> <td>Text displayed inside of an object.</td> </tr> <tr> <td>External Text</td> <td>Text of the external label of an object.</td> </tr> </tbody> </table>	Text Type	Description	Inner Text	Text displayed inside of an object.	External Text	Text of the external label of an object.
Text Type	Description							
Inner Text	Text displayed inside of an object.							
External Text	Text of the external label of an object.							
	Language	Select a language that you are defining the text for.						
	Font	Select a font for the text here.						
	Size	Select a font size for the text here.						
	Text	Edit the text here.						
	Text Color	Select a color for the text.						
	Background Color	Select a color for the background of the object.						
	Center Position	Position the text at the center location within the object.						
	Horizontal Position	Change the horizontal position of the text within the object.						
	Vertical Position	Change the vertical position of the text within the object.						
	Align Left	Align the text to the left of the text body.						
	Center	Align the text to the center of the text body						
	Align Right	Align the text to the right of the text body						
	External Label Position	Change the position of the external label.						





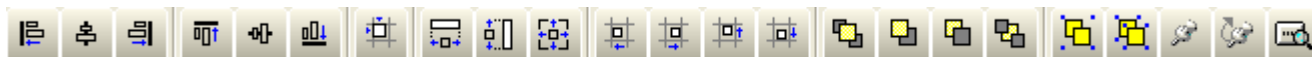





1.4.2.5. Edit Toolbar







Icon	Tool Tip	Description
	Align Left	Align the left sides of selected objects to the left side of the reference object. All the objects move horizontally so their left sides are in line with the left side of the reference object.
	Align Vertical Center	Align the vertical centers of selected objects to the vertical center of the reference object. All the objects move horizontally so their vertical centers are in line with the vertical center of the reference object.
	Align Right	Align the right sides of selected objects to the right side of the reference object. All the objects move horizontally so their right sides are in line with the right side of the reference object.
	Align Top	Align the tops of the selected objects to the top of the reference object. All the objects move vertically so their tops are in line with the top of the reference object.
	Align Horizontal Center	Align the horizontal centers of selected objects to the horizontal center of the reference object. All the objects move vertically so their horizontal centers are in line with the horizontal center of the reference object.
	Align Bottom	Align the bottoms of selected objects to the bottom of the reference object. All the objects move vertically so their bottoms are in line with the bottom of the reference object.
	Snap to Grid	Select or deselect the option of aligning objects to the grid points.
	Make Same Width	Make the selected objects have the same width as the reference object.
	Make Same Height	Make the selected objects have the same height as the reference object.
	Make Same Size	Make the selected objects have the same width and height as the reference object.
	Nudge Left	Nudge the selection left. When the Snap to Grid option is not selected, all objects of the selection move one pixel left. When the Snap to Grid option is selected, each object of the selection moves left to where its upper-left corner aligns to the nearest grid point.
	Nudge Right	Nudge the selection right. When the Snap to Grid option is not selected, all objects of the selection move one pixel right. When the Snap to Grid option is selected, each object of the selection moves right to where its upper-left corner aligns to the nearest grid point.
	Nudge Up	Nudge the selection up. When the Snap to Grid option is not selected, all objects of the selection move one pixel up. When the Snap to Grid option is selected, each object of the selection moves up to where its upper-left corner aligns to the nearest grid point.
	Nudge Down	Nudge the selection down. When the Snap to Grid option is not selected, all objects of the selection move one pixel down. When the Snap to Grid option is selected, each object of the selection moves down to where its upper-left corner aligns to the nearest grid point.

Continued

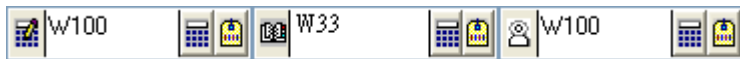
Icon	Tool Tip	Description
	Bring to Top	Bring the selection to the top.
	Bring Forward	Bring the selected object one layer up.
	Send Backward	Send the selected object one layer down.
	Send to Bottom	Send the selection to the bottom.
	Group	Group the selection.
	Ungroup	Ungroup the selected group.
	Pin	Pin the selection so it can not move.
	Unpin	Unpin the selection so it can move again.
	Auto Text Resizing	Select or deselect the option of automatic text resizing.

#### 1.4.2.6. Address Toolbar



Icon	Tool Tip	Description
 W100	Write Address	Specifies the Write address of the selected object.
 W33	Read Address	Specifies the Read address of the selected object.
 W100	Monitor Address	Specifies the Monitor address of the selected object.



1.4.2.7. Picture Toolbar

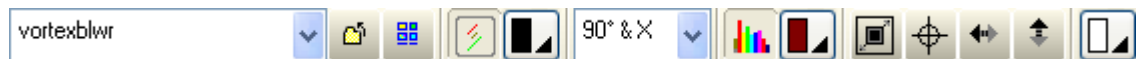

Icon	Tool Tip	Description
	Picture Name	Specifies the picture name. You can select an imported picture here using the drop-down list.
	Import from File	Select a picture from a picture file.
	Select/Import from Library	Select a picture from a PM Designer provided picture library.
	Transparent	Select or deselect the option that parts of the picture are transparent. The transparent parts are pixels having the specified transparent color.
	Transparent Color	Select a color as the transparent color.
	Flip/Rotate	Select a method to rotate/flip the picture.
	Tone	Select or deselect the option that the picture is toned with the specified toning color.
	Toning Color	Select a color as the toning color.
	Fit to Object	Stretch the picture so it has the same size as the object.
	Center	Position the picture at the center location within the object.
	Horizontal Position	Change the horizontal position of the picture within the object.
	Vertical Position	Change the vertical position of the picture within the object.
	Background Color	Select a color for the background of the object.

1.4.2.8. Status Bar

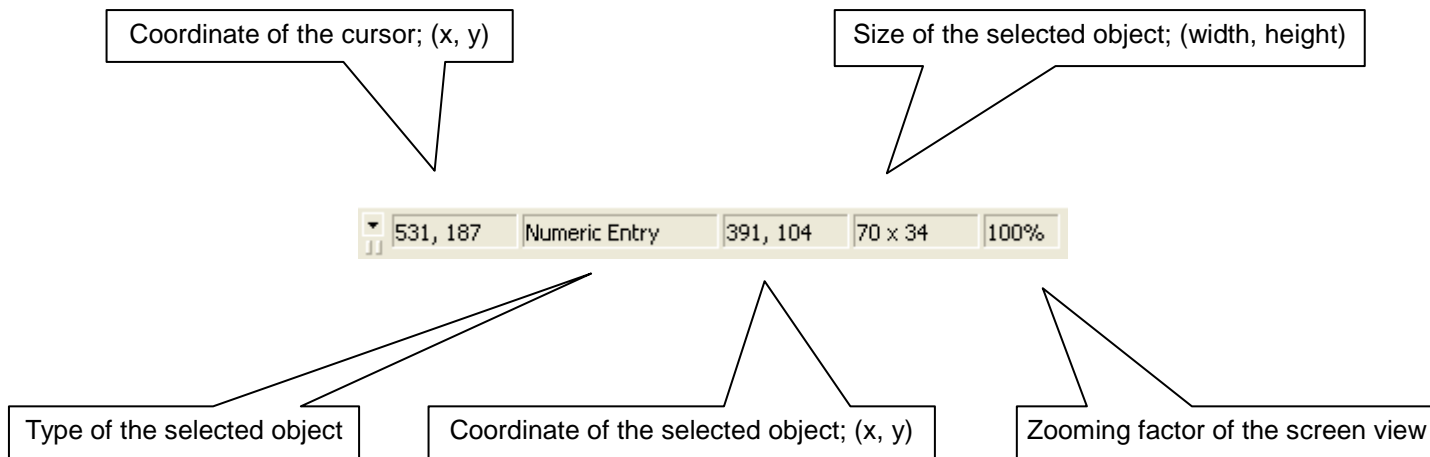

### 1.4.3. Project Manager

The Project Manager is a dockable window with a project tree. You can manage your project with it easily. To open the Project Manager, check the Project Manager menu item in the View menu. The following is an example of the Project Manager. In this example, the project MyProject has two panel applications: MyAP\_1 and MyAp\_2.

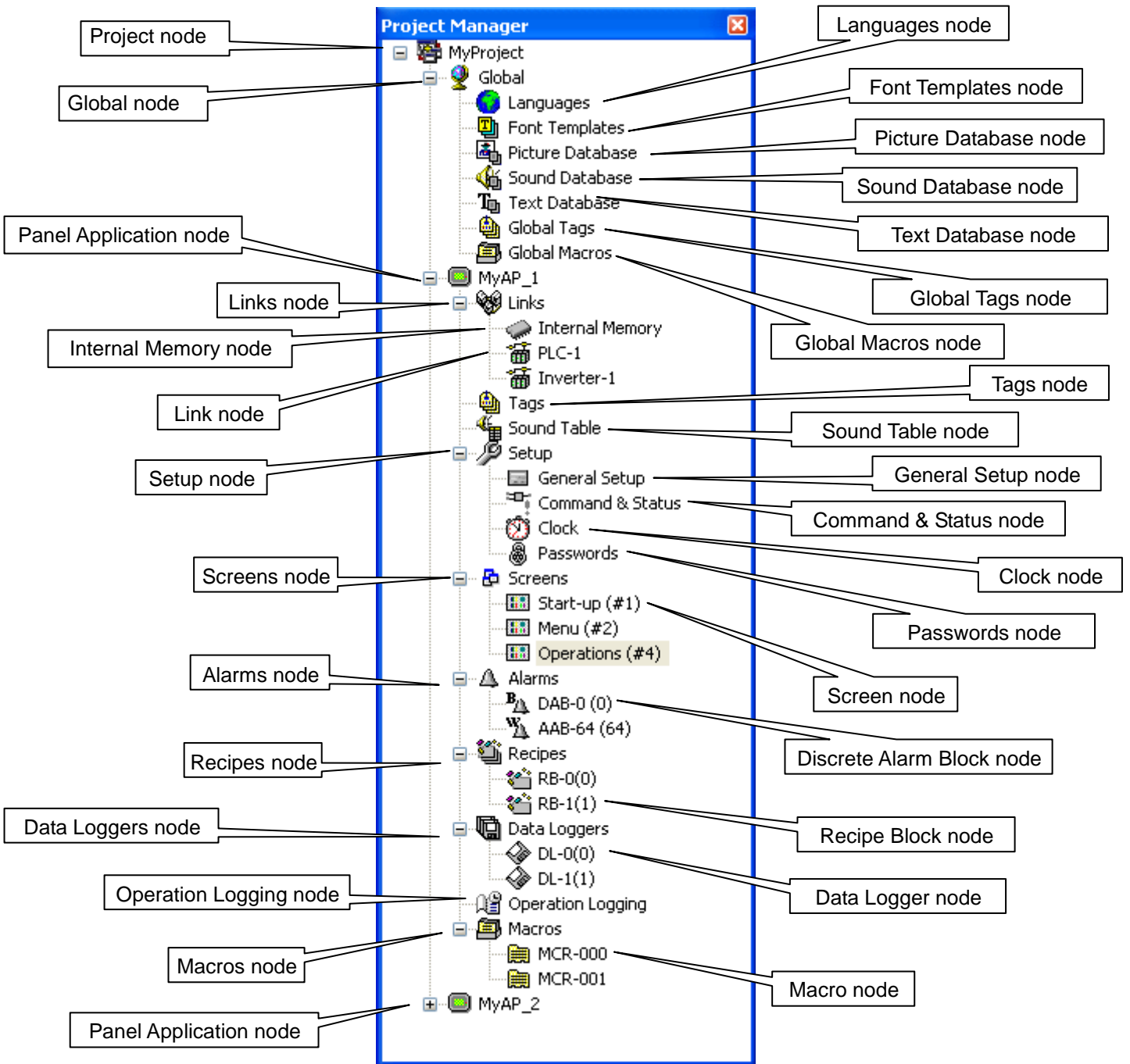





■ **Project Node** (  )

The label of the Project node is the project name. You can do the following with the Project node:

- 1) Double-click it to open the Project Information & Protection dialog box.
- 2) Right-click it to get a popup menu with the following menu items:

Menu Item	Description
Add Panel Application...	Create a new panel application.
Import Panel Application...	Import a panel application from a PLF file.
Information	Open the Project Information & Protection dialog box.
Toggle All	Expand all the collapsed lists of sub-nodes and collapse all the expanded lists of sub-nodes.

■ **Global Node** (  )

The Global node has seven sub-nodes. You can do the following with the Global node:

- 1) Double-click it to expand or collapse the list of its sub-nodes.

■ **Languages Node** (  )

You can do the following with the Languages node:

- 1) Double-click it to open the Languages dialog box.
- 2) Right-click it to get a popup menu with the following menu item:

Menu Item	Description
Properties...	Open the Languages dialog box.

■ **Font Templates Node** (  )

You can do the following with the Font Templates node:

- 1) Double-click it to open the Font Templates dialog box.
- 2) Right-click it to get a popup menu with the following menu item:

Menu Item	Description
Properties...	Open the Font Templates dialog box.

■ **Picture Database Node** (  )

You can do the following with the Picture Database node:

- 1) Double-click it to open the Picture Database dialog box.
- 2) Right-click it to get a popup menu with the following menu item:

Menu Item	Description
Properties...	Open the Picture Database dialog box.

■ **Sound Database Node** (  )

You can do the following with the Sound Database node:

- 1) Double-click it to open the Sound Database dialog box.
- 2) Right-click it to get a popup menu with the following menu item:

Menu Item	Description
Properties...	Open the Sound Database dialog box.

## ■ Text Database Node ( )

You can do the following with the Text Database node:

- 1) Double-click it to open the Text Database dialog box.
- 2) Right-click it to get a popup menu with the following menu item:

Menu Item	Description
Open	Open the Text Database window.

## ■ Global Tags Node ( )

You can do the following with the Global Tags node:

- 1) Double-click it to open the Global Tags window.
- 2) Right-click it to get a popup menu with the following menu item:

Menu Item	Description
Open	Open the Global Tags window.

## ■ Global Macros Node ( )

The Global Macros node can have many Global Macro sub-nodes. Each Global Macro node is associated with a global macro of the project. You can do the following with the Global Macros node:

- 1) Double-click it to expand or collapse the list of its sub-nodes.
- 2) Right-click it to get a popup menu with the following menu items.

Menu Item	Description
Add Macro...	Create a new global macro.
Import Macro...	Import a global macro from an MCR file.

## ■ Global Macro Node ( )

Each Global Macro node is associated with a global macro of the project. You can do the following with the Global Macro node:

- 1) Double-click it to open the editing window of the associated macro.
- 2) Right-click it to get a popup menu with the following menu items.

Menu Item	Description
Open	Open the editing window of the associated macro.
Close	Close the editing window of the associated macro.
Rename	Rename the associated macro.
Delete	Delete the associated macro.
Export Macro...	Export the associated macro to an MCR file.



■ **Panel Application Node** (  )

The label of a Panel Application node is the associated application name. You can do the following with the Panel Application node:

- 1) Double-click it to open the General Setup dialog box.
- 2) Right-click it to get a popup menu with the following menu items:

Menu Item	Description
Rename	Rename the panel application.
Delete	Delete the panel application.
General Setup	Open the General Setup dialog box.
Export Panel Application...	Export the panel application to a PLF file.
Toggle All	Expand all the collapsed lists of sub-nodes and collapse all the expanded lists of sub-nodes.

■ **Links Node** (  )

The Links node has one Internal Memory sub-node and can have up to 16 Link sub-nodes. You can do the following with the Links node:

- 1) Double-click it to expand or collapse the list of its sub-nodes.
- 2) Right-click it to get a popup menu with the following menu item:

Menu Item	Description
Add Link	Create a new communication link.

■ **Internal Memory Node** (  )

You can do the following with the Internal Memory node:

- 1) Double-click it to open the Internal Memory dialog box.
- 2) Right-click it to get a popup menu with the following menu item:

Menu Item	Description
Properties...	Open the Internal Memory dialog box.

■ **Link Node** (  )

A Link node is associated with a communication link. You can do the following with the Link node:

- 1) Double-click it to open the Link Properties dialog box of the associated communication link.
- 2) Right-click it to get a popup menu with the following menu item:

Menu Item	Description
Rename	Rename the associated communication link.
Delete	Delete the associated communication link.
Properties...	Open the Link Properties dialog box of the associated communication link.

■ **Tags Node** (  )

You can do the following with the Tags node:

- 1) Double-click it to open the Tags window.
- 2) Right-click it to get a popup menu with the following menu item:

Menu Item	Description
Open	Open the Tags window.

## ■ Sound Table Node ( )

You can do the following with the Sound Table node:

- 1) Double-click it to open the Sound Table dialog box.
- 2) Right-click it to get a popup menu with the following menu item:

Menu Item	Description
Properties...	Open the Sound Table dialog box.

## ■ Setup Node ( )

The Setup node has four sub-nodes. You can do the following with the Setup node:

- 1) Double-click it to expand or collapse the list of its sub-nodes.

## ■ General Setup Node ( )

You can do the following with the General Setup node:

- 1) Double-click it to open the General Setup dialog box.
- 2) Right-click it to get a popup menu with the following menu item:

Menu Item	Description
Properties...	Open the General Setup dialog box.

## ■ Command & Status Node ( )

You can do the following with the Command & Status node:

- 1) Double-click it to open the Command & Status dialog box.
- 2) Right-click it to get a popup menu with the following menu item:

Menu Item	Description
Properties...	Open the Command & Status dialog box.

## ■ Clock Node ( )

You can do the following with the Clock node:

- 1) Double-click it to open the Clock dialog box.
- 2) Right-click it to get a popup menu with the following menu item:

Menu Item	Description
Properties...	Open the Clock dialog box.

## ■ Passwords Node ( )

You can do the following with the Passwords node:

- 1) Double-click it to open the Passwords dialog box.
- 2) Right-click it to get a popup menu with the following menu item:

Menu Item	Description
Properties...	Open the Passwords dialog box.



■ Screens Node (  )

The Screens node can have many Screen sub-nodes. Each Screen sub-nodes is associated with a screen of the panel application. You can do the following with the Screens node:

- 1) Double-click it to expand or collapse the list of its sub-nodes.
- 2) Right-click it to get a popup menu with the following menu item:

Menu Item	Description
New Screen...	Create a new screen.
Import Screen...	Import a screen from an SNF file.
Sort by Name	Sort the list of Screen sub-nodes by the screen name.
Sort by Number	Sort the list of Screen sub-nodes by the screen number.
Close All Screens	Close all opened screens.
Save Screens as Pictures...	Open the Save Screens as Pictures dialog box. You can save each of the selected screens to a picture file using the dialog box.

■ Screen Node (  )

Each Screen node is associated with a screen of the panel application. You can do the following with the Screen node:

- 1) Double-click it to open the associated screen if the screen is not opened yet.
- 2) Double-click it to open the property sheet of the associated screen if the screen is already opened.
- 3) Right-click it to get a popup menu with the following menu item:

Menu Item	Description
Open	Open the associated screen.
Delete	Delete the associated screen.
Properties	Open the property sheet of the associated screen.
Export Screen...	Export the associated screen to an SNF file.

■ Alarms Node (  )

The Alarms node can have many Discrete Alarm Block sub-nodes and Analog Alarm Block sub-nodes. You can do the following with the Alarms node:

- 1) Double-click it to open the Alarm Properties dialog box.
- 2) Right-click it to get a popup menu with the following menu item:

Menu Item	Description
Add Discrete Alarm Block	Create a new discrete alarm block.
Add Analog Alarm Block	Create a new analog alarm block.
Import Alarm Block...	Import an alarm block from an ALM file.
Properties	Sort the list of Screen sub-nodes by the screen number.
Close All Screens	Open the Alarm Properties dialog box.

## ■ Discrete Alarm Block Node ( )

A Discrete Alarm Block node is associated with a discrete alarm block of the panel application. You can do the following with the Discrete Alarm Block node:

- 1) Double-click it to open the Discrete Alarm Block dialog box of the associated alarm block.
- 2) Right-click it to get a popup menu with the following menu item:

Menu Item	Description
Delete	Delete the associated discrete alarm block.
Properties	Open the Discrete Alarm Block dialog box of the associated discrete alarm block.
Export Alarm Block...	Export the associated alarm block to an ALM file.

## ■ Analog Alarm Block Node ( )

An Analog Alarm Block node is associated with an analog alarm block of the panel application. You can do the following with the Analog Alarm Block node:

- 1) Double-click it to open the Analog Alarm Block dialog box of the associated alarm block.
- 2) Right-click it to get a popup menu with the following menu item:

Menu Item	Description
Delete	Delete the associated analog alarm block.
Properties	Open the Analog Alarm Block dialog box of the associated analog alarm block.
Export Alarm Block...	Export the associated alarm block to an ALM file.

## ■ Recipes Node ( )

The Recipes node can have many Recipe Block sub-nodes. Each Recipe Block sub-node is associated with a recipe block of the panel application. You can do the following with the Recipes node:

- 1) Double-click it to expand or collapse the list of its sub-nodes.
- 2) Right-click it to get a popup menu with the following menu item:

Menu Item	Description
Add Recipe Block	Create a new recipe block.

## ■ Recipe Block Node ( )

A Recipe Block node is associated with a recipe block of the panel application. You can do the following with the Recipe Block node:

- 1) Double-click it to open the Recipe Block dialog box of the associated recipe block.
- 2) Right-click it to get a popup menu with the following menu item:

Menu Item	Description
Delete	Delete the associated recipe block.
Properties	Open the Recipe Block dialog box of the associated recipe block.

**■ Data Loggers Node (  )**

The Data Loggers node can have many Data Logger sub-nodes. Each Data Logger sub-node is associated with a data logger of the panel application. You can do the following with the Data Loggers node:

- 1) Double-click it to expand or collapse the list of its sub-nodes.
- 2) Right-click it to get a popup menu with the following menu item:

Menu Item	Description
Add Data Logger	Create a new data logger.

**■ Data Logger Node (  )**

A Data Logger node is associated with a data logger of the panel application. You can do the following with the Data Logger node:

- 1) Double-click it to open the Data Logger dialog box of the associated recipe block.
- 2) Right-click it to get a popup menu with the following menu item:

Menu Item	Description
Delete	Delete the associated data logger.
Properties	Open the Data Logger dialog box of the associated data logger.

**■ Operation Logging Node (  )**

You can do the following with the Operation Logging node:

- 1) Double-click it to open the Operation Logging dialog box.
- 2) Right-click it to get a popup menu with the following menu item:

Menu Item	Description
Properties...	Open the Operation Logging dialog box.

**■ Macros Node (  )**

The Macros node can have many Macro sub-node. Each Macro node is associated with a macro of the panel application. You can do the following with the Macros node:

- 1) Double-click it to expand or collapse the list of its sub-nodes.
- 2) Right-click it to get a popup menu with the following menu items.

Menu Item	Description
Add Macro...	Create a new macro.
Import Macro...	Import a macro from an MCR file.

**■ Macro Node (  )**

Each Macro node is associated with a macro of the panel application. You can do the following with the Macro node:

- 1) Double-click it to open the editing window of the associated macro.
- 2) Right-click it to get a popup menu with the following menu items.

Menu Item	Description
Open	Open the editing window of the associated macro.
Close	Close the editing window of the associated macro.
Rename	Rename the associated macro.
Delete	Delete the associated macro.
Export Macro...	Export the associated macro to an MCR file.

### 1.4.4. Screen Manager

#### Screen Manager

The Screen Manager is a dockable window. You can manage the screens of your project with it easily. To open the Screen Manager, check the Screen Manager menu item in the View menu. The following is an example of the Screen Manager that lists the screens of the application EV-104 of the project.

The name of the current panel application. You can select another panel application of the project to view.

If the Use box of a screen is checked, the application compiler will generate the runtime data for that screen. If the Use box of screen is unchecked, the application compiler will not generate the runtime data for that screen and will assume that screen is not existing.

Click this icon to get the list view of the screens.

Click this icon to get the thumbnail view of the screens.

Click the thumbnail of a screen to select that screen. The selected screen is highlighted. Use [Ctrl] + click or [Shift] + click to make multiple selections.

Use	Number	Name
<input checked="" type="checkbox"/>	1	Base
<input checked="" type="checkbox"/>	2	Extrusor
<input checked="" type="checkbox"/>	3	Operador
<input checked="" type="checkbox"/>	4	Tiempos Comunes
<input checked="" type="checkbox"/>	5	Tiempos x Estac
<input checked="" type="checkbox"/>	6	Producción
<input checked="" type="checkbox"/>	7	Memoria
<input checked="" type="checkbox"/>	8	Ingenieria 1
<input checked="" type="checkbox"/>	9	Mimico
<input checked="" type="checkbox"/>	10	Neumática
<input checked="" type="checkbox"/>	11	Hidráulica
<input checked="" type="checkbox"/>	12	Variadores
<input checked="" type="checkbox"/>	13	Crono
<input checked="" type="checkbox"/>	14	Programador
<input checked="" type="checkbox"/>	15	Alfa
<input checked="" type="checkbox"/>	16	Alarmas
<input checked="" type="checkbox"/>	17	SEW
<input checked="" type="checkbox"/>	18	Entradas
<input checked="" type="checkbox"/>	19	Alarmas_Listado
<input checked="" type="checkbox"/>	20	Menu
<input checked="" type="checkbox"/>	21	Numerico
<input checked="" type="checkbox"/>	30	Screensaver

Size:640X480;





The following is an example of the Screen Manager that shows the screens in thumbnail view.

If the Use box of a screen is checked, the application compiler will generate the runtime data for that screen. If the Use box of screen is unchecked, the application compiler will not generate the runtime data for that screen and will assume that screen is not existing.

Click the row of a screen to select that screen. The selected screen is highlighted. Use [Ctrl] + click or [Shift] + click to make multiple selections.

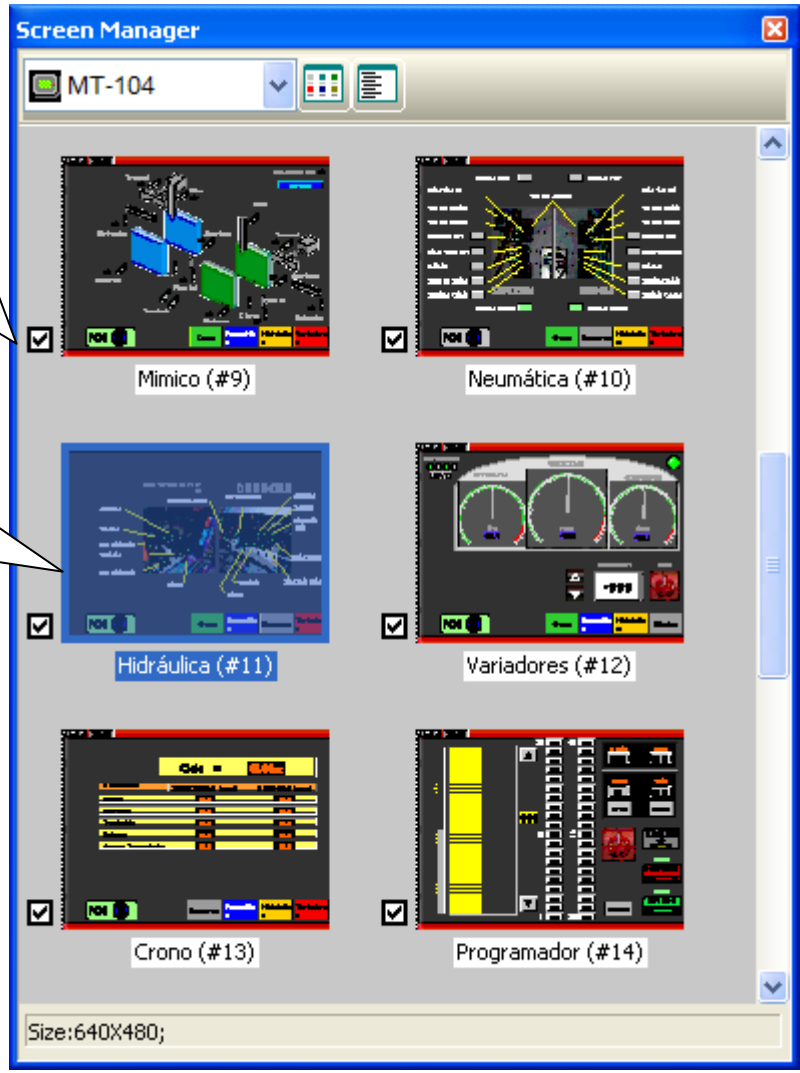











You can right-click the Screen Manager to get the popup menu with the following menu items:

Menu Item	Description
New Screen...	Create a new screen for the current panel application.
Open Screen...	Open the selected screen.
Cut Screen	Cut the selected screen and put it on the Clipboard.
Copy Screen	Copy the selected screen and put it on the Clipboard.
Paste Screen	Insert the screen on the Clipboard to the current panel application.
Delete Screen	Delete the selected screen.
Export Screen...	Export the selected screen to a file.
Import Screen...	Import a screen from a file for the current panel application.
Screen Properties	Open the screen property dialog box of the selected screen.

## 1.4.5. Popup Menus

### 1.4.5.1. Object Popup Menu

#### ■ For all objects

Icon	Menu Item	Shortcut	Description
	Cut	Ctrl+X	Cut the selection and put it on the Clipboard.
	Copy	Ctrl+C	Copy the selection and put it on the Clipboard.
	Paste	Ctrl+V	Place the Clipboard contents on the current screen.
	Delete	Del	Delete the selection.
	Pin		Pin the selection so it can not move.
	Unpin		Unpin the selection so it can move again.
	Duplicate...		Duplicate the selected object.
	Bring to Top		Bring the selection to the top.
	Bring Forward		Bring the selected object one layer up.
	Send Backward		Send the selected object one layer down.
	Send to Bottom		Send the selection to the bottom.
	Object Properties...		Open the property sheet of the selected object.
	Save as Default		Save the selected object as the default object for the type of that object. Default objects are saved in the Objects category of the object library.
	Save to Object Library...		Save the selected object to the object library.
	Save as Global Object...		Save the selected object as the global object which is saved in the Global category of the object library. Global Objects can be used for the Global Object Containers.
	Save Current Screen as Picture...		Save the current screen to a picture file.
	Screen Properties		Open the screen property dialog box for the current screen.

#### ■ For polylines and polygons

Menu Item	Description
Insert Point	Add a point at the specified position.
Delete Point	Delete a selected point.

#### ■ For pipelines

Menu Item	Description
Insert Connector	Add a connector at the specified position. If the specified position is on the vertical pipe segment, you can add left, right or cross connector. If the specified position is on the horizontal pipe segment, you can add up, down or cross connector.
Delete Pipe Segment	Delete a selected connector and its pipe segments.



### 1.4.5.2. Screen Popup Menu

Icon	Menu Item	Description
	Close Screen	Close the current screen.
	Cut Screen	Cut the current screen and put it on the Clipboard.
	Copy Screen	Copy the current screen and put it on the Clipboard.
	Paste Screen	Insert the screen on the Clipboard to the current panel application.
	Delete Screen	Delete the current screen.
	Save Current Screen as Picture...	Save the current screen to a picture file.
	Screen Properties	Open the screen property dialog box for the current screen.



## CHAPTER 2

# CREATING PROJECTS

<b>2.1. Project Information and Protection .....</b>	<b>1</b>
2.1.1. The range limitation of the PM Designer software .....	3
<b>2.2. Global Settings .....</b>	<b>4</b>
2.2.1. Languages .....	5
2.2.2. Font Templates .....	6
2.2.3. Picture Database .....	7
2.2.4. Sound Database .....	11
2.2.5. Text Database .....	13
<b>2.3. Working with Tags .....</b>	<b>16</b>
2.3.1. Types of Tags .....	16
2.3.2. Opening and Closing Tags Editor .....	16
2.3.3. Creating Tags by Tags Editor .....	17
2.3.4. Importing and Exporting Tags .....	20
2.3.5. Adding/Deleting/Renaming Tag Groups .....	20



## 2.1. Project Information and Protection

You can get the project information and set up passwords to protect your project, the password table and the global macros by using the Project information & Protection dialog box. To open the dialog box, you can do one of the followings:

- 1) In the PM Designer's Project Manager tool window, double-click the Project node .
- 2) In the PM Designer's menu bar, click Project to bring up the Project sub-menu. Click Information & Protection... in the Project sub-menu.

The following is an example of the Project Information and Protection dialog box.

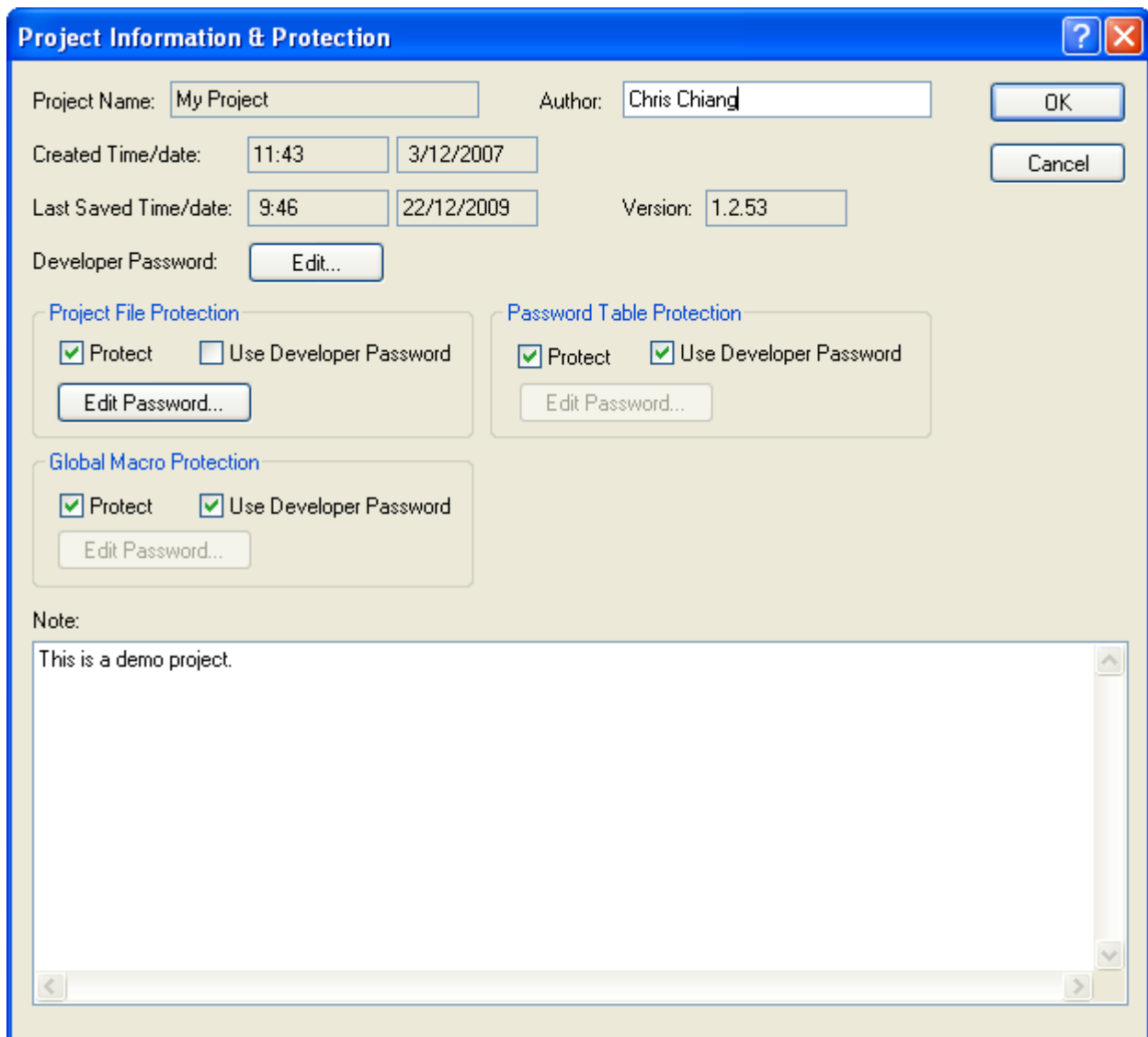

The screenshot shows the 'Project Information & Protection' dialog box. It has a blue title bar with a question mark and a close button. The main area is light beige and contains several sections:

- Project Name:** My Project
- Author:** Chris Chiang
- Created Time/date:** 11:43, 3/12/2007
- Last Saved Time/date:** 9:46, 22/12/2009
- Version:** 1.2.53
- Developer Password:** Edit...
- Project File Protection:**  Protect,  Use Developer Password, Edit Password...
- Password Table Protection:**  Protect,  Use Developer Password, Edit Password...
- Global Macro Protection:**  Protect,  Use Developer Password, Edit Password...

At the bottom, there is a 'Note:' section with a text area containing the text: 'This is a demo project.'

Buttons for 'OK' and 'Cancel' are located in the top right corner.

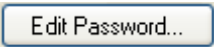
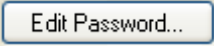
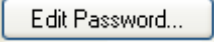

The following table describes how to read or use each of the items in the dialog box.

Item		Description
Project Name		The name of the project. It is also the file name of the project.
Author		The author of the project.
Created Time/date		The time and date when the project was created.
Last Saved Time/date		The last time and date when the project was saved.
Version		The version number of the PM Designer that was used to save the project last time.
Developer Password		Click it to bring up the Edit Developer Password dialog box and specify the developer password.  The developer password must be an unsigned integer and can have up to 9 digits. The default developer password is 000000000 (nine 0's) for new projects and new panels. When you download the runtime data of an application to a panel, the panel compares its developer password with the developer password of that application. If they are identical, the panel accepts the download operation immediately. If they are different, the panel asks you to enter the developer password of the application. This is to make sure you have the right to use the runtime data. After you enter the application's developer password, the panel accepts the download operation and takes the developer password of the application as its developer password.
Project File Protection	Protect	Check this item to enable the project file protection. You need to enter the specified password to open the project file when this item is checked.
	Use Developer Password	Available when the Protect item is checked. Check this item if you want to use the developer password for the protection.
		Available when the Use Developer Password item is unchecked. Click it to bring up the Edit Password dialog box and specify the password.
Password Table Protection	Protect	Check this item to enable the password table protection. You need to enter the specified password to view the password table of any panel application of the project when this item is checked.
	Use Developer Password	Available when the Protect item is checked. Check this item if you want to use the developer password for the protection.
		Available when the Use Developer Password item is unchecked. Click it to bring up the Edit Password dialog box and specify the password.
Global Macro Protection	Protect	Check this item to enable the global macro protection. You need to enter the specified password for viewing any global macro of the project when this item is checked.
	Use Developer Password	Available when the Protect item is checked. Check this item if you want to use the developer password for the protection.
		Available when the Use Developer Password item is unchecked. Click it to bring up the Edit Password dialog box and specify the password.
Note		You can type a note for the project.



### 2.1.1. The range limitation of the PM Designer (SCADA) software

#### (A) The limitation of the general setting and objects:

Item	Description	Old version	PM Designer
01	Number of the languages	10	10
02	Number of the fonts (Each Language)	20	No Limitation
03	Number of the tags	No Limitation	No Limitation
04	Number of the macros	No Limitation	No Limitation
05	Number of the objects (One Screen)	No Limitation	No Limitation
06	Number of the objects (One Project)	No Limitation	No Limitation
07	Number of the panels (One Project)	No Limitation	No Limitation
08	Number of the instructions (One Project)	No Limitation	No Limitation
09	Number of the links	4	MT series HMI: 4 PM SCADA: 16
10	Regular user memory (\$U)	5000-Words	131072-Words
11	Battery backed user memory (\$N)	5000-Words	131072-Words
12	System memory (\$S)	1024-Words	512-Words
13	Number of the screen pages	7999-pages	7999-pages
14	Number of the passwords	User Password: 8 Developer Password: 1	User Password: 8 Developer Password: 1

#### (B) The limitation of the particular objects:

Item	Description	Old version	PM Designer
01	Number of the Discrete Alarm Blocks	16-Blocks	16-Blocks
02	Number of the Analog Alarm Blocks	16-Blocks	16-Blocks
03	Alarm size (Each Block)	Depends on the PLC type	Depends on the PLC type
04	Number of the Recipe Blocks	16-Blocks	16-Blocks
05	Recipe Size (Each Block)	1023-Words	4096-Words
06	Number of the recipes (Each Block)	65535-sets	65535-sets
07	Number of the Data Loggers	16-Blocks	16-Blocks
08	Sample Size (Each Block)	32-Words	128-Words
09	Number of the Samples (Each Block)	65535-sets	65535-sets





## 2.2. Global Settings

Global settings are the settings that can be used by all panel applications in the same project. They are accessible and modifiable throughout your project. The global settings help a designer to construct a project that can be flexible and easy to update. Designers can make changes to the overall design of the panel application by revising the global settings directly.

You can complete all the global settings in the corresponding dialog box. To open the dialog box, you can double-click the related node in the Global node in the PM Designer's Project Manager tool window, or you can click Project to bring up the Project sub-menu in the PM Designer's menu bar, and then click the related command in the Project sub-menu.

The global settings contain the following items.

- **Languages**

Described in [Section 2.2.1](#).

- **Font Templates**

Described in [Section 2.2.2](#).

- **Picture Database**

Described in [Section 2.2.3](#).

- **Sound Database**

Described in [Section 2.2.4](#).

- **Text Database**

Described in [Section 2.2.5](#).

- **Global Tags**

Described in [Section 2.3](#).

- **Global Macros**

Described in [Chapter 14](#).



### 2.2.1. Languages

This section describes how to set up the languages for the project using the Languages dialog box. Each panel application in the project can have up to **10 languages** for the screen texts. The following is an example of the Languages dialog box.

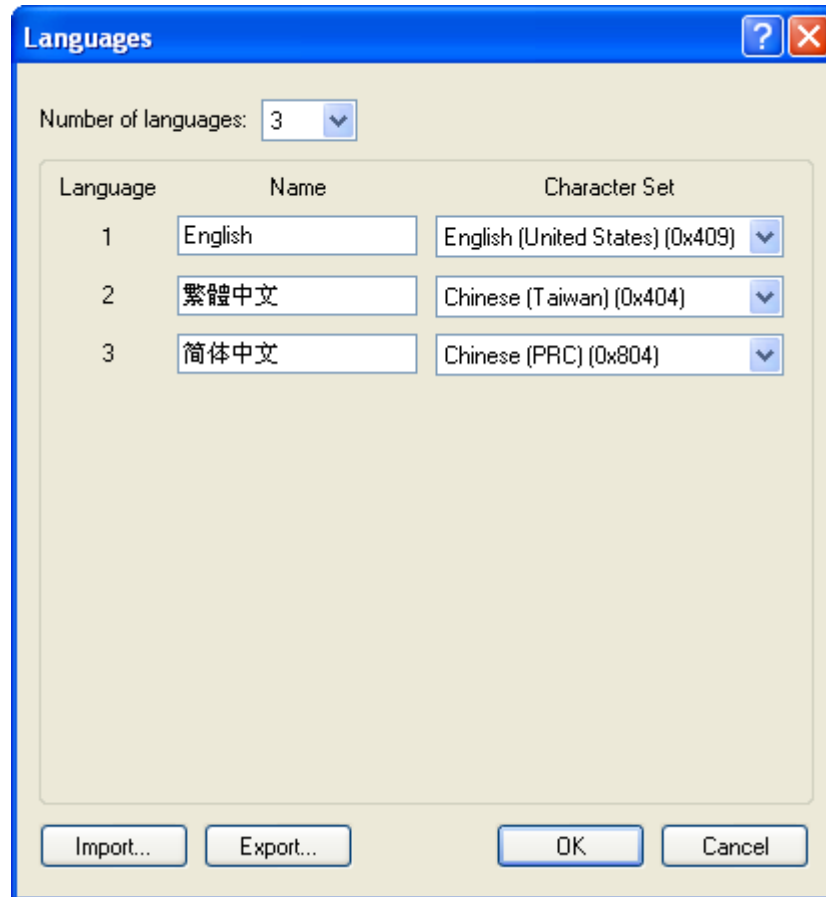

The following table describes each property in the Languages dialog box.

Property	Description
Number of language	Specifies how many languages the project will have.
Language	The index of the language.
Name	Specifies a name for a language. The name must be unique within the project.
Character Set	Specifies the character set for a language to determine how to translate the bytes in the text into characters on the screen.
Import...	Click it to import the languages settings from a LNG file.
Export...	Click it to export the languages settings to a LNG file.
OK	Click it to close the dialog box and accepts all changes.
Cancel	Click it to close the dialog box and discard all changes.

## 2.2.2. Font Templates

The following is an example of the Font Templates dialog box.

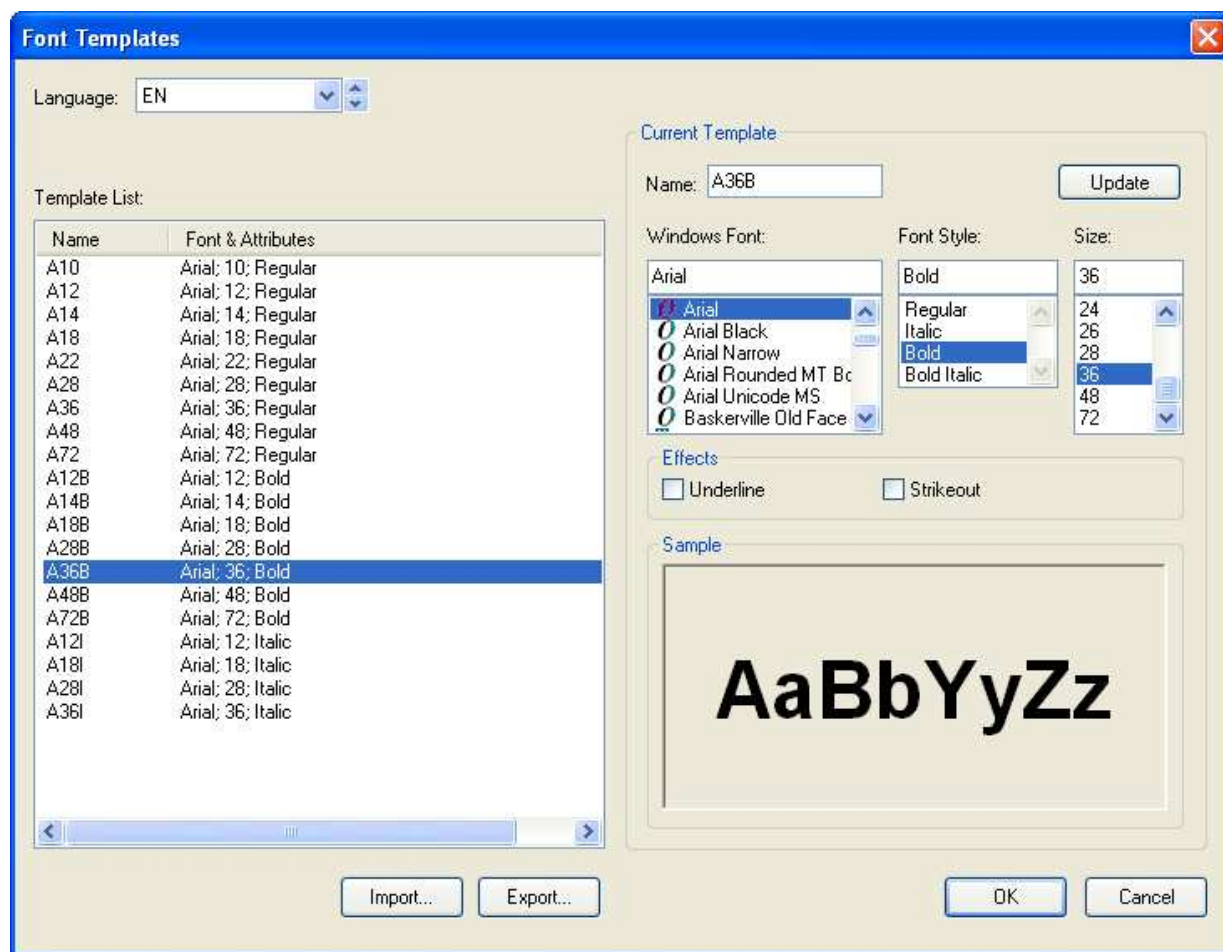

The following table describes how to read or use each of the items in the dialog box.

Item	Description	
Language	Specifies the language that you are working for.	
Template List	Lists the font templates of the selected language. You can select a font template here as the current template.	
Current Template	Name	The name of the current template.
	Windows Font	Specifies the Windows font for the current template.
	Font Style	Specifies the font style for the current template.
	Size	Specifies the size for the current template.
	Underline	Specifies if the Underline feature is selected for the current template.
	Strikeout	Specifies if the Strikeout feature is selected for the current template.
	Update	Click it to update the selected template using the new settings.
Import...	Click it to import the font templates from an FTF file.	
Export...	Click it to export the font templates to an FTF file.	
OK	Click it to close the dialog box and accepts all changes.	
Cancel	Click it to close the dialog box and discard all changes.	





### 2.2.3. Picture Database

The picture database contains all the pictures used by the project. The picture database is empty initially after the project is created.

#### 2.2.3.1. Importing and Exporting Pictures

##### ■ Importing Pictures

You need to import a picture before you can use it for the project. There are 5 ways to import pictures:

- 1) Use the Picture Database dialog box to import one picture at a time from a picture file. The types of importable picture files include: BMP, JPG, GIF, and WMF.
- 2) Use the Picture Database dialog box to import many pictures at a time from a picture database (PDB) file.
- 3) Use the Picture Database dialog box to import one or many pictures at a time by dragging the pictures files from the Windows Explorer to Picture Database list.
- 4) Click the icon  to select and import a picture file when you specify a picture in a dialog box or a property sheet.
- 5) Click the icon  to select and import a picture in a picture database file when you specify a picture in a dialog box or a property sheet.

##### ■ Exporting Pictures

You can export the pictures of the project so the other projects can share those pictures by importing them. There are 2 ways to export pictures:

- 1) Use the Picture Database dialog box to export one picture at a time to a picture file.
- 2) Use the Picture Database dialog box to export many pictures at a time to a picture database (PDB) file.

### 2.2.3.2. Picture Groups

The picture database can contain picture groups.

A picture group is a collection of pictures. Each picture in a picture group represents one state. When a picture group is displayed as the picture shape for an object, the picture that corresponds to the current object state is shown. This is the main benefit of using a picture group as the object shape because it can show each object state with a different picture.

When a picture group is used as the shape for buttons or switches, you may want it to have a different look when it is pressed. In order to support the pressed look, a picture group needs two pictures for each state; one picture is for the normal (released) look and another picture is for the pressed look.

For example, a 3-state multi-state switch needs a picture group that contains 6 pictures as its picture shape if the pressed look is required.

The following is an example of a picture group supporting 3 states and the pressed look.

Picture Group	State	Pictures
	0 (Normal/Released)	
	0 (Pressed)	
	1 (Normal/Released)	
	1 (Pressed)	
	2 (Normal/Released)	
	2 (Pressed)	

**2.2.3.3. Picture Database dialog box**

The following is an example of the Picture Database dialog box.

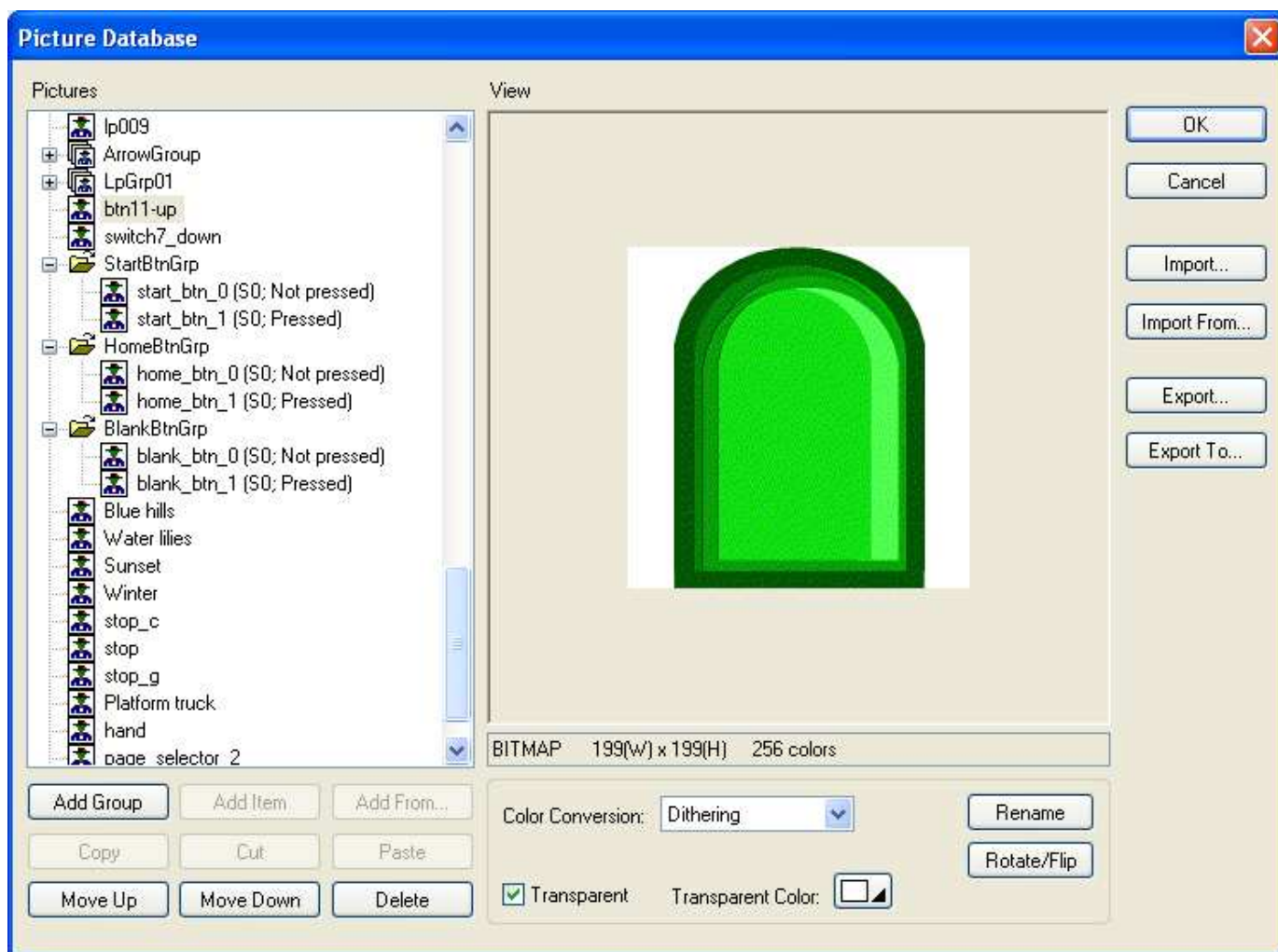



























The following table describes how to read or use each of the items in the dialog box.

Item	Description
Pictures	Lists the pictures and picture groups of the project. You can select a picture or a picture group as the current selection. You can also make multiple selections.
View	Shows the current selection. If the selection is a picture group, the first picture of the group will be shown.
OK	Closes the dialog box and accepts all changes to the picture database.
Cancel	Closes the dialog box and discards all changes to the picture database.
Import...	Imports a picture from a picture file. The types of importable picture files include: BMP, JPG, GIF, and WMF.
Import From...	Imports pictures from a picture database (PDB) file.
Export...	Exports the current picture to a picture file.
Export To...	Exports the current selection to a picture database (PDB) file.
Add Group	Adds one picture group to the picture database.
Add Item	Imports a picture from a picture file and adds the picture to the current picture group.

Continued



Item	Description																
Add From...	Imports pictures from a picture database (PDB) file and adds those pictures to the current picture group.																
Move Up	Moves the selection down in the list																
Move Down	Moves the selection up in the list																
Delete	Delete the selection.																
Color Conversion	Select Dithering or Nearest Color as the color conversion method. If the color resolution of a picture is not compatible with the target panel, the application compiler will use the specified method to convert the picture data so it can be displayed without too much color distortion at runtime.																
Support Pressed Look	Available when the selection is a picture group. Check this item so the current picture group supports the pressed look. When a picture group supports the pressed look, it needs two pictures for each state; one picture is for the normal (released) look and another picture is for the pressed look.																
Transparent	<p>Check this item to enable the transparent feature of the selection; if the selection is a picture, the picture will be transparent for the specified transparent color; if the selection is a picture group, all the pictures of the picture group will be transparent for the specified transparent color. Note that this feature is effective only when a picture or a picture group is shown as the picture shape for an object.</p> <p>It is a common practice to make a picture transparent for a certain color so the picture can be shown as a non-rectangle shape. The following are some examples:</p> <table border="1"> <thead> <tr> <th>Original Picture</th> <th>Transparent Color</th> <th>Picture Shown</th> </tr> </thead> <tbody> <tr> <td></td> <td></td> <td></td> </tr> <tr> <td></td> <td></td> <td></td> </tr> <tr> <td></td> <td></td> <td></td> </tr> </tbody> </table>	Original Picture	Transparent Color	Picture Shown													
Original Picture	Transparent Color	Picture Shown															
																	
																	
																	
Transparent Color	Available when the Transparent item is checked. Select a color for the transparent color.																
Rename	Click this button to rename the current picture or the current picture group.																
Rotate/Flip	<p>Rotates or flips the current picture and saves it as another picture in the picture database. You can select one of the following 7 methods for the Rotate/Flip operation.</p> <table border="1"> <thead> <tr> <th>Method</th> <th>Description</th> </tr> </thead> <tbody> <tr> <td>90°</td> <td>Rotates the picture clockwise by 90 degree</td> </tr> <tr> <td>180°</td> <td>Rotates the picture clockwise by 180 degree</td> </tr> <tr> <td>270°</td> <td>Rotates the picture clockwise by 270 degree</td> </tr> <tr> <td>X</td> <td>Flips the picture over X axis</td> </tr> <tr> <td>90° &amp; X</td> <td>Rotates the picture clockwise by 90 degree and flips it over X Axis</td> </tr> <tr> <td>Y</td> <td>Flips the picture over Y axis</td> </tr> <tr> <td>90° &amp; Y</td> <td>Rotates the picture clockwise by 90 degree and flips it over Y Axis</td> </tr> </tbody> </table>	Method	Description	90°	Rotates the picture clockwise by 90 degree	180°	Rotates the picture clockwise by 180 degree	270°	Rotates the picture clockwise by 270 degree	X	Flips the picture over X axis	90° & X	Rotates the picture clockwise by 90 degree and flips it over X Axis	Y	Flips the picture over Y axis	90° & Y	Rotates the picture clockwise by 90 degree and flips it over Y Axis
Method	Description																
90°	Rotates the picture clockwise by 90 degree																
180°	Rotates the picture clockwise by 180 degree																
270°	Rotates the picture clockwise by 270 degree																
X	Flips the picture over X axis																
90° & X	Rotates the picture clockwise by 90 degree and flips it over X Axis																
Y	Flips the picture over Y axis																
90° & Y	Rotates the picture clockwise by 90 degree and flips it over Y Axis																



## 2.2.4. Sound Database

The sound database contains all the sounds used by the project. The sound database is empty initially after the project is created. Now only the target panel that is PM SCADA supports sound.

You can use a function button to play a sound or stop playing sound. For details, please see [Section 5.4.1 Basic Operations](#) of function buttons

You can use Execute General Command (\$C2.f) command flag setting in Command Block to play a sound. For details, please see [Section 3.6.7 Using General Commands](#).

### 2.2.4.1. Importing and Exporting Sounds

#### ■ Importing Sounds

You need to import a sound before you can use it for the project. There are two ways to import sounds:

- 1) Use the Sound Database dialog box to import one sound at a time from a sound file. The types of importable sound files include: WAV.
- 2) Use the Sound Database dialog box to import many sounds at a time from a sound database (SDB) file.

#### ■ Exporting Sounds

You can export the sounds of the project so the other projects can share those sounds by importing them. There are 2 ways to export sounds:

- 1) Use the Sound Database dialog box to export one sound at a time to a sound file.
- 2) Use the Sound Database dialog box to export many sounds at a time to a sound database (SDB) file.



### 2.2.4.2. Sound Database dialog box

The following is an example of the Sound Database dialog box.

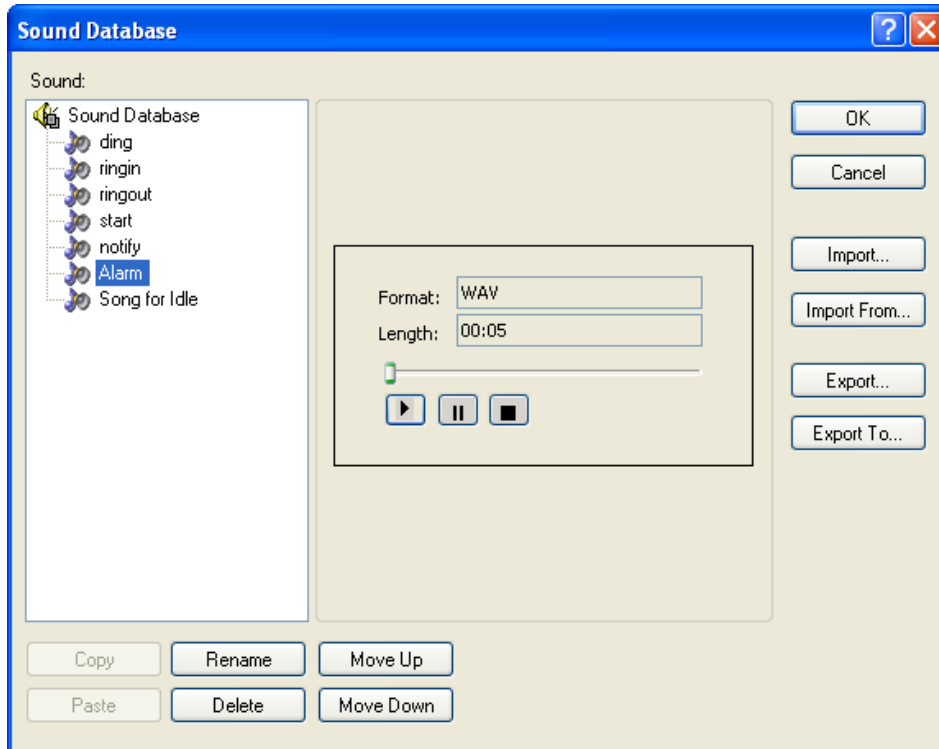

The following table describes how to read or use each of the items in the dialog box.

Item	Description
Sounds	Lists the sounds of the project. You can select a sound as the current selection. You can also make multiple selections.
Sound Information	Shows the sound information of the current selection such as sound format and the length. You can click  to start playing the sound. Click  to pause playing the sound. Click  to stop playing the sound.
OK	Closes the dialog box and accepts all changes to the sound database.
Cancel	Closes the dialog box and discards all changes to the sound database.
Import...	Imports a sound from a sound file. The types of importable sound files include: WAV.
Import From...	Imports sounds from a sound database (SDB) file.
Export...	Exports the current sound to a sound file.
Export To...	Exports the current selection to a sound database (SDB) file.
Rename	Click this button to rename the current sound.
Delete	Delete the selection.
Move Up	Moves the selection down in the list
Move Down	Moves the selection up in the list



## 2.2.5. Text Database

The Text Database is a dockable window. With the Text Database, you can manage the texts in multiple languages of your project easily. To open the Text Database, check the Text Database menu item in the Project menu or double click the Text Database node in the Global in PM Project Manager tool window.

The following is an example of the Text Database that lists the texts in all the languages of the project.

The screenshot shows the 'Text Database' window with a table containing the following data:

String ID	English	繁體中文	简体中文
A0001	General	一般設定	一般设定
A0002	Touch Panel	校正觸摸面板	校正触摸面板
A0003	Link 1	連線一	连接一
A0004	Link 2	連線二	连接二
A0005	Panel Setup	人機設置	人机设置
A0006	Run	運行	运行
A0007	Copy AP to HMI	複製應用到人機	复制应用到人机
A0008	Link 3	連線三	连接三
A0009	Link 4	連線四	连接四
A0010	Boot from File	從檔案運行應用	从文件运行应用
A0011	Update from File	從檔案更新應用	从文件更新应用
A0012	Copy AP to File	複製應用到檔案	复制应用到文件
A0013	FTP Site	FTP伺服器	FTP 服务器
A0014	Clear Recorded Data	清除記錄數據	清除记录数据
A0015	LAN Printer Address	網路印表機地址	网络打印机地址
A0016	Set Time/Date	設定萬年曆	设定万年历
A0017	Check Battery:	檢查電池:	检查电池:
A0018	False	否	否
A0019	True	是	是
A0020	Screen Saver Time (minutes):	螢幕保護時間(分):	屏幕保护时间(分):
A0021	Allow To Run Panel Setup:	允許執行人機設置程式:	允许执行人机设置程序:
A0022		開機後執行應用程序:	开机后执行应用程序:
A0023		網路印表機地址	网络打印机地址
A0024		增	增
A0025		減	減
A0026		減	減

Callouts in the image provide the following information:



- File to Table Icon**: Points to the icon for saving the table to a file.
- Table to File Icon**: Points to the icon for loading a table from a file.
- Table to Application Icon**: Points to the icon for saving the table to an application.
- Application to Table Icon**: Points to the icon for loading a table from an application.
- The name of the table. You can select a table from Table A to Table L.**: Points to the dropdown menu showing 'Table A'.
- To edit a text, you need to select a text row first by left-click anywhere in it, and then click the cell of the row to bring up the edit box. In the edit box, you can type the text.**: Points to the 'Allow To Run Panel Setup' row.
- To stop or confirm editing, you can click anywhere outside the selected row.**: Points to the area below the table.



To edit a text, you need to select a text row first by left-click anywhere in it, and then click the cell of the row to bring up the edit box. In the edit box, you can type the text.

To stop or confirm editing, you can click anywhere outside the selected row.

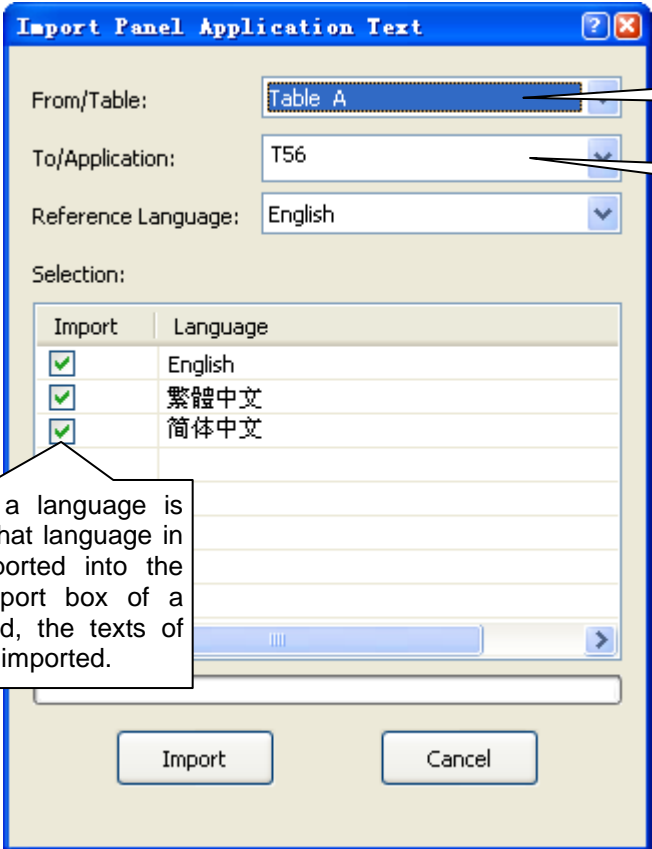

You can click the following icons to bring up the corresponding dialog box to import or export texts.

Icon	Description
	<p data-bbox="210 302 933 338">Imports texts from a text file(.txt file) to the selected the table.</p> <div data-bbox="379 338 1278 1176"> </div>
	<p data-bbox="210 1184 901 1220">Exports texts from the selected table to a text file (.txt file).</p> <div data-bbox="379 1220 1278 2033"> </div>

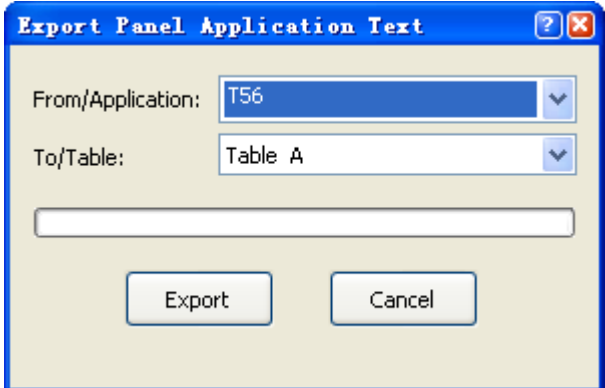
Icon	Description
	<p>Imports texts from the selected table to a panel application in the same project.</p>  <p>If the Import box of a language is checked, the texts of that language in the table will be imported into the application. If the Import box of a language is unchecked, the texts of that language won't be imported.</p>
	<p>Exports texts from a panel application of the project to the selected table.</p> 

You can right-click the Text Database to get the popup menu with the following menu items:

Menu Item	Description
Cut	Cut the selected text and put it on the Clipboard.
Copy	Copy the selected text and put it on the Clipboard.
Paste	Insert the text on the Clipboard to the current table.
Delete	Delete the selected text.
<Language name>	Check the language name to display the text of objects in the selected language.



## 2.3. Working with Tags

A tag represents a single input or output variable monitored or controlled by the system. By changing tags, you can use any PLC or controller without re-developing the application. This chapter explains how you can define and manage tags by tags editor.

After the tag is created in tags editor, you can use it in your application by Select Tag Dialog Box. Please see [Section 4.4.3.3 Selecting Tags](#) for details. Or you can specify the tag by yourself. The format of a tag is Link Number\Tag Group Name\Tag Name.

For example:

Tags	Description
1\MONITOR\CORE DISPLAY	Indicates a local tag named CORE DISPLAY in MONITOR tag group of link 1
0\BOT\DECLARE	Indicates a local tag named DECLARE in BOT tag group of internal memory
0\_ALARM SHOW	Indicates a global tag named _ALARM SHOW of internal memory

**Note** that the maximum text amount of the tag/tag group name is 48 characters. You are allowed to define not only tags for the link but also the tags for a tag group of the link.

### 2.3.1. Types of Tags

In PM designer, there are two types of tags: global tags and local tags.

#### ■ Global Tag

A global tag is a tag that can be used by all panel applications in the same project. With global tags, the panel applications in the same projects can share the common address declaration without having to keep and maintain the same set of tags locally.

**Note** that a global tag can be only associated with internal variables.

#### ■ Local Tag

A local tag is a tag that can be only used by the panel application which the tag is located in.

### 2.3.2. Opening and Closing Tags Editor

#### ■ Opening Tags Editor

To open the global tags editor, use the Global Tags... command on the Project menu, or double click Global > Global Tags item in the Project Manager tool window, or right-click the Global > Global Tags item in the Project Manager tool window to bring out the popup menu and then use the Open command on the popup menu.

To open the local tags editor, use the Tags... command on the Panel menu, or double click Panel Application > Tags item in the Project Manager tool window, or right-click the Panel Application > Tags item in the Project Manager tool window to bring out the popup menu and then use the Open command on the popup menu.

#### ■ Closing Tags Editor

To close the tag editor, select the window and click the close button, or choose Windows... on the Window menu, select the window you want to close in the window dialog and then click Close Window(s) button. You can also right-click the Global > Global Tags item (Panel Application > Tags item) in the Project Manager tool window to bring out the popup menu and then use the Close command on the popup menu to close the global tags editor(the local tags editor).



### 2.3.3. Creating Tags by Tags Editor

You can use tags editor to create and manage tags. The tags editor is split into two panes: Tag Group Explorer on the left and Tag List Window on the right. Each pane scrolls separately, both horizontally and vertically. You can position the mouse over the vertical splitter bar and drag the bar to resize the panes.

The following is an example of the tags editor.

The screenshot shows the 'Tags' application window. On the left is the 'Tag Group Explorer' showing a tree view of tag groups. On the right is the 'Tag List Window' displaying a table of tags for the selected 'MONITOR' group. A vertical splitter bar is located between the two panes. Callouts identify the 'Tag Group Explorer', 'Tag Groups', 'Vertical Splitter Bar', 'List all the Tags for the link', 'List all the Tags for the active tag group named MONITOR', and 'Tag List Window'.

	Name	Data Type	Address	Length	Scan Rate	Comment
1	CORE DISPLAY	32-Bit Unsigned Integer	QD512	n/a	Fast	CORE DISP...
2	START TIME	16-Bit Unsigned Integer	QW158	n/a	Fast	START TIME
3	CLM. TIME	16-Bit Unsigned Integer	QW159	n/a	Fast	CLOSE MOL...
4	REC. TIME	16-Bit Unsigned Integer	QW146	n/a	Fast	REC. TIME
5	SBK. TIME	16-Bit Unsigned Integer	QW133	n/a	Fast	SBK. TIME
6	OPM. TIME	16-Bit BCD	QW123	n/a	Fast	OPM. TIME
7	COOL TIME	32-Bit BCD	QD151	n/a	Fast	COOL TIME
8	CLOSE/OPEN BAR	16-Bit Signed Integer	IW23	n/a	Fast	
9	INJ/REC BAR	16-Bit Signed Integer	ID752	n/a	Fast	
10	light	ASCII String	C90	10	Normal	
11	CONTADOR	32-Bit Signed Integer	QD80	n/a	Fast	
12	DEFECTOS	32-Bit Signed Integer	QD200	n/a	Fast	
13	SCREW ROTATE	32-Bit Floating Point	VD56	n/a	Fast	
14	light 1	ASCII String	C200	20	Normal	
15	WSG 1	32-Bit Unsigned Integer	VD82	n/a	Fast	
16	light 2	ASCII String	C400	10	Normal	
17						

### 2.3.3.1. Tag Group Explorer

Tag explorer displays links, recipes, data loggers and their tag groups if any. From tags explorer, you can:

- Open a tag group of a link for editing by clicking the node
- Import and export tags of a link  
Described in [Section 2.3.4](#)
- Add new groups to a link and delete or rename the existing tag groups  
Described in [Section 2.3.5](#)
- View tags (Data Items) of recipes and data loggers.

If there are any recipes or data loggers in the application, the tag editor will display their data items as the tags. All the data items (tags) for the recipes or data loggers are read only in the tag editor. If you want to edit the data items (tags), please use the corresponding dialog box.

You can edit the data items of the selected recipe block with the recipe block dialog box. Please see [Section 10.5 Setting up Recipe Blocks](#) for details.

Tags Explorer	
mold(0)   mold(1)   machine i	
Name	
CR0:0	Item 0
CR0:1	Item 1
CR0:3	Item 2
CR0:4	Item 3
CR0:6	Item 4
CR0:7	Item 5
CR0:8	Item 6
CR0:9	Item 7

Recipe Block	
Data Item	
Addr.	Name
CR0:0	Item 0
CR0:1	Item 1
CR0:3	Item 2
CR0:4	Item 3
CR0:6	Item 4
CR0:7	Item 5
CR0:8	Item 6
CR0:9	Item 7

Recipe Block Name (ID)

Data Logger Name (ID)



### 2.3.3.2. Tag List Window

Tag list window displays all the tags related to selected tag group. In the tag list window, you can:

- Make switching between tag groups by clicking the window tab
- Click any column header to sort the list
- Add a tag by defining the tag name and then click any other cells to edit the elements of the tag

The following table describes each attribute of the tag.

Item	Description	
Name	Specifies the name for the tag. The name must be unique in the tag group. The maximum text amount of the name is 48 characters. And Chinese characters are supported. The name can not start with a number and can not be the same as a macro keyword. The name of global tags must start with underline ( _ ). But the name of the local tags can not start with underline ( _ ).	
Data Type	Selects the data type for the tag from the dropdown list. The supported data types for each tag are some of the followings: 16-Bit Unsigned Integer, 32-Bit Unsigned Integer, 16-Bit Signed Integer, 32-Bit Signed Integer, 16-Bit BCD, 32-Bit BCD, 32-Bit Floating Point, ASCII String, Bit.	
Address	<Edit Box>	Specifies the bit address when the Data Type is Bit, otherwise specifies the word address.
		Clicks this icon to bring up the Address Input Keypad and specify the desired address for the <Edit Box> field.
Length	Specifies the string length when the Data Type is ASCII string, otherwise displays n/a	
Scan Rate	Selects the scan rate for the tag from the dropdown list. The supported scan rates for each tag are Fast and Normal.	
Comment	Type a comment for the tag.	

- Cut, copy, paste and delete selected tags using menu commands or key combination

You can right-click the number column to display a popup menu of editing commands. The editing commands available depend on what the pointer is pointing to.

The following table shows the supported editing commands.

Menu Command	Key Combination	Description
<b>Cut</b>	CTRL+X	Removes selected tags from the active window and saves them to the Clipboard.
<b>Copy</b>	CTRL+C	Duplicates selected tags in the active window.
<b>Paste</b>	CTRL+V	Pastes cut or copied tags into an active window.
<b>Delete</b>	DELETE	Deletes tags without copying it to the Clipboard.

**Note** that all editing commands require a selection in order to work. To select a tag, click the row on its header number column. To select multiple tags, click the row on its header column and use Ctrl+Click to add a row to the selection.





### 2.3.4. Importing and Exporting Tags

#### ■ Importing Tags

- 1) Right-click the Internal Memory or a link or any of their tag groups item in the Tag Group Explorer to bring out the popup menu and then use the Import Tags... command on the popup menu.
- 2) Click the \*.csv file you want to import. If you want to open a tags import file that was saved in a different folder, locate and open the folder first.
- 3) Click Open.

**Note:** If the file format is not correct, the import operation will be cancelled.

**Note:** The tags import file can contain tags only or many tag groups and their tags.

**Note:** If the name of a tag in the file exists in the tag group, you will be asked to confirm whether to replace the existing tag or not.

- If selecting Yes, the tag in the tag group will be replaced by the tag from the file.
- If selecting No, only the tag with nonexistent name will be imported.
- If selecting Cancel, the import operation will be cancelled.

**Note:** If the tag group name in the file exists in the link, you will be asked to confirm whether to replace the existing tag group or not.

- If selecting Yes, the tags in the existing tag group will be removed and replaced by the tags from the file.
- If selecting No, only the tag group with nonexistent name and its tags will be imported.
- If selecting Cancel, the import operation will be cancelled.

#### ■ Exporting Tags

If you have tags you want to reuse in another application panel, you can export the tags of the selected tag group as a .csv file. You may do the following:

- 1) Locate the tag group you would like to export
- 2) Right-click on the tag group to display the item's "popup menu"; and then click Export Tags..., the second menu item.
- 3) If you want to save tags in a different folder, locate and open the folder first. then click Save.

You can export all the tags of the internal memory or a link as a .csv file by right-clicking on the internal memory or a link item and then using the Export All Tags command on the popup menu.

### 2.3.5. Adding/Deleting/Renaming Tag Groups

#### ■ Adding a Tag Group

- 1) Click the link or the internal memory you want to add a tag group for
- 2) Right-click the selected item to display the popup menu, and then click Add Group menu
- 3) The new tag group will be added at the end of the link. And the default tag group name will become selected for renaming.

#### ■ Deleting a Tag Group:

- 1) Locate the tag group you would like to delete
- 2) Right-click on the tag group to display the popup menu; and then click Delete Group

**Note:** You can only select one tag group to delete at one time.

#### ■ Renaming a Tag Group:

- 1) Locate the tag group you would like to rename
- 2) Right-click on the tag group to display the popup menu; and then click Rename Group or click the tag group
- 3) The tag group name will become selected, simply type the new name over the selected text, and then press the ENTER key or click anywhere outside the editing field.

## CHAPTER 3

# CREATING PANEL APPLICATIONS





<b>3.1. Setting up the Panel Application .....</b>	<b>1</b>
3.1.1. General Settings .....	2
3.1.2. Custom Settings.....	6
<b>3.2. Working with Keys .....</b>	<b>8</b>
3.2.1. Default Settings for the Panel Application .....	9
3.2.2. Settings for a Screen.....	10
3.2.3. Key Usage Table Settings .....	11
3.2.4. Usage Settings for a Key .....	12
<b>3.3. Internal Memory.....</b>	<b>16</b>
3.3.1. Types of Internal Memory.....	16
3.3.2. Index Registers .....	16
3.3.3. System Memory .....	17
3.3.4. Setting up Internal Memory .....	19
<b>3.4. Communication Links .....</b>	<b>20</b>
3.4.1. Types of Communication Links .....	20
3.4.2. General Settings .....	23
3.4.3. Parameter Settings (Serial Port) .....	26
3.4.4. Parameter Settings (Ethernet Port).....	27
3.4.5. Sub-link Settings .....	28
3.4.6. Sharing Data among Panels Using Data Sharer .....	29
<b>3.5. Sound Table .....</b>	<b>30</b>
<b>3.6. Command Block and Status Words .....</b>	<b>32</b>
3.6.1. Types of Command Block and Status Words .....	32
3.6.2. General Settings .....	37
3.6.3. Command Block Settings (Type A) .....	38
3.6.4. Status Word Settings (Type A) .....	41
3.6.5. Command Block Settings (Type H) .....	42
3.6.6. Status Word Settings (Type H).....	44
3.6.7. Using General Commands.....	45
<b>3.7. Setting up Clock Operations.....</b>	<b>47</b>

<b>3.8. Setting up Passwords .....</b>	<b>50</b>
<b>3.9. Screens .....</b>	<b>51</b>
3.9.1.Types of Screens .....	51
3.9.2.Creating and Opening Screens.....	52
3.9.3.Setting up a Screen.....	53
3.9.4.Importing/Exporting a Screen.....	58
3.9.5.Cutting/Copying/Pasting/Deleting a Screen .....	58
3.9.6.Saving Screens as Pictures .....	59



## Setting up the Panel Application

You can set up the panel application with the General Setup dialog box. There are five ways to open the dialog box:

- 1) In the PM Designer's Project Manager tool window, double-click the Panel Application node (  ).
- 2) In the PM Designer's Project Manager tool window, right-click the Panel Application node (  ) to bring out the popup menu and select General Setup menu item.
- 3) In the PM Designer's Project Manager tool window, double-click the General Setup Node (  ) in Panel Application > Setup
- 4) In the PM Designer's Project Manager tool window, right-click the General Setup Node (  ) in Panel Application > Setup to bring out the popup menu and select Properties menu item.
- 5) In the PM Designer's menu bar, click Panel to bring up the Panel sub-menu. Click General Setup...in the Panel sub-menu.

The General Setup dialog box contains the following pages. Some of the pages appear only when they are needed.

- **General**

Described in [Section 3.1.1](#).

- **Custom**

Described in [Section 3.1.2](#).

- **Keys**

Described in [Section 3.1.3](#).

- **Startup Macro / Main Macro / Event Macro / Time Macro**

Described in [Section 14.2.6](#).

### 3.1.1. General Settings

This section describes how to define the general settings for a panel application. The following is an example of the General page of the General Setup dialog box.

The screenshot shows the 'General Setup' dialog box with the following settings:

- Application Name:** MMI AP Demo
- Model:** MT104-VNT (Ethernet)
- Battery Backed RAM:** 1 MB
- Flash ROM:** 128 MB
- Start Up:**
  - Screen: 1
  - Delay Time: 0 second(s)
  - Language: Language 1
  - Default User Level: 8
- Idle Processing:**
  - Display Idle Screen:
  - Screen Saver Time: 20 minutes
- Buzzer Sounding Time:** 0.5 seconds
- Macro:**
  - Startup Macro:
  - Main Macro:  Delay Time: 50 milli-second(s)
  - Event Macro #1:  Trigger bit: (None)
  - Event Macro #2:  Trigger bit: MemStkInserted
  - Event Macro #3:  Trigger bit: MemStkRemoved
  - Event Macro #4:  Trigger bit: BatteryLow
  - Time Macro #1:  Time Interval: 0.5 second
  - Time Macro #2:  Time Interval: 10 seconds
  - Time Macro #3:  Time Interval: 20 minutes
  - Time Macro #4:  Time Interval: 8 hours
- Print:**
  - Printer: (None)
- Overlapped buttons can be activated in sequence by one touch:**
- Note:** MMI AP Demo

Buttons at the bottom: 確定 (OK), 取消 (Cancel), 説明 (Help)

The following table describes each item in the General page.

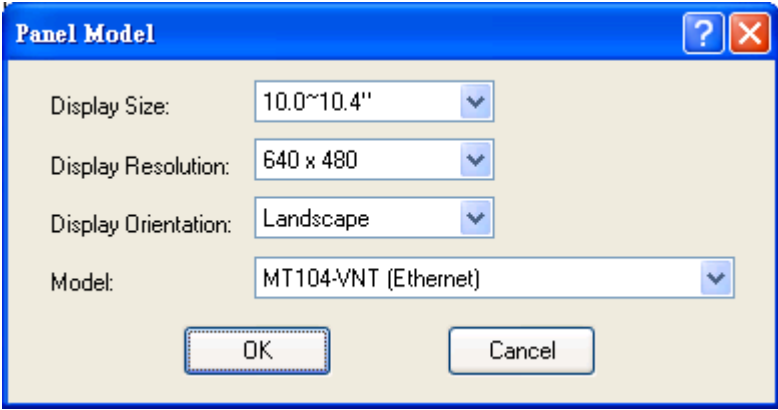
Item		Description
Application Name		The name of the panel application.
Model		<p>The model of the target panel.</p> <p>Click  to bring up the Panel Model dialog box which helps you to select a model by specifying the size, resolution and orientation of the display.</p> <p>The following is a sample of Panel Model dialog box</p> 
Battery Backed RAM		Specifies the size of the battery backed RAM installed in the target panel.
Use External Keypad		<p>Available if the target panel supports the custom designed external keypad. For example MT-037-LSK, MT-037V-LSK, ML037-LSK...</p> <p>Select this option if the application uses a custom designed external keypad.</p>
Start Up	Screen	Specifies the first screen of the application that the target panel will display after power up.
	Delay Time	Specifies the time that the target panel will delay to run the application.
	Display Countdown	Check this option if you want the target panel to display countdown while it is waiting for the expiry of the Delay Time.
	Language	Specifies the language that the application will display the text for after power up.
	Login Required	Check this option if you want the target panel to get a valid password from the operator before it displays the first screen.
	Default User Level	Available when the Login Required is not selected. Specifies the user level as the initial user level for the application. When the target panel starts the application, it sets the current user level to the initial user level.
Idle Processing	Display Idle Screen	Check this option if you want the target panel to display the Idle Screen when the target panel has not been operated by the operator for the specified amount of time. The specified amount of time is called the idle time.
	Idle Time	The amount of time that will be used to decide if the idle screen should be displayed.
	Idle Screen	Specifies the screen that will be displayed as the idle screen.
	Change User Level	Check this option if you want the target panel to change the current user level when the idle screen is displayed.
	Idle User Level	Available when the Change User Level is selected. Specifies the user level that will be the current user level when the idle screen is displayed.
	Screen Saver Time	Specifies the screen saver time. The target panel will turn off its backlight when it has not been operated by the operator for the specified amount of time.

Continued



Item		Description														
Buzzer Sounding Time		Specifies the length of the beep sounded by the buzzer when a touch operation is activated.														
Overlapped buttons can be activated in sequence by one touch		Check this option if you want the application to have the feature that the overlapped buttons can be activated in sequence by one touch. This feature allows the operator to issue multiple data settings or commands with one touch. There are some constraints using this feature. See <a href="#">Section 3.1.1.1</a> for details.														
Note		You can type a note for the panel application.														
Macro	Startup Macro	Check this item if you want the application to have the Startup macro. The Startup macro is run only once when the application starts. The target panel will not display the start-up screen until the macro terminates. You can use Startup macro to initialize global data and settings for your application.														
	Main Macro	Check this item if you want the application to have the Main macro. The Main macro is run all the time while the application is running. The target panel runs the Main macro cyclically, i.e. it runs Main macro starting from the first command again each time after it completes the processing of the last command of the macro or when it encounters an END command in the middle of the macro.														
	Event Macro #1~#4	An Event macro is run whenever the associated trigger bit changes from 0 (Off) to 1 (On). An application can have up to four Event macros. If the application needs an Event macro for a certain event, check one of the items that are available and specify the associated trigger bit for the corresponding Event macro.														
	Time Macro #1~#4	<p>A Time macro is run periodically with a preset time interval. An application can have up to four Time macros. Each Time macro has a different set of time intervals you can choose to specify how often you want it to run. The following table describes the available time intervals for each Time macro.</p> <table border="1"> <thead> <tr> <th>Time Macro</th> <th>Available Time Intervals</th> <th>Remark</th> </tr> </thead> <tbody> <tr> <td>#1</td> <td>0.5 and 1 second</td> <td></td> </tr> <tr> <td>#2</td> <td>1, 2, 3, ... and 59 seconds</td> <td></td> </tr> <tr> <td>#3</td> <td>1, 2, 3, ... and 59 minutes</td> <td>The macro is run at 0 second.</td> </tr> <tr> <td>#4</td> <td>1, 2, 3, ... and 24 hours</td> <td>The macro is run on the clock.</td> </tr> </tbody> </table> <p>If the application needs a Time macro, check the item of an appropriate Time macro and specify the time interval for that Time macro.</p>	Time Macro	Available Time Intervals	Remark	#1	0.5 and 1 second		#2	1, 2, 3, ... and 59 seconds		#3	1, 2, 3, ... and 59 minutes	The macro is run at 0 second.	#4	1, 2, 3, ... and 24 hours
Time Macro	Available Time Intervals	Remark														
#1	0.5 and 1 second															
#2	1, 2, 3, ... and 59 seconds															
#3	1, 2, 3, ... and 59 minutes	The macro is run at 0 second.														
#4	1, 2, 3, ... and 24 hours	The macro is run on the clock.														
Print	Printer	Specifies the type of printer that the application will use.														
	Port	Specifies the port of the target panel that will connect to the printer.														



### 3.1.1.1. Activating Multiple Overlapped Buttons by One Touch

To enable the feature of activating multiple overlapped buttons by one touch, open the Panel General Setup dialog box and check the option of “Activate multiple overlapped buttons by one touch” on the General page. With this feature, the overlapped underlying buttons will be activated one by one from top to bottom when the top-most button is pressed. The following are the constraints of applying this feature.

1. The types of buttons that support this feature include: Bit Button, Toggle Switch, Screen Button, Function Button, Word Button, Multi-state Switch, and Keypad Button.
2. The first button, i.e. the top-most button, can only be a bit button, a toggle switch, a word button, a multi-state switch, or a keypad button. The button can not have the optional property of Minimum Hold Time or Operator Confirmation. If the button is a bit button, a toggle switch, or a keypad button, it can not have any macro. If the button is a word button, it can not be configured for Enter Value or Enter Password. If the button is a multi-state switch, it can not be configured as a List or Drop-down List.
3. The underlying buttons that have the optional property of Minimum Hold Time or Operator Confirmation will not be activated.
4. An underlying bit button that is configured for Momentary ON or Momentary OFF will not be activated. However if that bit button is the second button and the first button is a keypad button, it can be activated. An underlying bit button that has any macro will not be activated.
5. An underlying toggle switch that has any macro will not be activated.
6. An underlying multi-state switch that is configured as a List or Drop-down List will not be activated.
7. A function button can only be the last button, i.e. the bottom-most button. All the buttons that are under a function button will not be activated.
8. A screen button can only be the last button. All the buttons that are under a screen button will not be activated.
9. A word button that is configured for Enter Value or Enter Password can only be the last button. All the buttons that are under such button will not be activated.
10. The maximal number of buttons that can be indirectly activated by one touch is 10.



### 3.1.2. Custom Settings

This section describes how to define the customization settings for a panel application. The following is an example of the Custom page of the General Setup dialog box.

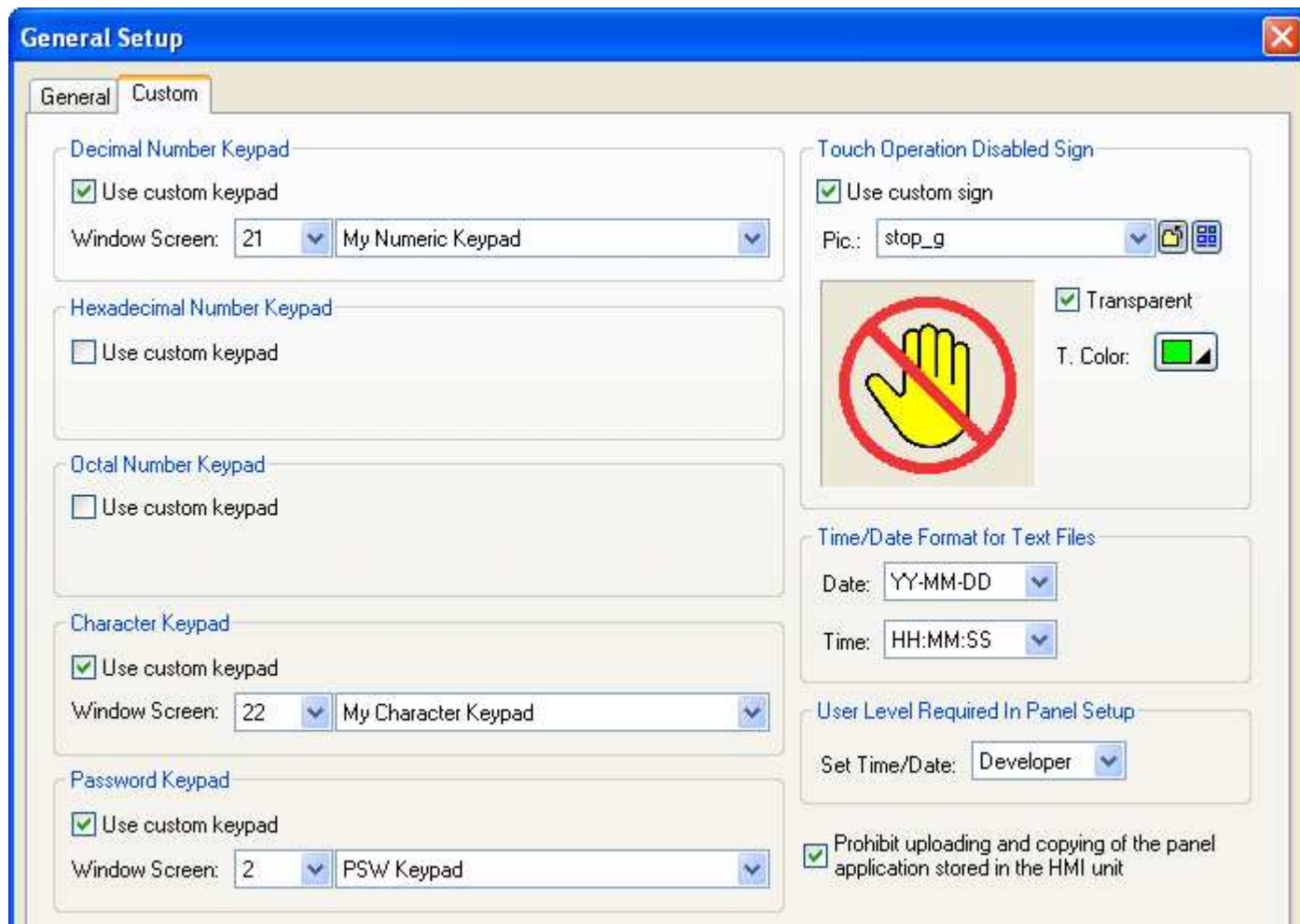

The following table describes each item in the Custom page.

Item		Description
Decimal Number Keypad	Use custom keypad	Check this item if you want the application to use the custom keypad instead of the built-in keypad for the entry of decimal numbers.
	Window Screen	Specify the window screen that is designed as the decimal number keypad.
Hexadecimal Number Keypad	Use custom keypad	Check this item if you want the application to use the custom keypad instead of the built-in keypad for the entry of hexadecimal numbers.
	Window Screen	Specify the window screen that is designed as the hexadecimal number keypad.
Octal Number Keypad	Use custom keypad	Check this item if you want the application to use the custom keypad instead of the built-in keypad for the entry of octal numbers.
	Window Screen	Specify the window screen that is designed as the octal number keypad.

Continued



Item		Description
Character Keypad	Use custom keypad	Check this item if you want the application to use the custom keypad instead of the built-in keypad for the entry of characters.
	Window Screen	Specify the window screen that is designed as the character keypad.
Password Keypad	Use custom keypad	Check this item if you want the application to use the custom keypad instead of the built-in keypad for the entry of passwords.
	Window Screen	Specify the window screen that is designed as the password keypad.
Touch Operation Disabled Sign	Use custom sign	Check this item if you want the application to display the custom sign instead of the built-in sign when the touch operation of an object is disabled.
	Picture	Specify the picture that is to replace the built-in sign.
	Transparent	Select this item if you want parts of the custom sign to be transparent.
	T. Color	Specify the transparent color.
Time/Date Format for Text Files	Date	The date format that the target panel will use to output date information to text files.
	Time	The time format that the target panel will use to output time information to text files.
User Level Required in Panel Setup	Set Time/Date	The minimum user level that is required to set the time and date of the target panel through the target panel's Panel Setup menu.
Prohibit uploading and copying of the panel application stored in the HMI unit		Check this option if you want to prohibit uploading and copying of the panel application stored in the HMI unit.



## 3.2. Working with Keys

Some of the target panels are key type. Those key type panels carry external keys that you can press to perform the defined operations.

To assign or change the operation of the keys in the panel application, you can use the following two ways:

- **Default Settings for the Panel Application**  
Described in [Section 3.2.1](#).
- **Settings for a Screen**  
Described in [Section 3.2.2](#).



### 3.2.1. Default Settings for the Panel Application

The default settings are the settings that can be used by all screens in the panel application. With the default settings of the keys, all the screens in the panel application can share the common usages of the keys and do not have to keep and maintain the same usages in each screen.

You can do the default settings of the keys for the panel application in General Setup property sheet. To open the General Setup property sheet, please see [Section 3.1 Setting up the Panel Application](#) for details. The General Setup property sheet provides you the Keys page to set up the keys as default.

The following is an example of the Keys page and Usage Setup dialog in General Setup property sheet.

The screenshot shows the 'General Setup' dialog box with the 'Keys' tab selected. It contains a 'Key Usage Table' and a 'Usage Setup Dialog' for key K22.

Key	Usage	Usage(Esc +)
UP	None	None
DOWN	None	None
F1	None	None
F2	None	None
F3	None	None
F4	None	None
F5	None	None
F6	None	None
K20	None	None
K21	None	None
K22	Bit Button	None
K23	None	None
K24	None	None
K25	None	None
K26	None	None
K27	None	None
K30	None	None
K31	None	None
K32	None	None

The 'Usage Setup Dialog' for K22 shows the following configuration:

- Usage: Bit Button
- Function:  Invert
- Write Address: 1\M238
- Advanced options:
  - Enabled by Bit
  - Enabled by User Level
  - Operator Confirmation
  - Notification

If all the screens use the default settings of the key named K22, the K22 key will perform just like the bit button when it is pressed. That means in any screen at runtime, the state of 1\M238 bit will be inverted when the K22 Key is pressed.

There are two parts in the above illustration: Key Usage Table and Usage Setup Dialog.

#### ■ Key Usage Table

A table lists all the keys of the target panel and their default usages. The key usage table here is empty (Usages for key and key combination are none) initially after the panel application is created. For details about Key Usage Table, please see [Section 3.2.3](#)

#### ■ Usage Setup Dialog

A floating dialog box allows you specify the usage for the selected key or key combination. You can left-click the cell in the key usage table to bring up the dialog. For details about Usage Setup Dialog, please see [Section 3.2.4](#).

### 3.2.2. Settings for a Screen

Each screen can have its own key operation. If you want a key to perform an operation only in the specified screen, you need to do the settings of the keys for the screen in Screen Properties property sheet. To open the Screen Properties property sheet, please see [Section 3.9.3 Setting up a Screen](#) for details. The Screen Properties property sheet provides you the Keys page to set up the keys for the screen.

The following is an example of the Keys page and Usage Setup dialog in Screen Properties property sheet.

The screenshot shows the 'Screen Properties' dialog box with the 'Keys' tab selected. It contains a 'Key Usage Table' and an 'Usage Setup Dialog' for the F5 key.

Key	Usage	Usage(Esc +)
UP	None	None
DOWN	None	None
F1	Bit Button	None
F2	Screen Button	None
F3	Bit Button	None
F4	Bit Button	None
F5	<b>Screen Button</b>	None
F6	None	None
K20	None	None
K21	None	None
K22	Bit Button	None
K23	None	None
K24	None	None
K25	None	None
K26	None	None
K27	None	None
K30	None	None
K31	None	None
K32	None	None

The 'Usage Setup Dialog' for the F5 key is open, showing the following settings:

- Use Default
- Usage: Screen Button
- Screen Button:
  - Function:  Open Screen,  Previous Screen,  Close & Open Screen,  Close Screen
  - Screen: 253, Technical Support
  - Change user level to:
  - Acknowledge alarm
- Advanced:
  - Enabled by Bit
  - Enabled by User Level
  - Notification

F5 key will perform just like the screen button when it is pressed. That means at runtime, the screen 253 will be opened when the F5 Key is pressed in the specified screen.

There are two parts in the above illustration: Key Usage Table and Usage Setup Dialog.

#### ■ Key Usage Table

A table lists all the keys of the target panel and their usages in a screen. The key usage table here is the same as the one in the Keys page of the General Setup property sheet initially after the screen is created. For details about Key Usage Table, please see [Section 3.2.3](#)

#### ■ Usage Setup Dialog

A floating dialog box allows you specify the usage for the selected key or key combination. You can left-click the cell in the key usage table to bring up the dialog. In the dialog box, Use Default option is checked by default. You can uncheck the Use Default option to assign a usage for the selected cell and such usage is only available in the specified screen. For details about Usage Setup Dialog, please see [Section 3.2.4](#).



### 3.2.3. Key Usage Table Settings

The key usage table is located in the Keys page of General Setup property sheet or Screen Properties property sheet. It lists all the keys of the target panel and their default usages. The Keys page is only shown up when the target panel is key type.

The following table lists key type panels and their available keys.

Model	Available Keys
MT-037-LSK MT-037V-LSK ML-037-LSK	Provides UP,DOWN F1~F4 by default; Provides UP,DOWN,F1~F6,K20~K37 if using external keypad; Provides ESC-key to double the number of above keys.
MT-057-LSK , MT-057V-LSK , ML-057-LSK MT-057-TSK , MT-57V-TSK , ML-057-TSK	Provides UP,DOWN,F1~F6,K20~K37 Provides ESC-key to double the number of above keys.
MT-070-WST , MT-070-WKT	Provides F1~F6
PM SCADA	Provides F1~F12

The following is an example of key usage table in the Keys page.

Key	Usage	Usage(Esc +)
UP	None	None
DOWN	None	None
F1	Bit Button	None
F2	Screen Button	None
F3	Bit Button	None
F4	Bit Button	None
F5	Screen Button	None
F6	None	None
K20	None	None
K21	None	None
K22	Bit Button	None
K23	None	None
K24	None	None
K25	None	None
K26	None	None
K27	None	None
K30	None	None
K31	None	None
K32	None	None

There are three columns in the key usage table. The following table describes each column.

Column	Description
Key	Available keys of the target panel.
Usage	Displays how the key will be used when it is pressed.
Usage(Esc+)	Displays how the key combination (ESC+Key) will be used when it is pressed. This column exists only when the target panel supports the key combination.

**Note:** Left-click the cell will bring up the Usage Setup Dialog which is used to set up the usage of the selected cell. For details about Usage Setup Dialog, please see [Section 3.2.4.](#)

### 3.2.4. Usage Settings for a Key

You can assign or change the usage for the key or the key combination by Usage Setup Dialog. The Usage Setup dialog is a floating dialog box that can be moved to anywhere you want.

To open the Usage Setup Dialog, you may left-click the cell in the key usage table. If the selection in the key usage table is changed, the dialog box will stay open and show all the settings related to the selection.

The following is an example of usage setup dialog.

The name of the key or the key combination







If you want to close the dialog, click the close button.

Property	Description										
Use Default	Check this option if you want to use the default setting in the Keys page of the General Setup property sheet. The field is only available in the Keys page of the Screen Properties property sheet.										
Usage	Select a usage for the key or key combination. There are 7 choices: None, Bit Button, Function Button, Keypad Button, Multistate Switch, Screen Button and Word Button.										
Bit Button	<p>If the usage is Bit Button, you need to specify the following properties:</p> <table border="1"> <thead> <tr> <th>Property</th> <th>Description</th> </tr> </thead> <tbody> <tr> <td>Function</td> <td>Select the operation for the bit button. There are 5 choices: Set ON, Set OFF, Momentary ON, Momentary OFF, and Invert. For details, see <a href="#">Section 5.1.1 Basic Operations</a></td> </tr> <tr> <td>Write Address</td> <td>Specifies the bit variable to be operated. Click  to enter an address for this field. Click  to select a tag for this field.</td> </tr> <tr> <td>ON Macro</td> <td>Check this option if you want the button to have an ON macro. Select a macro from the dropdown list. This option is available when the bit button operation is Set ON, Momentary ON, or Momentary OFF.</td> </tr> <tr> <td>OFF Macro</td> <td>Check this option if you want the button to have an OFF macro. Select a macro from the dropdown list. This option is available when the bit button operation is Set OFF, Momentary ON, or Momentary OFF.</td> </tr> </tbody> </table>	Property	Description	Function	Select the operation for the bit button. There are 5 choices: Set ON, Set OFF, Momentary ON, Momentary OFF, and Invert. For details, see <a href="#">Section 5.1.1 Basic Operations</a>	Write Address	Specifies the bit variable to be operated. Click  to enter an address for this field. Click  to select a tag for this field.	ON Macro	Check this option if you want the button to have an ON macro. Select a macro from the dropdown list. This option is available when the bit button operation is Set ON, Momentary ON, or Momentary OFF.	OFF Macro	Check this option if you want the button to have an OFF macro. Select a macro from the dropdown list. This option is available when the bit button operation is Set OFF, Momentary ON, or Momentary OFF.
Property	Description										
Function	Select the operation for the bit button. There are 5 choices: Set ON, Set OFF, Momentary ON, Momentary OFF, and Invert. For details, see <a href="#">Section 5.1.1 Basic Operations</a>										
Write Address	Specifies the bit variable to be operated. Click  to enter an address for this field. Click  to select a tag for this field.										
ON Macro	Check this option if you want the button to have an ON macro. Select a macro from the dropdown list. This option is available when the bit button operation is Set ON, Momentary ON, or Momentary OFF.										
OFF Macro	Check this option if you want the button to have an OFF macro. Select a macro from the dropdown list. This option is available when the bit button operation is Set OFF, Momentary ON, or Momentary OFF.										

Continued











Property	Description																					
Function Button	If the usage is Function Button, you need to specify the following properties:																					
	<table border="1"> <thead> <tr> <th>Property</th> <th>Description</th> </tr> </thead> <tbody> <tr> <td>Function</td> <td>Specifies the operation that you want the function button to perform. About the available operations, see <a href="#">Section 5.4.1 Basic Operation</a>.</td> </tr> </tbody> </table>	Property	Description	Function	Specifies the operation that you want the function button to perform. About the available operations, see <a href="#">Section 5.4.1 Basic Operation</a> .																	
Property	Description																					
Function	Specifies the operation that you want the function button to perform. About the available operations, see <a href="#">Section 5.4.1 Basic Operation</a> .																					
Keypad Button	If the usage is Keypad Button, you need to specify the following properties:																					
	<table border="1"> <thead> <tr> <th>Property</th> <th>Description</th> </tr> </thead> <tbody> <tr> <td>Enter Character</td> <td>Select this item if the button is used to input the specified character to the keypad buffer.</td> </tr> <tr> <td>Character</td> <td>Available when the Enter Character is selected. Specifies the character to be entered in the keypad buffer.</td> </tr> <tr> <td>Enter Command</td> <td>Select this item if the button is used to issue the specified command to the keypad buffer.</td> </tr> <tr> <td rowspan="5">Command</td> <td>Available when the Enter Command is selected. Specifies the command to be issued to the keypad buffer. There are four commands available:</td> </tr> <tr> <td> <table border="1"> <thead> <tr> <th>Command</th> <th>Description</th> </tr> </thead> <tbody> <tr> <td>Enter</td> <td>Completes the data entry and sends the input string to the associated object or the system.</td> </tr> <tr> <td>Escape</td> <td>Cancels the data entry operation.</td> </tr> <tr> <td>Clear</td> <td>Clears the keypad buffer.</td> </tr> <tr> <td>Backspace</td> <td>Removes the last character in the keypad buffer.</td> </tr> </tbody> </table> </td> </tr> </tbody> </table>	Property	Description	Enter Character	Select this item if the button is used to input the specified character to the keypad buffer.	Character	Available when the Enter Character is selected. Specifies the character to be entered in the keypad buffer.	Enter Command	Select this item if the button is used to issue the specified command to the keypad buffer.	Command	Available when the Enter Command is selected. Specifies the command to be issued to the keypad buffer. There are four commands available:	<table border="1"> <thead> <tr> <th>Command</th> <th>Description</th> </tr> </thead> <tbody> <tr> <td>Enter</td> <td>Completes the data entry and sends the input string to the associated object or the system.</td> </tr> <tr> <td>Escape</td> <td>Cancels the data entry operation.</td> </tr> <tr> <td>Clear</td> <td>Clears the keypad buffer.</td> </tr> <tr> <td>Backspace</td> <td>Removes the last character in the keypad buffer.</td> </tr> </tbody> </table>	Command	Description	Enter	Completes the data entry and sends the input string to the associated object or the system.	Escape	Cancels the data entry operation.	Clear	Clears the keypad buffer.	Backspace	Removes the last character in the keypad buffer.
	Property	Description																				
	Enter Character	Select this item if the button is used to input the specified character to the keypad buffer.																				
	Character	Available when the Enter Character is selected. Specifies the character to be entered in the keypad buffer.																				
	Enter Command	Select this item if the button is used to issue the specified command to the keypad buffer.																				
	Command	Available when the Enter Command is selected. Specifies the command to be issued to the keypad buffer. There are four commands available:																				
<table border="1"> <thead> <tr> <th>Command</th> <th>Description</th> </tr> </thead> <tbody> <tr> <td>Enter</td> <td>Completes the data entry and sends the input string to the associated object or the system.</td> </tr> <tr> <td>Escape</td> <td>Cancels the data entry operation.</td> </tr> <tr> <td>Clear</td> <td>Clears the keypad buffer.</td> </tr> <tr> <td>Backspace</td> <td>Removes the last character in the keypad buffer.</td> </tr> </tbody> </table>		Command	Description	Enter	Completes the data entry and sends the input string to the associated object or the system.	Escape	Cancels the data entry operation.	Clear	Clears the keypad buffer.	Backspace	Removes the last character in the keypad buffer.											
Command		Description																				
Enter		Completes the data entry and sends the input string to the associated object or the system.																				
Escape		Cancels the data entry operation.																				
Clear	Clears the keypad buffer.																					
Backspace	Removes the last character in the keypad buffer.																					
Multistate Switch	If the usage is Multistate Switch, you need to specify the following properties:																					
	<table border="1"> <thead> <tr> <th>Property</th> <th>Description</th> </tr> </thead> <tbody> <tr> <td>State Type</td> <td>The state type of the monitored variable. There are two options: Value and LSB. For details, see <a href="#">Section 4.4.1.1 State Types</a></td> </tr> <tr> <td>Data Type</td> <td>The data type of the variables specified in this page.</td> </tr> <tr> <td>Write Address</td> <td>Specifies the variable to be controlled. Click  to enter an address for this field. Click  to select a tag for this field.</td> </tr> <tr> <td>Total State</td> <td>Specifies the number of valid states that the monitored variable has. <b>Note:</b> The last state is state N-1 when the Total States is N.</td> </tr> <tr> <td>Next State</td> <td>Specifies the method of calculating the next state for the Button control type. +1 means the next state is the current state plus one when the current state is not the last state. When the current state is the last state, the next state is state 0. -1 means the next state is the current state minus one when the current state is not state 0. When the current state is state 0, the next state is the last state.</td> </tr> </tbody> </table>	Property	Description	State Type	The state type of the monitored variable. There are two options: Value and LSB. For details, see <a href="#">Section 4.4.1.1 State Types</a>	Data Type	The data type of the variables specified in this page.	Write Address	Specifies the variable to be controlled. Click  to enter an address for this field. Click  to select a tag for this field.	Total State	Specifies the number of valid states that the monitored variable has. <b>Note:</b> The last state is state N-1 when the Total States is N.	Next State	Specifies the method of calculating the next state for the Button control type. +1 means the next state is the current state plus one when the current state is not the last state. When the current state is the last state, the next state is state 0. -1 means the next state is the current state minus one when the current state is not state 0. When the current state is state 0, the next state is the last state.									
	Property	Description																				
	State Type	The state type of the monitored variable. There are two options: Value and LSB. For details, see <a href="#">Section 4.4.1.1 State Types</a>																				
	Data Type	The data type of the variables specified in this page.																				
	Write Address	Specifies the variable to be controlled. Click  to enter an address for this field. Click  to select a tag for this field.																				
	Total State	Specifies the number of valid states that the monitored variable has. <b>Note:</b> The last state is state N-1 when the Total States is N.																				
Next State	Specifies the method of calculating the next state for the Button control type. +1 means the next state is the current state plus one when the current state is not the last state. When the current state is the last state, the next state is state 0. -1 means the next state is the current state minus one when the current state is not state 0. When the current state is state 0, the next state is the last state.																					
Screen Button	If the usage is Screen Button, you need to specify the following properties:																					
	<table border="1"> <thead> <tr> <th>Property</th> <th>Description</th> </tr> </thead> <tbody> <tr> <td>Function</td> <td>Specifies the operation that you want the screen button to perform. There are four choices: Open Screen, Previous Screen, Close and Open Screen, and Close Screen. For details, see <a href="#">Section 5.3.1 Basic Operations</a>.</td> </tr> <tr> <td>Screen</td> <td>Specifies the screen to be opened.</td> </tr> <tr> <td>Change user level to</td> <td>Check this option if you want the button to change the current user level. And specifies the new user level to replace the current user level.</td> </tr> <tr> <td>Acknowledge alarm</td> <td>Check this option if you want the button to acknowledge the associated alarm of the screen where the button is on.</td> </tr> </tbody> </table>	Property	Description	Function	Specifies the operation that you want the screen button to perform. There are four choices: Open Screen, Previous Screen, Close and Open Screen, and Close Screen. For details, see <a href="#">Section 5.3.1 Basic Operations</a> .	Screen	Specifies the screen to be opened.	Change user level to	Check this option if you want the button to change the current user level. And specifies the new user level to replace the current user level.	Acknowledge alarm	Check this option if you want the button to acknowledge the associated alarm of the screen where the button is on.											
	Property	Description																				
	Function	Specifies the operation that you want the screen button to perform. There are four choices: Open Screen, Previous Screen, Close and Open Screen, and Close Screen. For details, see <a href="#">Section 5.3.1 Basic Operations</a> .																				
	Screen	Specifies the screen to be opened.																				
Change user level to	Check this option if you want the button to change the current user level. And specifies the new user level to replace the current user level.																					
Acknowledge alarm	Check this option if you want the button to acknowledge the associated alarm of the screen where the button is on.																					

Continued











Property	Description																																																		
Word Button	<p>If the usage is Word Button, you need to specify the following properties:</p> <table border="1" data-bbox="295 302 1468 1644"> <thead> <tr> <th data-bbox="295 302 502 340">Property</th> <th data-bbox="502 302 1468 340">Description</th> </tr> </thead> <tbody> <tr> <td data-bbox="295 340 502 414">Function</td> <td data-bbox="502 340 1468 414">Specifies the operation that the word button performs. For details, <a href="#">see Section 5.6.1 Basic Operations.</a></td> </tr> <tr> <td data-bbox="295 414 502 459">Data Type</td> <td data-bbox="502 414 1468 459">The data type of the variable to be controlled.</td> </tr> <tr> <td data-bbox="295 459 502 582">Write Address</td> <td data-bbox="502 459 1468 582">Specifies the variable to be controlled. Click  to enter an address for this field. Click  to select a tag for this field.</td> </tr> <tr> <td data-bbox="295 582 502 627">Constant</td> <td data-bbox="502 582 1468 627">The constant for the specified operation.</td> </tr> <tr> <td data-bbox="295 627 502 672">Minimum</td> <td data-bbox="502 627 1468 672">The minimum for the specified operation.</td> </tr> <tr> <td data-bbox="295 672 502 716">Maximum</td> <td data-bbox="502 672 1468 716">The maximum for the specified operation.</td> </tr> <tr> <td data-bbox="295 716 502 784">Total Digits</td> <td data-bbox="502 716 1468 784">The number of digits to be displayed for the Minimum and the Maximum on the numeric keypad.</td> </tr> <tr> <td data-bbox="295 784 502 1534">Fractional Digits</td> <td data-bbox="502 784 1468 1534"> <p>When the Data Type is 32-bit Floating Point, this property specifies the number of fractional digits to be displayed for the Minimum and the Maximum on the numeric keypad.</p> <p>When the Data Type is not 32-bit Floating Point, this property specifies not only the number of fractional digits to be displayed but also the number of least significant digits to be displayed as the fractional part. With this feature, an integer can be shown and entered as a fixed point number. When the Fractional Digits is nonzero, say N, the entered value will be converted to an integer according to the following formula before being output.  <math display="block">\text{OutputValue} = \text{EnteredValue} * (\text{Nth power of } 10)</math> <b>Example:</b></p> <table border="1" data-bbox="518 1142 1452 1534"> <thead> <tr> <th data-bbox="518 1142 813 1220">Display Type</th> <th data-bbox="813 1142 981 1220">Total Digits</th> <th data-bbox="981 1142 1149 1220">Fractional Digits</th> <th data-bbox="1149 1142 1292 1220">Entered Value</th> <th data-bbox="1292 1142 1452 1220">Output Value</th> </tr> </thead> <tbody> <tr> <td data-bbox="518 1220 813 1265">32-bit Floating Point</td> <td data-bbox="813 1220 981 1265">4</td> <td data-bbox="981 1220 1149 1265">2</td> <td data-bbox="1149 1220 1292 1265">12.34</td> <td data-bbox="1292 1220 1452 1265">12.34</td> </tr> <tr> <td data-bbox="518 1265 813 1310">32-bit Floating Point</td> <td data-bbox="813 1265 981 1310">4</td> <td data-bbox="981 1265 1149 1310">2</td> <td data-bbox="1149 1265 1292 1310">123.4</td> <td data-bbox="1292 1265 1452 1310">Error!</td> </tr> <tr> <td data-bbox="518 1310 813 1388">16-bit Signed Decimal</td> <td data-bbox="813 1310 981 1388">5</td> <td data-bbox="981 1310 1149 1388">2</td> <td data-bbox="1149 1310 1292 1388">123.45</td> <td data-bbox="1292 1310 1452 1388">12345</td> </tr> <tr> <td data-bbox="518 1388 813 1467">16-bit Signed Decimal</td> <td data-bbox="813 1388 981 1467">5</td> <td data-bbox="981 1388 1149 1467">2</td> <td data-bbox="1149 1388 1292 1467">-0.05</td> <td data-bbox="1292 1388 1452 1467">-5</td> </tr> <tr> <td data-bbox="518 1467 813 1534">16-bit Signed Decimal</td> <td data-bbox="813 1467 981 1534">5</td> <td data-bbox="981 1467 1149 1534">2</td> <td data-bbox="1149 1467 1292 1534">3</td> <td data-bbox="1292 1467 1452 1534">300</td> </tr> </tbody> </table> </td> </tr> <tr> <td data-bbox="295 1534 502 1644">Activation</td> <td data-bbox="502 1534 1468 1644">Select Button Down item so the touch operation will be activated when the button is touched. Select this Button Up item so the touch operation will be activated when the button is released.</td> </tr> </tbody> </table>	Property	Description	Function	Specifies the operation that the word button performs. For details, <a href="#">see Section 5.6.1 Basic Operations.</a>	Data Type	The data type of the variable to be controlled.	Write Address	Specifies the variable to be controlled. Click  to enter an address for this field. Click  to select a tag for this field.	Constant	The constant for the specified operation.	Minimum	The minimum for the specified operation.	Maximum	The maximum for the specified operation.	Total Digits	The number of digits to be displayed for the Minimum and the Maximum on the numeric keypad.	Fractional Digits	<p>When the Data Type is 32-bit Floating Point, this property specifies the number of fractional digits to be displayed for the Minimum and the Maximum on the numeric keypad.</p> <p>When the Data Type is not 32-bit Floating Point, this property specifies not only the number of fractional digits to be displayed but also the number of least significant digits to be displayed as the fractional part. With this feature, an integer can be shown and entered as a fixed point number. When the Fractional Digits is nonzero, say N, the entered value will be converted to an integer according to the following formula before being output.  <math display="block">\text{OutputValue} = \text{EnteredValue} * (\text{Nth power of } 10)</math> <b>Example:</b></p> <table border="1" data-bbox="518 1142 1452 1534"> <thead> <tr> <th data-bbox="518 1142 813 1220">Display Type</th> <th data-bbox="813 1142 981 1220">Total Digits</th> <th data-bbox="981 1142 1149 1220">Fractional Digits</th> <th data-bbox="1149 1142 1292 1220">Entered Value</th> <th data-bbox="1292 1142 1452 1220">Output Value</th> </tr> </thead> <tbody> <tr> <td data-bbox="518 1220 813 1265">32-bit Floating Point</td> <td data-bbox="813 1220 981 1265">4</td> <td data-bbox="981 1220 1149 1265">2</td> <td data-bbox="1149 1220 1292 1265">12.34</td> <td data-bbox="1292 1220 1452 1265">12.34</td> </tr> <tr> <td data-bbox="518 1265 813 1310">32-bit Floating Point</td> <td data-bbox="813 1265 981 1310">4</td> <td data-bbox="981 1265 1149 1310">2</td> <td data-bbox="1149 1265 1292 1310">123.4</td> <td data-bbox="1292 1265 1452 1310">Error!</td> </tr> <tr> <td data-bbox="518 1310 813 1388">16-bit Signed Decimal</td> <td data-bbox="813 1310 981 1388">5</td> <td data-bbox="981 1310 1149 1388">2</td> <td data-bbox="1149 1310 1292 1388">123.45</td> <td data-bbox="1292 1310 1452 1388">12345</td> </tr> <tr> <td data-bbox="518 1388 813 1467">16-bit Signed Decimal</td> <td data-bbox="813 1388 981 1467">5</td> <td data-bbox="981 1388 1149 1467">2</td> <td data-bbox="1149 1388 1292 1467">-0.05</td> <td data-bbox="1292 1388 1452 1467">-5</td> </tr> <tr> <td data-bbox="518 1467 813 1534">16-bit Signed Decimal</td> <td data-bbox="813 1467 981 1534">5</td> <td data-bbox="981 1467 1149 1534">2</td> <td data-bbox="1149 1467 1292 1534">3</td> <td data-bbox="1292 1467 1452 1534">300</td> </tr> </tbody> </table>	Display Type	Total Digits	Fractional Digits	Entered Value	Output Value	32-bit Floating Point	4	2	12.34	12.34	32-bit Floating Point	4	2	123.4	Error!	16-bit Signed Decimal	5	2	123.45	12345	16-bit Signed Decimal	5	2	-0.05	-5	16-bit Signed Decimal	5	2	3	300	Activation	Select Button Down item so the touch operation will be activated when the button is touched. Select this Button Up item so the touch operation will be activated when the button is released.
Property	Description																																																		
Function	Specifies the operation that the word button performs. For details, <a href="#">see Section 5.6.1 Basic Operations.</a>																																																		
Data Type	The data type of the variable to be controlled.																																																		
Write Address	Specifies the variable to be controlled. Click  to enter an address for this field. Click  to select a tag for this field.																																																		
Constant	The constant for the specified operation.																																																		
Minimum	The minimum for the specified operation.																																																		
Maximum	The maximum for the specified operation.																																																		
Total Digits	The number of digits to be displayed for the Minimum and the Maximum on the numeric keypad.																																																		
Fractional Digits	<p>When the Data Type is 32-bit Floating Point, this property specifies the number of fractional digits to be displayed for the Minimum and the Maximum on the numeric keypad.</p> <p>When the Data Type is not 32-bit Floating Point, this property specifies not only the number of fractional digits to be displayed but also the number of least significant digits to be displayed as the fractional part. With this feature, an integer can be shown and entered as a fixed point number. When the Fractional Digits is nonzero, say N, the entered value will be converted to an integer according to the following formula before being output.  <math display="block">\text{OutputValue} = \text{EnteredValue} * (\text{Nth power of } 10)</math> <b>Example:</b></p> <table border="1" data-bbox="518 1142 1452 1534"> <thead> <tr> <th data-bbox="518 1142 813 1220">Display Type</th> <th data-bbox="813 1142 981 1220">Total Digits</th> <th data-bbox="981 1142 1149 1220">Fractional Digits</th> <th data-bbox="1149 1142 1292 1220">Entered Value</th> <th data-bbox="1292 1142 1452 1220">Output Value</th> </tr> </thead> <tbody> <tr> <td data-bbox="518 1220 813 1265">32-bit Floating Point</td> <td data-bbox="813 1220 981 1265">4</td> <td data-bbox="981 1220 1149 1265">2</td> <td data-bbox="1149 1220 1292 1265">12.34</td> <td data-bbox="1292 1220 1452 1265">12.34</td> </tr> <tr> <td data-bbox="518 1265 813 1310">32-bit Floating Point</td> <td data-bbox="813 1265 981 1310">4</td> <td data-bbox="981 1265 1149 1310">2</td> <td data-bbox="1149 1265 1292 1310">123.4</td> <td data-bbox="1292 1265 1452 1310">Error!</td> </tr> <tr> <td data-bbox="518 1310 813 1388">16-bit Signed Decimal</td> <td data-bbox="813 1310 981 1388">5</td> <td data-bbox="981 1310 1149 1388">2</td> <td data-bbox="1149 1310 1292 1388">123.45</td> <td data-bbox="1292 1310 1452 1388">12345</td> </tr> <tr> <td data-bbox="518 1388 813 1467">16-bit Signed Decimal</td> <td data-bbox="813 1388 981 1467">5</td> <td data-bbox="981 1388 1149 1467">2</td> <td data-bbox="1149 1388 1292 1467">-0.05</td> <td data-bbox="1292 1388 1452 1467">-5</td> </tr> <tr> <td data-bbox="518 1467 813 1534">16-bit Signed Decimal</td> <td data-bbox="813 1467 981 1534">5</td> <td data-bbox="981 1467 1149 1534">2</td> <td data-bbox="1149 1467 1292 1534">3</td> <td data-bbox="1292 1467 1452 1534">300</td> </tr> </tbody> </table>	Display Type	Total Digits	Fractional Digits	Entered Value	Output Value	32-bit Floating Point	4	2	12.34	12.34	32-bit Floating Point	4	2	123.4	Error!	16-bit Signed Decimal	5	2	123.45	12345	16-bit Signed Decimal	5	2	-0.05	-5	16-bit Signed Decimal	5	2	3	300																				
Display Type	Total Digits	Fractional Digits	Entered Value	Output Value																																															
32-bit Floating Point	4	2	12.34	12.34																																															
32-bit Floating Point	4	2	123.4	Error!																																															
16-bit Signed Decimal	5	2	123.45	12345																																															
16-bit Signed Decimal	5	2	-0.05	-5																																															
16-bit Signed Decimal	5	2	3	300																																															
Activation	Select Button Down item so the touch operation will be activated when the button is touched. Select this Button Up item so the touch operation will be activated when the button is released.																																																		

Continued



Property	Description																						
Advanced	<p>The following table describes each property in the Advanced group. Some of the properties are available when need.</p> <table border="1" data-bbox="296 315 1469 1200"> <thead> <tr> <th data-bbox="296 315 491 353">Property</th> <th data-bbox="491 315 1469 353">Description</th> </tr> </thead> <tbody> <tr> <td data-bbox="296 353 491 427">Enabled by Bit</td> <td data-bbox="491 353 1469 427">Check this option so the operation of the object will be enabled and disabled by the specified bit.</td> </tr> <tr> <td data-bbox="296 427 491 521">Bit</td> <td data-bbox="491 427 1469 521">Specifies the bit that enables and disables the touch operation. Click  to enter a bit address. Click  to select a bit tag.</td> </tr> <tr> <td data-bbox="296 521 491 595">Enabling State</td> <td data-bbox="491 521 1469 595">Specifies the state (On or Off) that enables the touch operation.</td> </tr> <tr> <td data-bbox="296 595 491 669">Enabled by User Level</td> <td data-bbox="491 595 1469 669">Check this item so the touch operation of the object will be enabled and disabled by the current user level.</td> </tr> <tr> <td data-bbox="296 669 491 763">Lowest Enabling User Level</td> <td data-bbox="491 669 1469 763">Specifies the lowest user level that is required to enable the touch operation.</td> </tr> <tr> <td data-bbox="296 763 491 936">Operator Confirmation</td> <td data-bbox="491 763 1469 936">Check this option if you want the operator to confirm the operation. The Confirmation box will be displayed when the object performs the operation. If the operator selects “Yes” in the Confirmation box, the operation will be done. If the operator selects “No” or the operator does not respond within the specified time period (Maximum Waiting Time), the operation will be cancelled.</td> </tr> <tr> <td data-bbox="296 936 491 1030">Maximum Waiting Time</td> <td data-bbox="491 936 1469 1030">Specifies the maximum time that the object will wait for the operator’s confirmation. The operation will be cancelled if the operator does not respond within this time.</td> </tr> <tr> <td data-bbox="296 1030 491 1104">Notification</td> <td data-bbox="491 1030 1469 1104">Check this option so the object will notify the specified bit after it finishes the operation.</td> </tr> <tr> <td data-bbox="296 1104 491 1142">Bit</td> <td data-bbox="491 1104 1469 1142">Specifies the bit that receives the notification.</td> </tr> <tr> <td data-bbox="296 1142 491 1200">State</td> <td data-bbox="491 1142 1469 1200">Specifies the state (On or Off) that is used for the notification.</td> </tr> </tbody> </table>	Property	Description	Enabled by Bit	Check this option so the operation of the object will be enabled and disabled by the specified bit.	Bit	Specifies the bit that enables and disables the touch operation. Click  to enter a bit address. Click  to select a bit tag.	Enabling State	Specifies the state (On or Off) that enables the touch operation.	Enabled by User Level	Check this item so the touch operation of the object will be enabled and disabled by the current user level.	Lowest Enabling User Level	Specifies the lowest user level that is required to enable the touch operation.	Operator Confirmation	Check this option if you want the operator to confirm the operation. The Confirmation box will be displayed when the object performs the operation. If the operator selects “Yes” in the Confirmation box, the operation will be done. If the operator selects “No” or the operator does not respond within the specified time period (Maximum Waiting Time), the operation will be cancelled.	Maximum Waiting Time	Specifies the maximum time that the object will wait for the operator’s confirmation. The operation will be cancelled if the operator does not respond within this time.	Notification	Check this option so the object will notify the specified bit after it finishes the operation.	Bit	Specifies the bit that receives the notification.	State	Specifies the state (On or Off) that is used for the notification.
Property	Description																						
Enabled by Bit	Check this option so the operation of the object will be enabled and disabled by the specified bit.																						
Bit	Specifies the bit that enables and disables the touch operation. Click  to enter a bit address. Click  to select a bit tag.																						
Enabling State	Specifies the state (On or Off) that enables the touch operation.																						
Enabled by User Level	Check this item so the touch operation of the object will be enabled and disabled by the current user level.																						
Lowest Enabling User Level	Specifies the lowest user level that is required to enable the touch operation.																						
Operator Confirmation	Check this option if you want the operator to confirm the operation. The Confirmation box will be displayed when the object performs the operation. If the operator selects “Yes” in the Confirmation box, the operation will be done. If the operator selects “No” or the operator does not respond within the specified time period (Maximum Waiting Time), the operation will be cancelled.																						
Maximum Waiting Time	Specifies the maximum time that the object will wait for the operator’s confirmation. The operation will be cancelled if the operator does not respond within this time.																						
Notification	Check this option so the object will notify the specified bit after it finishes the operation.																						
Bit	Specifies the bit that receives the notification.																						
State	Specifies the state (On or Off) that is used for the notification.																						



### 3.3. Internal Memory

This section describes how to set up and use the internal memory for the panel application.

#### 3.3.1. Types of Internal Memory

The following table describes the types of memory space that can exist or always exist in the internal memory.

Type	Address Format	Description
Regular user memory	Word: \$Un Bit: \$Un.b; b: 0~f	The size of this memory space is settable.
Battery backed user memory	Word: \$Nn Bit: \$Nn.b; b: 0~f	This memory space is available when the target panel is equipped with battery backed RAM. The size of this memory space is settable.
System memory	Word: \$Sn Bit: \$Sn.b; b: 0~f	This memory space keeps the system maintained data and information. See <a href="#">Section 3.3.3</a> for details.
Index registers	Word: \$In Bit: \$In.b; b: 0~f	The index registers are provided to support the indirect addressing. To know how to specify indirect address by using index register, please see <a href="#">Section 3.3.2</a> for details.
Command block	Word: \$CBn Bit: \$CBn.b; b: 0~f	This memory space is allocated for storing the data read from the specified command block.

#### 3.3.2. Index Registers

The index registers are battery backed if the panel has battery backed memory. The index registers are cleared to zero when the panel application is updated.

You can use the index registers to specify the indirect address. With the support of indirect addressing, an object or macro can be designed to access different sets of data at run time.

##### Examples

- 1) The word address  $W[\$I30]$  is equivalent to  $W2000$  when the value of  $\$I30$  is 2000.
- 2) The word address  $\$U[\$I0+123]$  is equivalent to  $\$U223$  when the value of  $\$I0$  is 100.
- 3) The bit address  $\$U[\$I2].a$  is equivalent to  $\$U0.a$  when the value of  $\$I2$  is 0.
- 4) The word address  $[\$I2]:W100$  is equivalent to  $3:W100$  when the value of  $\$I2$  is 3.
- 5) The bit address  $[\$I0]:W[\$I1+10].f$  is equivalent to  $5:W20.f$  when the values of  $\$I0$  and  $\$I1$  are 5 and 10 respectively.

##### Notes:

- 1) It is your responsibility to make sure that the values in the index registers will result in valid addresses at runtime. PM Designer has no way to check the validity of the using of index registers.
- 2) The offset values must be a positive number and the maximum offset value is 65535.
- 3) Only  $\$I0$ ~ $\$I15$  can be used for the node address (PLC address) and no offset value is allowed.
- 4) Make sure the PLC driver you are going to use supports the indirect addressing.



### 3.3.3. System Memory

The following table lists the system maintained data and information in the system memory of the MT panels that may be useful for your application.

**Note** that in any case do not modify the system memory for any purpose or the system may malfunction or crash.

Address	Length	Content
\$S0~\$S25	26	Keypad input buffer for keypads \$S0: Command code for keypad display \$S1~\$S24: Null terminated ASCII character string up to 48 characters
\$S42	1	The second and minute of the current time in BCD format Bit 0~7: Second (0x00~0x59) Bit 8~15: Minute (0x00~0x59)
\$S43	1	The hour of the current time in BCD format and the RTC adjustment parameter Bit 0~7: Hour (0x00~0x23) Bit 8~15: RTC adjustment value
\$S44	1	The day and month of the current date in BCD format Bit 0~7: Day (0x01~0x31) Bit 8~15: Month (0x01~0x12)
\$S45	1	The year and the day-of-week of the current date in BCD format Bit 0~7: Year (0x00~0x99) Bit 8~15: Day of week (0x00~0x06); 0 represents Sunday
\$S46	1	The second of the current time in binary format (0~59)
\$S47	1	The minute of the current time in binary format (0~59)
\$S48	1	The hour of the current time in binary format (0~23)
\$S49	1	The one tenth of the second of the current time in binary format (0~9) 9 represents 0.9 second
\$S50	1	The day of the current date in binary format (0~30) 0 represents the first day of a month
\$S51	1	The month of the current date in binary format (0~11) 0 represents January
\$S52	1	The year of the current date in binary format (0~99)
\$S53	1	The day of week of the current date in binary format (0~6) 0 represents Sunday
\$S219	1	Current user level (0~9); 9 indicates that the user logged in with the developer password
\$S230~\$S241	12	The ASCII character string up to 24 characters to show the allowable input range for numeric keypads
\$S297	1	The lowest user level that can be accepted by the current password keypad. When the value is 0, any user level is acceptable. When the value is 9, only the developer password is acceptable.
\$S300~\$S301	2	500ms timer
\$S302~\$S303	2	1 second timer
\$S304	1	20 Hz sine wave (-1000 ~ 1000)
\$S305	1	20 Hz cosine wave (-1000 ~ 1000)
\$S306	1	20 Hz triangle wave (0~1000)



Continued



Address	Length	Content																																																								
\$S307	1	System signals \$\$S307.0: always 0 when ready \$\$S307.1: always 1 when ready																																																								
\$S315	1	System status \$\$S315.0: 1 indicates that the data in battery backed RAM is good																																																								
\$S317	1	Current language number (0~9); 0 represents language #1																																																								
\$S319	1	Status bits of USB memory sticks \$\$S319.0: Drive C (1:OK; 0:None) \$\$S319.1: Drive D (1:OK; 0:None) \$\$S319.2: Drive E (1:OK; 0:None)																																																								
\$S654	1	Link enabled bits for Link 1~16 \$\$S654.0 is for Link 1; 0: Disabled; 1: Enabled \$\$S654.1 1 is for Link 2; ... \$\$S654.f is for Link 16																																																								
662~\$S677	32	Communication status words for Link 1~16 \$\$S662 is for Link 1 \$\$S663 is for Link 2 ... \$\$S677 is for Link 16  Communication Status <table border="1"> <thead> <tr> <th>Value</th> <th>Meaning</th> <th>Value</th> <th>Meaning</th> </tr> </thead> <tbody> <tr> <td>0</td> <td>OK</td> <td>13</td> <td>Invalid request</td> </tr> <tr> <td>1</td> <td>Overrun error</td> <td>14</td> <td>Device busy</td> </tr> <tr> <td>2</td> <td>Break error</td> <td>15</td> <td>Unknown error</td> </tr> <tr> <td>3</td> <td>Parity error</td> <td>16</td> <td>Link disabled</td> </tr> <tr> <td>4</td> <td>Framing error</td> <td>17</td> <td>Initialization failure</td> </tr> <tr> <td>5</td> <td>No response</td> <td>18</td> <td>Failed to send data</td> </tr> <tr> <td>6</td> <td>Unrecognized response</td> <td>19</td> <td>Failed to receive data</td> </tr> <tr> <td>7</td> <td>Timeout</td> <td>20</td> <td>Failed to open connection</td> </tr> <tr> <td>8</td> <td>Inactive CTS</td> <td>21</td> <td>Connection not ready</td> </tr> <tr> <td>9</td> <td>Checksum error</td> <td>22</td> <td>Invalid sub-link</td> </tr> <tr> <td>10</td> <td>Command rejected</td> <td>23</td> <td>Invalid COM port</td> </tr> <tr> <td>11</td> <td>Invalid address</td> <td>24</td> <td>Error</td> </tr> <tr> <td>12</td> <td>Invalid range</td> <td>255</td> <td>Uncertain</td> </tr> </tbody> </table>	Value	Meaning	Value	Meaning	0	OK	13	Invalid request	1	Overrun error	14	Device busy	2	Break error	15	Unknown error	3	Parity error	16	Link disabled	4	Framing error	17	Initialization failure	5	No response	18	Failed to send data	6	Unrecognized response	19	Failed to receive data	7	Timeout	20	Failed to open connection	8	Inactive CTS	21	Connection not ready	9	Checksum error	22	Invalid sub-link	10	Command rejected	23	Invalid COM port	11	Invalid address	24	Error	12	Invalid range	255	Uncertain
Value	Meaning	Value	Meaning																																																							
0	OK	13	Invalid request																																																							
1	Overrun error	14	Device busy																																																							
2	Break error	15	Unknown error																																																							
3	Parity error	16	Link disabled																																																							
4	Framing error	17	Initialization failure																																																							
5	No response	18	Failed to send data																																																							
6	Unrecognized response	19	Failed to receive data																																																							
7	Timeout	20	Failed to open connection																																																							
8	Inactive CTS	21	Connection not ready																																																							
9	Checksum error	22	Invalid sub-link																																																							
10	Command rejected	23	Invalid COM port																																																							
11	Invalid address	24	Error																																																							
12	Invalid range	255	Uncertain																																																							
\$S838	1	The ID of the current recipe block (0~15)																																																								
\$S839~\$S854	16	The current recipe numbers of recipe block 0~15 \$\$S839 is for recipe block 0 \$\$S840 is for recipe block 1 ... \$\$S854 is for recipe block 15																																																								

### 3.3.4. Setting up Internal Memory

You can use the Internal Memory dialog box to define the sizes of the regular user memory and the battery backed user memory. To open the Internal Memory dialog box, you can do one of followings:

- 1) In the PM Designer's Project Manager tool window, double-click the Internal Memory Node (  ) in Panel Application > Links
- 2) In the PM Designer's Project Manager tool window, right-click the Internal Memory Node (  ) in Panel Application > Links to bring out the popup menu and select Properties menu item.

The following is an example of the Internal Memory dialog box.

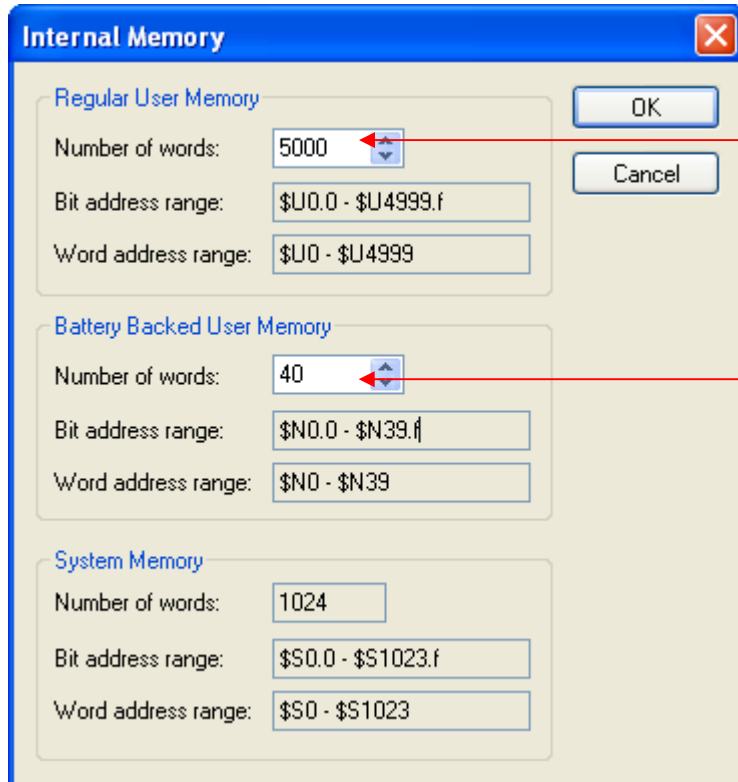

Specify the size of regular user memory in word. The size must be between 0 and 131072 words. By default, it is 5000.

Specify the size of battery backed user memory in word. The size must be between 0 and 131072 words. By default, it is 0.

## 3.4. Communication Links

This section describes how to set up communication links for the panel application to access the data of external devices.

### 3.4.1. Types of Communication Links

The following table describes the three types of communication links that the panel application can have.

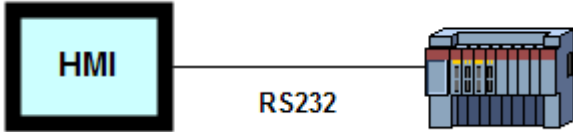
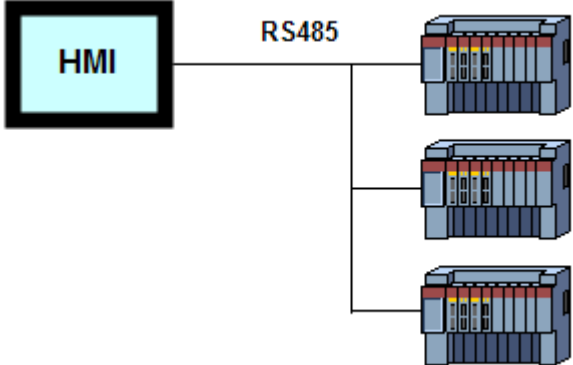
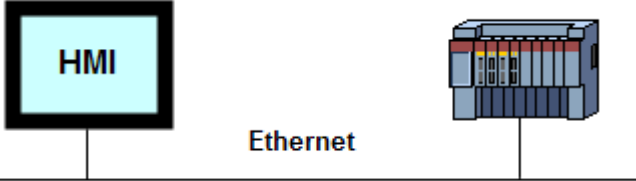
Link Type	Description
Direct link	<p data-bbox="328 629 1437 689">A direct link connects the panel and the specified device or devices directly. The following are examples of the direct links.</p> <p data-bbox="328 757 1394 786"><b>[Example 1]</b> The panel uses an RS232 direct link to talk with the specified device directly.</p>  <p data-bbox="328 1016 1406 1046"><b>[Example 2]</b> The panel uses an RS485 direct link to talk with the specified devices directly.</p>  <p data-bbox="328 1476 1414 1505"><b>[Example 3]</b> The panel uses an Ethernet direct link to talk with the specified device directly.</p> 

Continued

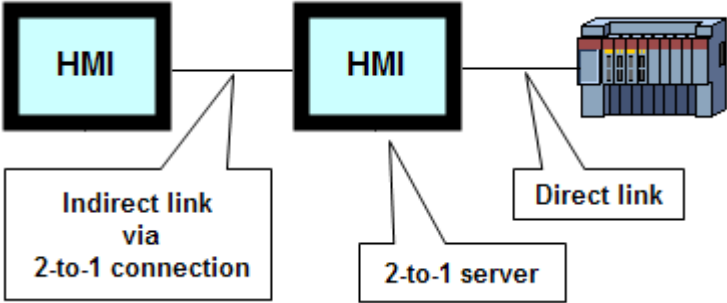
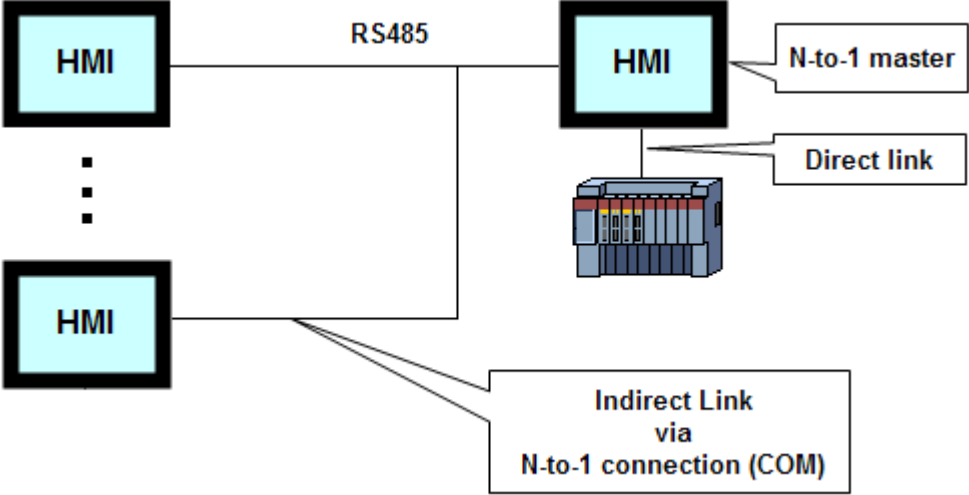
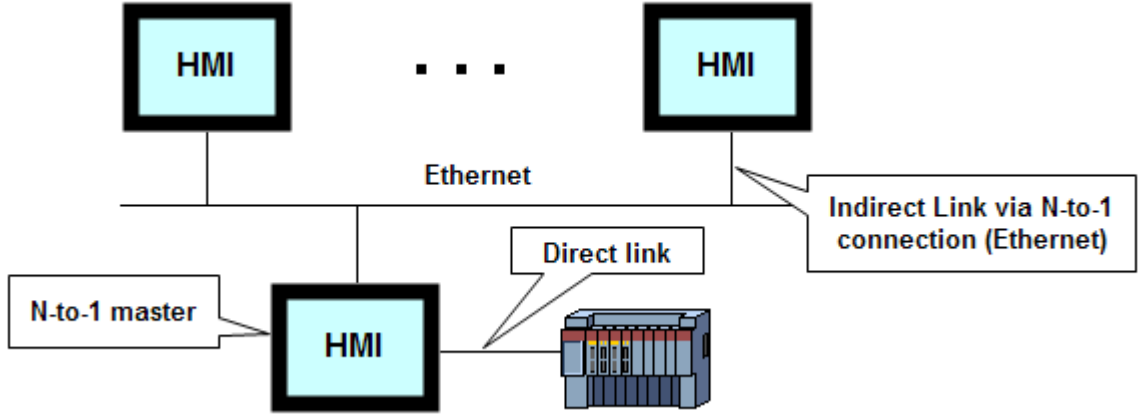

Link Type	Description
<p>Indirect link</p>	<p>With an indirect link, the panel can talk with a device that is not connected to it. An indirect link connects the panel and the specified indirect link server. The indirect link server is the target panel application of the same project and connects to the specified device directly.</p> <p><b>[Example 1] Indirect Link via 2-to-1 Connection</b></p>  <p><b>[Example 2] Indirect Link via N-to-1 Connection (COM)</b></p>  <p><b>[Example 3] Indirect Link via N-to-1 Connection (Ethernet)</b></p> 

Continued



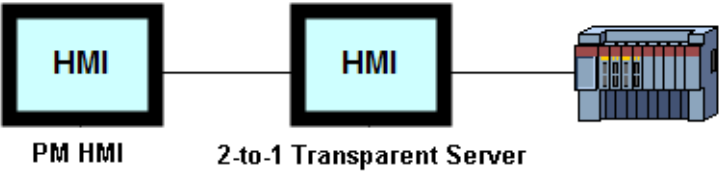
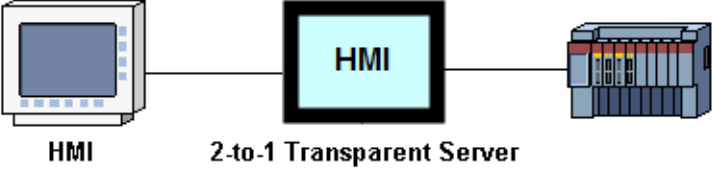
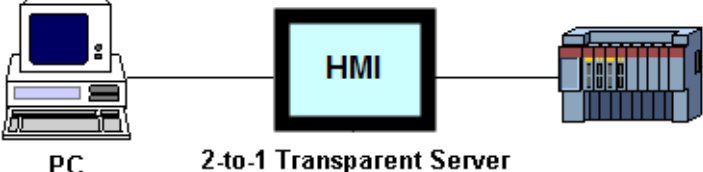
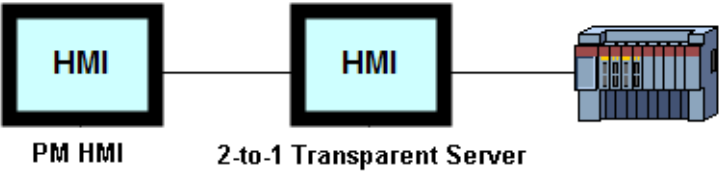
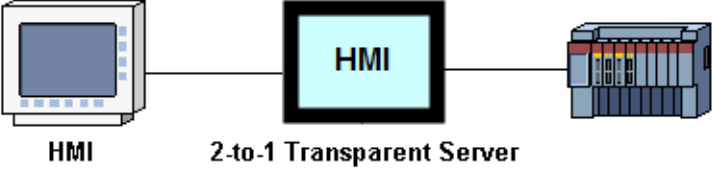
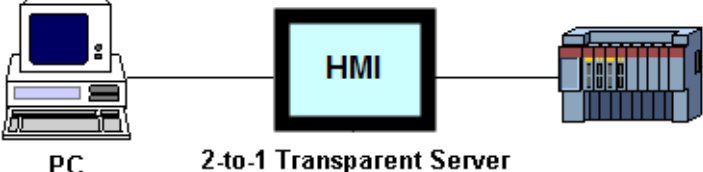
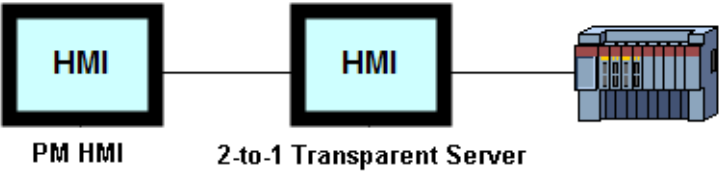
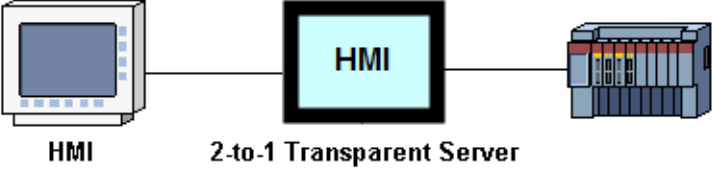
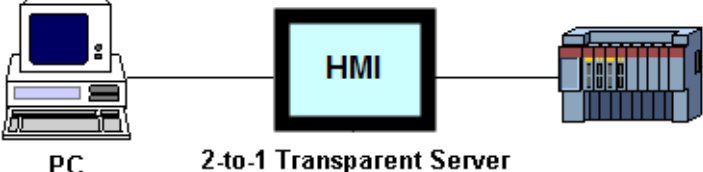

Link Type	Description										
Communication service	<p>To allow other panels to communicate with the device that is directly connected to the target panel, you need to add an appropriate communication service link to the application for that purpose. The following table describes the available communication services.</p>										
	<table border="1"> <thead> <tr> <th data-bbox="339 369 678 434">Communication Service</th> <th data-bbox="678 369 1481 434">Description</th> </tr> </thead> <tbody> <tr> <td data-bbox="339 434 678 568">2-to-1 Server (COM)</td> <td data-bbox="678 434 1481 568">You need to specify the data link, i.e. the associated direct link, for this communication service. This service allows two panels to talk with one device and only one communication port is required on that device.</td> </tr> <tr> <td data-bbox="339 568 678 1576">2-to-1 Transparent Server (COM)</td> <td data-bbox="678 568 1481 1576"> <p>This communication service makes the target panel a gateway for another computing device, such as a PC, another MT panel, or a panel of other brand, to access the associated controller. See the following diagrams to know the possible applications.</p> <div style="text-align: center;">  <p>PM HMI                      2-to-1 Transparent Server</p>  <p>HMI                                      2-to-1 Transparent Server</p>  <p>PC    2-to-1 Transparent Server</p> </div> <p>Any kinds of controller whose communication protocol is of the request-reply type can be supported by this communication service. Ask your local representative to check if your controller is supported. Note that the communication parameters (baud rate, number of data bits, number of stop bits, and type of parity check) of the computing device and the communication parameters of the 2-to-1 Transparent Server must be identical.</p> </td> </tr> <tr> <td data-bbox="339 1576 678 1711">N-to-1 Master (COM)</td> <td data-bbox="678 1576 1481 1711">You need to specify the data link, i.e. the associated direct link, for this communication service. This service allows up to 16 panels to talk with one device and only one communication port is required on that device.</td> </tr> <tr> <td data-bbox="339 1711 678 1845">N-to-1 Master (Ethernet)</td> <td data-bbox="678 1711 1481 1845">You need to specify the data link, i.e. the associated direct link, for this communication service. This service allows up to 16 panels to talk with one device and only one communication port is required on that device.</td> </tr> </tbody> </table>	Communication Service	Description	2-to-1 Server (COM)	You need to specify the data link, i.e. the associated direct link, for this communication service. This service allows two panels to talk with one device and only one communication port is required on that device.	2-to-1 Transparent Server (COM)	<p>This communication service makes the target panel a gateway for another computing device, such as a PC, another MT panel, or a panel of other brand, to access the associated controller. See the following diagrams to know the possible applications.</p> <div style="text-align: center;">  <p>PM HMI                      2-to-1 Transparent Server</p>  <p>HMI                                      2-to-1 Transparent Server</p>  <p>PC    2-to-1 Transparent Server</p> </div> <p>Any kinds of controller whose communication protocol is of the request-reply type can be supported by this communication service. Ask your local representative to check if your controller is supported. Note that the communication parameters (baud rate, number of data bits, number of stop bits, and type of parity check) of the computing device and the communication parameters of the 2-to-1 Transparent Server must be identical.</p>	N-to-1 Master (COM)	You need to specify the data link, i.e. the associated direct link, for this communication service. This service allows up to 16 panels to talk with one device and only one communication port is required on that device.	N-to-1 Master (Ethernet)	You need to specify the data link, i.e. the associated direct link, for this communication service. This service allows up to 16 panels to talk with one device and only one communication port is required on that device.
	Communication Service	Description									
	2-to-1 Server (COM)	You need to specify the data link, i.e. the associated direct link, for this communication service. This service allows two panels to talk with one device and only one communication port is required on that device.									
	2-to-1 Transparent Server (COM)	<p>This communication service makes the target panel a gateway for another computing device, such as a PC, another MT panel, or a panel of other brand, to access the associated controller. See the following diagrams to know the possible applications.</p> <div style="text-align: center;">  <p>PM HMI                      2-to-1 Transparent Server</p>  <p>HMI                                      2-to-1 Transparent Server</p>  <p>PC    2-to-1 Transparent Server</p> </div> <p>Any kinds of controller whose communication protocol is of the request-reply type can be supported by this communication service. Ask your local representative to check if your controller is supported. Note that the communication parameters (baud rate, number of data bits, number of stop bits, and type of parity check) of the computing device and the communication parameters of the 2-to-1 Transparent Server must be identical.</p>									
N-to-1 Master (COM)	You need to specify the data link, i.e. the associated direct link, for this communication service. This service allows up to 16 panels to talk with one device and only one communication port is required on that device.										
N-to-1 Master (Ethernet)	You need to specify the data link, i.e. the associated direct link, for this communication service. This service allows up to 16 panels to talk with one device and only one communication port is required on that device.										



### 3.4.2. General Settings

This section describes how to define the general settings for the communication links using the General page of the Link Properties dialog box. The following is an example of the General page that defines a direct link.

The screenshot shows the 'Link Properties' dialog box with the 'General' tab selected. The settings are as follows:

- Link Number: 1
- Link Name: LINK1
- Link Type: Direct Link (COM)
- Device/Server: ASI Controls (dropdown), ASIC/2 Protocol (None Token) (dropdown)
- Link Port: COM1 ( LINK1 ) (dropdown),  Sub-links
- Record communication status in operation log
- Check Word
- The duration of showing a communication error message: 5 second(s)

Buttons: OK, Cancel, Help

The following is an example of the General page that defines a communication service link.

The screenshot shows the 'Link Properties' dialog box with the 'General' tab selected. The settings are as follows:

- Link Number: 2
- Link Name: Server
- Link Type: Communication Service (COM)
- Device/Server: PanelMaster (dropdown), 2-to-1 Server (COM) (dropdown)
- Link Port: COM2 ( Server ) (dropdown)
- Data Link: LINK1 (dropdown)
- The duration of showing a communication error message: 5 second(s)

Buttons: OK, Cancel, Help



The following table describes each property in the General page of the Link Properties dialog box.

Property	Description																
Link Number	The sequence number of the communication link. It is assigned when the link is created and it will be reassigned when any other link of the same application is removed.																
Link Name	Specifies the name of the communication link.																
Link Type	Select one of the following link types for the link: <table border="1" data-bbox="395 427 1485 1350"> <thead> <tr> <th>Link Type</th> <th>Description</th> </tr> </thead> <tbody> <tr> <td>Direct Link (COM)</td> <td>The link connects to the specified device directly through the specified serial (COM) port.</td> </tr> <tr> <td>Direct Link (Ethernet)</td> <td>The link connects to the specified device directly through the specified Ethernet port.</td> </tr> <tr> <td>Communication Service (COM)</td> <td>The link connects to one or more other MT panels through the specified serial (COM) port and provides the communication service specified in the Device/Server field to the connected MT panels. See the description of the Device/Server field to know the available communication services.</td> </tr> <tr> <td>Communication Service (Ethernet)</td> <td>The link connects to one or more other MT panels through the specified Ethernet port and provides the communication service specified in the Device/Server field to the connected MT panels. See the description of the Device/Server field to know the available communication services.</td> </tr> <tr> <td>Indirect Link via 2-to-1 Connection (COM)</td> <td>The link connects to a MT panel that provides the communication service as a 2-to1 server through the specified serial (COM) port. The target panel can communicate with the associated device indirectly through that MT panel.</td> </tr> <tr> <td>Indirect Link via N-to-1 Connection (COM)</td> <td>The link connects to a MT panel that provides the communication service as a N-to1 master through the specified serial (COM) port. The target panel can communicate with the associated device indirectly through that MT panel.</td> </tr> <tr> <td>Indirect Link via N-to-1 Connection (Ethernet)</td> <td>The link connects to a MT panel that provides the communication service as a N-to1 master through the specified Ethernet port. The target panel can communicate with the associated device indirectly through that MT panel.</td> </tr> </tbody> </table>	Link Type	Description	Direct Link (COM)	The link connects to the specified device directly through the specified serial (COM) port.	Direct Link (Ethernet)	The link connects to the specified device directly through the specified Ethernet port.	Communication Service (COM)	The link connects to one or more other MT panels through the specified serial (COM) port and provides the communication service specified in the Device/Server field to the connected MT panels. See the description of the Device/Server field to know the available communication services.	Communication Service (Ethernet)	The link connects to one or more other MT panels through the specified Ethernet port and provides the communication service specified in the Device/Server field to the connected MT panels. See the description of the Device/Server field to know the available communication services.	Indirect Link via 2-to-1 Connection (COM)	The link connects to a MT panel that provides the communication service as a 2-to1 server through the specified serial (COM) port. The target panel can communicate with the associated device indirectly through that MT panel.	Indirect Link via N-to-1 Connection (COM)	The link connects to a MT panel that provides the communication service as a N-to1 master through the specified serial (COM) port. The target panel can communicate with the associated device indirectly through that MT panel.	Indirect Link via N-to-1 Connection (Ethernet)	The link connects to a MT panel that provides the communication service as a N-to1 master through the specified Ethernet port. The target panel can communicate with the associated device indirectly through that MT panel.
Link Type	Description																
Direct Link (COM)	The link connects to the specified device directly through the specified serial (COM) port.																
Direct Link (Ethernet)	The link connects to the specified device directly through the specified Ethernet port.																
Communication Service (COM)	The link connects to one or more other MT panels through the specified serial (COM) port and provides the communication service specified in the Device/Server field to the connected MT panels. See the description of the Device/Server field to know the available communication services.																
Communication Service (Ethernet)	The link connects to one or more other MT panels through the specified Ethernet port and provides the communication service specified in the Device/Server field to the connected MT panels. See the description of the Device/Server field to know the available communication services.																
Indirect Link via 2-to-1 Connection (COM)	The link connects to a MT panel that provides the communication service as a 2-to1 server through the specified serial (COM) port. The target panel can communicate with the associated device indirectly through that MT panel.																
Indirect Link via N-to-1 Connection (COM)	The link connects to a MT panel that provides the communication service as a N-to1 master through the specified serial (COM) port. The target panel can communicate with the associated device indirectly through that MT panel.																
Indirect Link via N-to-1 Connection (Ethernet)	The link connects to a MT panel that provides the communication service as a N-to1 master through the specified Ethernet port. The target panel can communicate with the associated device indirectly through that MT panel.																

Continued



Property		Description								
Device/Server		When the Link Type is Direct Link, select a device to specify the connected device of this link.								
		When the Link Type is Communication Service (COM), select one of the following servers.								
		<table border="1"> <thead> <tr> <th>Server</th> <th>Description</th> </tr> </thead> <tbody> <tr> <td>2-to-1 Server</td> <td>You need to specify a direct link of the application as the data link for the service in the Data Link field. The link connects to a MT panel and allows that panel to communicate with the device connected by the specified data link indirectly. The panel served by the link must use an indirect link to accept the service.</td> </tr> <tr> <td>2-to-1 Transparent Server</td> <td>You need to specify a direct link of the application as the data link for the service in the Data Link field. The link connects to a computing device and allows that device to communicate with the device connected by the specified data link indirectly. The computing device can be a MT panel, a panel of other brand, or a PC. If the computing device is a MT panel, it must use a direct link to accept the service.</td> </tr> <tr> <td>N-to-1 Master</td> <td>You need to specify a direct link of the application as the data link for the service. The link can connect up to 8 MT panels and allow those panels to communicate with the device connected by the specified data link indirectly. The panels served by the link must use an indirect link to accept the service.</td> </tr> </tbody> </table>	Server	Description	2-to-1 Server	You need to specify a direct link of the application as the data link for the service in the Data Link field. The link connects to a MT panel and allows that panel to communicate with the device connected by the specified data link indirectly. The panel served by the link must use an indirect link to accept the service.	2-to-1 Transparent Server	You need to specify a direct link of the application as the data link for the service in the Data Link field. The link connects to a computing device and allows that device to communicate with the device connected by the specified data link indirectly. The computing device can be a MT panel, a panel of other brand, or a PC. If the computing device is a MT panel, it must use a direct link to accept the service.	N-to-1 Master	You need to specify a direct link of the application as the data link for the service. The link can connect up to 8 MT panels and allow those panels to communicate with the device connected by the specified data link indirectly. The panels served by the link must use an indirect link to accept the service.
		Server	Description							
		2-to-1 Server	You need to specify a direct link of the application as the data link for the service in the Data Link field. The link connects to a MT panel and allows that panel to communicate with the device connected by the specified data link indirectly. The panel served by the link must use an indirect link to accept the service.							
2-to-1 Transparent Server	You need to specify a direct link of the application as the data link for the service in the Data Link field. The link connects to a computing device and allows that device to communicate with the device connected by the specified data link indirectly. The computing device can be a MT panel, a panel of other brand, or a PC. If the computing device is a MT panel, it must use a direct link to accept the service.									
N-to-1 Master	You need to specify a direct link of the application as the data link for the service. The link can connect up to 8 MT panels and allow those panels to communicate with the device connected by the specified data link indirectly. The panels served by the link must use an indirect link to accept the service.									
When the Link Type is Communication Service (Ethernet), select one of the following servers .										
<table border="1"> <thead> <tr> <th>Service</th> <th>Description</th> </tr> </thead> <tbody> <tr> <td>N-to-1 Master</td> <td>You need to specify a direct link of the application as the data link for the service in the Data Link field. The link can connect up to 8 MT panels and allow those panels to communicate with the device connected by the specified data link indirectly. The panels served by the link must use an indirect link to accept the service.</td> </tr> </tbody> </table>	Service	Description	N-to-1 Master	You need to specify a direct link of the application as the data link for the service in the Data Link field. The link can connect up to 8 MT panels and allow those panels to communicate with the device connected by the specified data link indirectly. The panels served by the link must use an indirect link to accept the service.						
Service	Description									
N-to-1 Master	You need to specify a direct link of the application as the data link for the service in the Data Link field. The link can connect up to 8 MT panels and allow those panels to communicate with the device connected by the specified data link indirectly. The panels served by the link must use an indirect link to accept the service.									
When the Link Type is Indirect Link and the Indirect Link Server Location is specified, the indirectly connected device is shown here.										
Link Port		Select a port for this link.								
Sub-links		When an RS485 communication line has many devices connected to it, the logical connection of a device on the link with the MT panel is called a sub-link. This field is available when the Link Type is Direct Link (COM). Select this option if this link will connect to many devices and you want to identify, monitor, or control the communication with each connected device.								
Data Link		Select a direct link of the application as the data link for the communication service when the Link Type is Communication Service.								
Indirect Link Server Location	Panel Application	Select the panel application that provides the communication service for this indirect link.								
	Link	Select the communication service link provides the communication service for this indirect link.								
Record communication status in operation log		Check this option if you want the communication status of the link or the link's sub-links to be recorded in the operation log. The recordable types of status include: Enabled, Disabled, Failed, and Recovered.								
Check Word		The panel will read the specified word once in a while to check if the connection of the link is good.								
The duration of showing a communication error message		The communication error message box will hide and show according to the specified duration. If the duration is 0, the error message box will not show.								

### 3.4.3. Parameter Settings (Serial Port)

This section describes how to set up the communication parameters for the serial communication links using the Parameter page of the Link Properties dialog box.

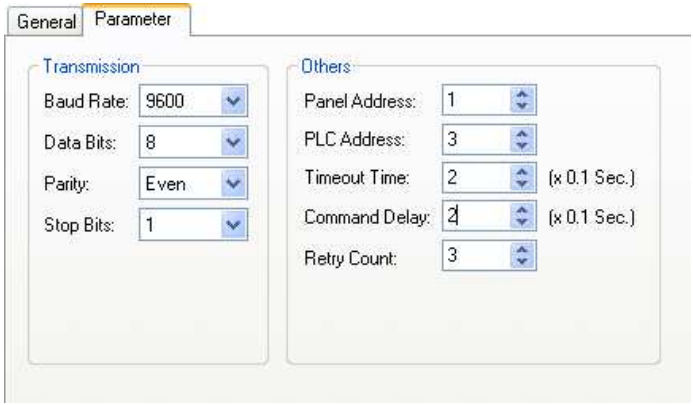
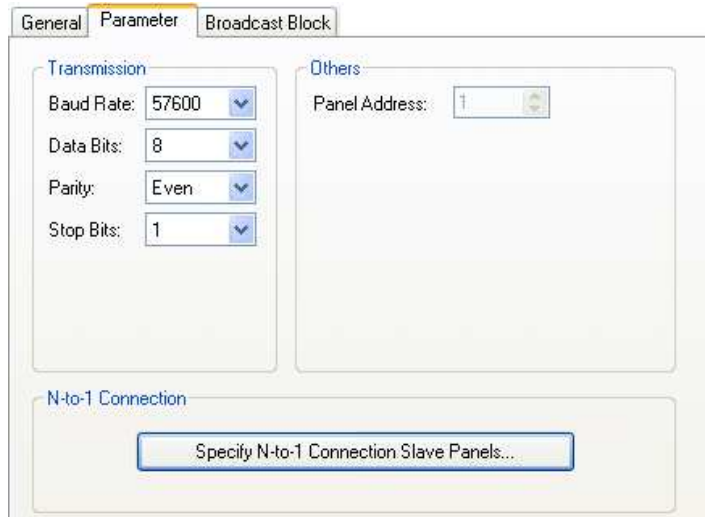
<p>The following is an example of the Parameter page for a serial direct link.</p>	<p>The following is an example of the Parameter page for a N-to-1 master.</p>
	

The following table describes each property in the Parameter page of the Link Properties dialog box for a serial link.

Property	Description
Baud Rate	The baud rate used.
Data Bits	The number of data bits used.
Parity	The scheme of parity used.
Stop Bits	The number of stop bits used.
Panel Address	The address of the target panel.
PLC Address	The address of the connected device.
Timeout Time	The maximum time allowed for the communication driver to wait for the reply from the connected device. When the elapsed time exceeds the Timeout Time, the communication driver assumes the communication failed.
Command Delay	If the Command Delay is 0, the communication driver sends the next request immediately to the connected device after it received the reply of the last request. If the Command Delay is nonzero, the communication driver delays the specified time before sending the next request to the connected device.
Retry Count	The number of times that the communication driver will retry to get a successful reply from the connected device for each request. If the number is zero, the communication driver will use a default retry count.
Specify N-to-1 Connection Slave Panels	This button is available when the link is a N-to-1 master. Click this button to bring up the N-to-1 Connection Slave Panels dialog box. You can define the slave panels of the N-to-1 connection in the dialog box.
Specify Other Data Sharing Panels	This button is available when the link is a direct link and the connected device is Data Sharer (RS485). Click this button to bring up the Other Data Sharing Panels dialog box. You can define the other data sharing panels in the dialog box.



### 3.4.4. Parameter Settings (Ethernet Port)

This section describes how to set up the communication parameters for the Ethernet links using the Parameter page of the Link Properties dialog box. The following is an example of the Parameter page for an Ethernet direct link.

The screenshot shows the 'Parameter' tab of a dialog box. It contains the following settings:

- IP Address: 192.168.10.33
- Use Default Port
- Port: 502
- Node Address: 1
- Timeout Time: 1 (x 0.1 Sec.)
- Command Delay: 1 (x 0.1 Sec.)
- Retry Count: 3

The following table describes each property in the Parameter page of the Link Properties dialog box for an Ethernet link.

Property	Description
IP Address	The IP address of the connected device.
Use Default Port	Check this option if the default IP port is used
Port	Specifies the IP port used
Node Address	Specifies the node address of the connected device.
Timeout Time	The maximum time allowed for the communication driver to wait for the reply from the connected device. When the elapsed time exceeds the Timeout Time, the communication driver assumes the communication failed.
Command Delay	If the Command Delay is 0, the communication driver sends the next request immediately to the connected device after it received the reply of the last request. If the Command Delay is nonzero, the communication driver delays the specified time before sending the next request to the connected device.
Retry Count	The number of times that the communication driver will retry to get a successful reply from the connected device for each request. If the number is zero, the communication driver will use a default retry count.

### 3.4.5. Sub-link Settings

This section describes how to define the sub-links for the direct links using the Sub-link page of the Link Properties dialog box. The following is an example of the Sub-link page.

Number of sub-links: 6

	Name	Node	State	Show
1	TC1	10	On	Yes
2	TC2	20	On	Yes
3	TC3	30	On	Yes
4	TC4	40	On	Yes
5	TC5	50	Off	Yes
6	TC6	60	Off	Yes

Language: English

Sub-link Name: TC6

Node Address: 60

Initial State: Off

Show error message

Alt+Up: Move item up      Alt+Down: Move item down

The following table describes each property in the Sub-link page of the Link Properties dialog box for a direct link.

Property	Description
Number of sub-links	Specifies how many devices the link will connects as sub-links.
Language	Specifies the current language for the Name field.
Name	The name of the selected sub-link for the language specified in the Language field.
Node Address	The address of the selected sub-link. The address must be a unique number within all the sub-links.
Initial State	The initial communication state for the selected sub-link. If the state is On, the panel will communicate with the sub-link after running the application. If the state is Off, the panel will not communicate with the sub-link until the communication state is turn On in a sub-link table.
Show error message	If this option is checked, the communication error message will be shown when the selected sub-link encounters communication errors. If this option is unchecked, no error message will be shown for any communication errors.



### 3.4.6. Sharing Data among Panels Using Data Sharer

The data sharer is a virtual device. It allows data sharing among up to 16 MT panels on an Ethernet or an RS485 network. Each of the MT panels can have up to 256 words of data to share.

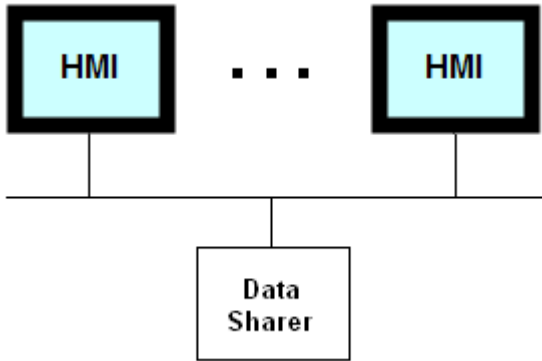

To set up the communication for the data sharing, create a direct link and select Data Sharer (UDP) or Data Sharer (RS485) of PanelMaster as the connected device. The panel address that you can set in the Parameter page of the Link Properties dialog box must be unique for each sharing panels as it is used to identify the shared data.

The communication driver for the link connecting to Data Sharer is responsible for broadcasting the panel's shared data on the network. For example, if the panel address of a panel is 10 and the number of the link connecting to Data Sharer is 2, the following Macro command will cause the communication driver to broadcast the corresponding data on the network.

```
2\P10.0 = MOV($u300, 30)
```

The communication driver receives the broadcasted shared data on the network automatically. It has a block of memory to store the shared data. To access a word, use the following address, where  $m$  is the panel address and  $n$  is the word number of that panel's shared data.

$Pm.n$        $m=1\sim 16; n=0-255$

To access a bit, use the following address, where  $b$  is a hexadecimal number representing the bit number in the specified word.

$Pm.n.b$        $m=1\sim 16; n=0-255; b=0\sim f$

The UDP is used for the data sharing on Ethernet.





### 3.5. Sound Table

The sound table contains all the sounds used by the panel application. The sound table is empty initially after the panel application is created.

You can use the sound only if the target panel is PM SCADA. In the PM SCADA application, you can use function button with play sound operation to play the specified sound.

Before using the sound in the panel application, you need to import or add a sound into the Sound Table.

To open the Sound Table dialog box, please do one of the followings:

- 1) In the PM Designer's Project Manager tool window, double-click the Sound Table (  ) node in Panel Application.
- 2) In the PM Designer's Project Manager tool window, right-click the Sound Table (  ) node to bring out the popup menu and select Properties menu item.
- 2) On the Panel menu, click Sound Table...

The following is an example of the Sound Table dialog box.

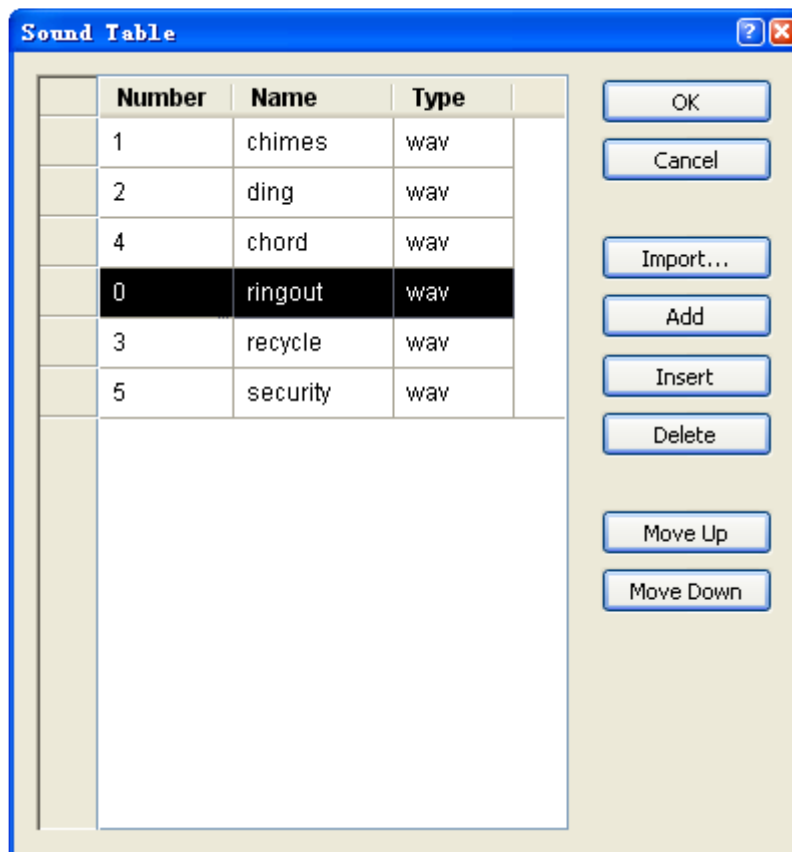



The following table describes how to read or use each of the items in the dialog box.

Item	Description								
Sounds	<p>Lists the sounds for the panel application. You can select a sound as the current selection. You can also make multiple selections. To select a sound, click the row on its header column of that sound in the list. To select multiple rows, click the row on its header column and use Ctrl + Click to add a row to the selection.</p> <p>The following table describes each column in the sound list.</p> <table border="1"> <thead> <tr> <th>Column</th> <th>Description</th> </tr> </thead> <tbody> <tr> <td>Number</td> <td>The number of the sound in the sound list. The number is an unsigned integer starting from 0. It must be unique in the panel application. You can click the cell and then edit the number.</td> </tr> <tr> <td>Name</td> <td>The name of the sound. You can click the cell to select a sound predefined in the Sound Database from the drop down list. To know how to predefine sounds in Sound Database, please see <a href="#">Section 2.1.3</a>.</td> </tr> <tr> <td>Type</td> <td>Displays the type of the sound.</td> </tr> </tbody> </table>	Column	Description	Number	The number of the sound in the sound list. The number is an unsigned integer starting from 0. It must be unique in the panel application. You can click the cell and then edit the number.	Name	The name of the sound. You can click the cell to select a sound predefined in the Sound Database from the drop down list. To know how to predefine sounds in Sound Database, please see <a href="#">Section 2.1.3</a> .	Type	Displays the type of the sound.
Column	Description								
Number	The number of the sound in the sound list. The number is an unsigned integer starting from 0. It must be unique in the panel application. You can click the cell and then edit the number.								
Name	The name of the sound. You can click the cell to select a sound predefined in the Sound Database from the drop down list. To know how to predefine sounds in Sound Database, please see <a href="#">Section 2.1.3</a> .								
Type	Displays the type of the sound.								
OK	Closes the dialog box and accepts all changes to the sound table.								
Cancel	Closes the dialog box and discards all changes to the sound table.								
Import...	Imports a sound from a sound file. The types of importable sound files include: WAV only.								
Add	Adds a sound from the Sound Database to the end of the sound table. To know how to use Sound Database, please see <a href="#">Section 2.1.3</a> .								
Insert	Inserts a sound from the Sound Database before the selection. To know how to use Sound Database, please see <a href="#">Section 2.1.3</a> . This button is available when the selection is made.								
Delete	Deletes all the selections. This button is available when the selection is made.								
Move Up	Moves the selection one item down in the list. This button is available when the selection is made.								
Move Down	Moves the selection one item up in the list. This button is available when the selection is made.								



## 3.6. Command Block and Status Words

You can command the panel to do a variety of things using the command block. The command block is a block of words in your controller or the internal memory. The panel scans the control block periodically and performs the specified operations according to the contents of the control block. You can decide the size of the command block, the command words that are required in the command block, and the rate of scanning the command block, so the overhead of reading the command block is minimized.

The panel can provide its status information to you by writing status values to the status words. The status words are in your controller or the internal memory. You can decide the status words that are required for your application so the panel will not waste time to output useless status values.

### 3.6.1. Types of Command Block and Status Words

There are three types of control block and status words that you can choose for your application.

#### 3.6.1.1. Type A

##### ■ Type A Command Block

You can have the following command words for the application and their orders in the command block are adjustable.

##### Screen Switching Register

You can command the panel to change the main screen or display a window screen by setting this word to the number of the desired screen.

##### Command Flag Word (Command Flags #0 ~ #15)

The following table describes the function of each bit in the Command Flag Word.

Bit	Function	Description
0	(reserved)	
1	Switch Language	Changes the language that the panel displays. Parameter One Register: Specifies the number of the desired language
2	Set Current Recipe Number	Sets the current recipe number of the specified recipe block to the specified recipe number. Parameter One Register: Specifies the recipe number Parameter Two Register: Specifies the recipe block <b>Note:</b> You do not need to specify the recipe block if the application has only one recipe block.
3	Read Recipe From PLC	Reads a recipe from the specified address which is defined in the Recipe Block dialog box and use that recipe to replace the specified recipe of the specified recipe block. Parameter One Register: Specifies the recipe number Parameter Two Register: Specifies the recipe block <b>Note:</b> You do not need to specify the recipe block if the application has only one recipe block.
4	Write Recipe To PLC	Writes the specified recipe of the specified recipe block to the specified address which is defined in the Recipe Block dialog box. Parameter One Register: Specifies the recipe number Parameter Two Register: Specifies the recipe block <b>Note:</b> You do not need to specify the recipe block if the application has only one recipe block.
5	Clear Alarm History	Clears the alarm history.

Continued



Bit	Function	Description												
6	Clear Alarm Count	Clears the alarm counts.												
7	Sound Buzzer	Sounds buzzer. Parameter One Register: Specifies the sound type. <table border="1" data-bbox="528 365 1482 622"> <thead> <tr> <th>Sound Type Value</th> <th>Description</th> </tr> </thead> <tbody> <tr> <td>0</td> <td>Continuous beep</td> </tr> <tr> <td>1</td> <td>500ms beeps</td> </tr> <tr> <td>2</td> <td>200ms beeps</td> </tr> <tr> <td>3</td> <td>100ms beeps</td> </tr> <tr> <td>4</td> <td>50ms beeps</td> </tr> </tbody> </table>	Sound Type Value	Description	0	Continuous beep	1	500ms beeps	2	200ms beeps	3	100ms beeps	4	50ms beeps
Sound Type Value	Description													
0	Continuous beep													
1	500ms beeps													
2	200ms beeps													
3	100ms beeps													
4	50ms beeps													
8	Print Screen	Prints the specified screen. <table border="1" data-bbox="528 712 1482 949"> <thead> <tr> <th>Parameter One Register</th> <th>Operation</th> </tr> </thead> <tbody> <tr> <td>(Undefined)</td> <td>Prints the top screen.</td> </tr> <tr> <td>0</td> <td>Prints the top screen.</td> </tr> <tr> <td>The number of the screen to be printed</td> <td>Prints the specified screen. <b>Note:</b> This operation is not supported by ML035/037/057/058</td> </tr> </tbody> </table>	Parameter One Register	Operation	(Undefined)	Prints the top screen.	0	Prints the top screen.	The number of the screen to be printed	Prints the specified screen. <b>Note:</b> This operation is not supported by ML035/037/057/058				
Parameter One Register	Operation													
(Undefined)	Prints the top screen.													
0	Prints the top screen.													
The number of the screen to be printed	Prints the specified screen. <b>Note:</b> This operation is not supported by ML035/037/057/058													
9	Backlight On	Turns the backlight on.												
10	Backlight Off	Turns the backlight off.												
11	Set Current User Level	Sets the current user level to the specified level. Parameter One Register: the user level												
12	Close All Window Screens	Closes all window screens.												
13	(reserved)													
14	(reserved)													
15	Execute General Command	See the <a href="#">section 3.6.7 Using General Commands</a> for details.												

**Note:** To activate any of the above functions, you need to change the corresponding command bit from Off to On. The panel does not reset the command bit, so you have to reset the command bit before commanding the panel to perform the same function again. You should keep the state of the command bit long enough so the panel can detect the change. The best way is to use the corresponding acknowledge bit in the Command Status Word. The panel turns on the acknowledge bit when it detect the change. It is safe to reset the command bit when you see the acknowledge bit turns on. The panels turns off the acknowledge bit when it sees the command bit turns off.

### Low Trigger Word (Trigger Bits #0 ~ #15), High Trigger Word (Trigger Bits #16 ~ #31)

You can use the trigger bits to initiate the following operations:

- 1) Asking the associated data loggers to collect data
- 2) Asking the associated data loggers to clear their logging buffers
- 3) Executing event macros
- 4) Increasing the clock by one hour
- 5) Decreasing the clock by one hour
- 6) Logging in
- 7) Logging out
- 8) Asking the associated line charts to read and draw a new set of data.
- 9) Asking the associated line charts to clear its content.



- 10) Asking the associated scatter charts to read and draw a new set of data.
- 11) Asking the associated scatter charts to clear its content.

#### Enabling Word (Enabling Bits #0 ~ #15)

You can use the enabling bits to enable the following operations:

- 1) The data collection of data loggers

#### Parameter One Register

This word specifies the parameter #1 for the specified operation.

#### Parameter Two Register

This word specifies the parameter #2 for the specified operation.

#### Parameter Three Register

This word specifies the parameter #3 for the specified operation.

#### Parameter Four Register

This word specifies the parameter #4 for the specified operation.

#### ■ Type A Status Words

You can have the following status words for the application.

Status Word	Description
Command Status Word (Command Flag Ack. Bits #0 ~ #15)	Stores the acknowledge bits of the command bits #0 ~ #15.
Low Trigger Ack. Word (Trigger Ack. Bits #0 ~ #15)	Stores the acknowledge bits of the trigger bits #0 ~ #15.
High Trigger Ack. Word (Trigger Ack. Bits #16 ~ #31)	Stores the acknowledge bits of the trigger bits #16 ~ #31.
Current Screen Number Word	Stores the current main screen number.
Current Recipe Block ID Word	Stores the current recipe block number.
Current Recipe Number Word	Stores the current recipe number of the current recipe block.
Current User Level Word	Stores the current user level.
Current Language Word	Stores the current language number.



### 3.6.1.2. Type H (Binary)

#### ■ Type H (Binary) Command Block

You can have the following command words for the application.

##### Screen Number Register

You can command the panel to change the main screen or display a window screen by setting this word to the number of the desired screen. You can also use this word to request the panel to 1) change the language, 2) turn on the backlight, and 3) turn off the backlight. The following table describes how to program this word.

Bit	Description
0~9	Specifies the screen to be displayed.
11~13	Specifies the language that the panel displays for. 000: The panel does nothing. 001: The panel changes the language to language 1. 010: The panel changes the language to language 2. ... 111: The panel changes the language to language 7.
14	If this bit is On, the panel turns off the back light of the display.
15	If this bit is On, the panel turns on the back light of the display.

##### Command Flag Register

The following table describes the function of each bit in the Command Flag Register.

Bit	Function
0	Clears the alarm history.
1	Clears the alarm counts.
2	(reserved)
3	(reserved)
4	Writes the current recipe of recipe block #0 to the address defined in the Recipe Block dialog box of recipe block #0.
5	Sets the current recipe number of recipe block #0 to the number specified in Recipe Number Register.
6	Reads the recipe from the address defined in the Recipe Block dialog box of recipe block #0 and use it to replace the current recipe of recipe block #0.
7	Turns on the buzzer.
8	Used as trigger bit #4.
9	Used as trigger bit #5.
10	Used as trigger bit #6.
11	Used as trigger bit #7.
12	Used as trigger bit #0.
13	Used as trigger bit #1.
14	Used as trigger bit #2.
15	Used as trigger bit #3.

**Note:** To activate any of the above functions, you need to change the corresponding command bit from Off to On. The panel does not reset the command bit, so you have to reset the command bit before commanding the panel to perform the same function again. You should keep the state of the command bit long enough so the panel can detect the change. The best way is to use the corresponding acknowledge bit in the Command Status Word. The panel turns on the acknowledge bit when it detect the change. It's safe that you reset the command bit when you see the acknowledge bit turns on. The panels turns off the acknowledge bit when it sees the command bit turns off.

##### Recipe Number Register



The number in this word will be used as the current recipe number of recipe block #0 when bit 5 of Command Flag Register changes from Off to On.

#### ■ Type H (Binary) Status Words

You can have the following status words for the application.

Status Word	Description
Screen Status Word	Whenever the panel switches the main screen, it sets this word to the number of the current main screen.
Command Flag Ack. Word	Contains the acknowledge bits for the command flags of Command Flag Register.
Current Recipe Number Word	Stores the current recipe number of recipe block #0.

#### 3.6.1.3. Type H (BCD)

The command words and status words you can have for the application are the same as the H (Binary) type. However, the values in the following words must be in BCD format: Screen Number Register, Recipe Number Register, Screen Status Word, and Current Recipe Number Word.

### 3.6.2. General Settings

This section describes how to define the general settings for the command words and the status words using the General page of the Command & Status dialog box. The following is an example of the General page.

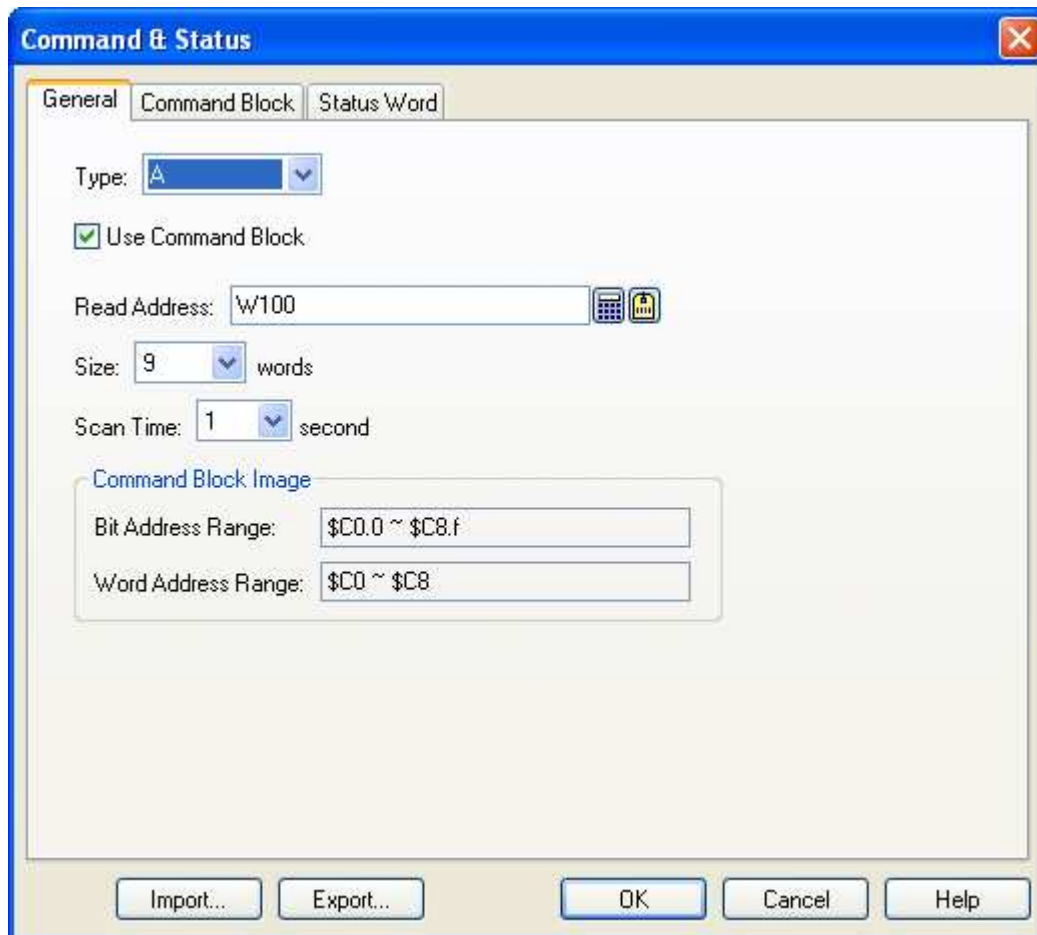

The following table describes each property in the General page.

Property		Description
Type		Select one of the following three types of control block and status words for your application: A, H (Binary), H (BCD)
Use Command Block		Check this item if the application needs any of the command words.
Read Address		Specifies the address of the command block.
Size		Specifies the size of the command block.
Scan Time		Select one of the following rate for the panel to scan the command block: 1 second, 0.5 second, 0.25 second
Command Block Image	Bit Address Range	Shows the valid address range of the bits in the command block. Note that the application can only read the bits.
	Word Address Range	Shows the valid address range of the words in the command block. Note that the application can only read the words.



### 3.6.3. Command Block Settings (Type A)

This section describes how to configure the type A command block using the Command Block page of the Command & Status dialog box. The following is an example of the Command Block page.

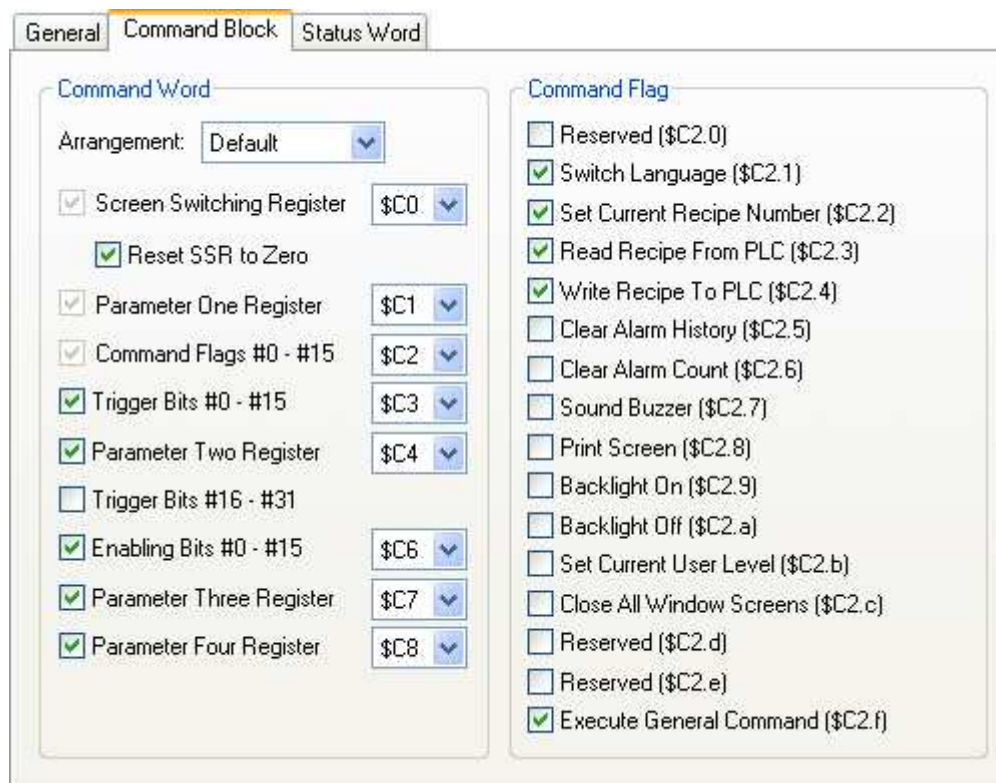

The following table describes each property in the Command Block page.

Property		Description
Command Word	Arrangement	Select <b>Default</b> if you want the command words to be in the default order in the command block. Select <b>Custom</b> if you want to arrange each command word in the command block by yourself.
	Screen Switching Register	Check this option so you can use the word to change the main screen or display a window screen by setting the word to the number of the desired screen.
	Reset SSR to Zero	If this option is selected, the panel always resets the Screen Switching Register to zero when it detects a nonzero value is in the word. If this option is not selected, the panel resets the Screen Switching Register to zero only when the specified screen is valid and not displayed yet.
	Parameter One Register	Check this option so you can this word to specify the No. 1 parameter for the specified operation.
	Command Flags #0 ~ #15 (Command Flag Word)	Check this option so you can use the command flags to request the panel to do the specified operations.
	Trigger Bits #0 ~ #15 (Low Trigger Word)	Check this option if you need any of the trigger bits in the word for your application.
	Parameter Two Register	Check this option so you can this word to specify the No. 2 parameter for the specified operation.
	Trigger Bits #16 ~ #31 (High Trigger Word)	Check this option if you need any of the trigger bits in the word for your application.

Continued



Property		Description											
Command Word	Enabling Bits #0 ~ #15 (Enabling Word)	Check this option if you need any of the enabling bits in the word for your application.											
	Parameter Three Register	Check this option so you can use this word to specify the No. 3 parameter for the specified operation.											
	Parameter Four Register	Check this option so you can use this word to specify the No. 4 parameter for the specified operation.											
Command Flag	Switch Language (#1)	Check this option so you can use command flag #1 to request the panel to display the specified language. You need to specify the following: 1) Parameter One Register: the number of the desired language											
	Set Current Recipe Number (#2)	Check this option so you can use command flag #2 to request the panel to set the current recipe number of the specified recipe block to the specified recipe number. You need to specify the following: 1) Parameter One Register: The recipe number 2) Parameter Two Register: The recipe block <b>(Note:</b> You do not need to specify the recipe block if the application has only one recipe block)											
	Read Recipe From PLC (#3)	Check this option so you can use command flag #3 to request the panel to read a recipe from the specified address which is defined in the Recipe Block dialog box and use that recipe to replace the specified recipe of the specified recipe block. You need to specify the following: 1) Parameter One Register: The recipe number 2) Parameter Two Register: The recipe block <b>(Note:</b> You do not need to specify the recipe block if the application has only one recipe block)											
	Write Recipe To PLC (#4)	Check this option so you can use command flag #4 to request the panel to write the specified recipe of the specified recipe block to the specified address which is defined in the Recipe Block dialog box. You need to specify the following: 1) Parameter One Register: The recipe number 2) Parameter Two Register: The recipe block <b>(Note:</b> You do not need to specify the recipe block if the application has only one recipe block)											
	Clear Alarm History (#5)	Check this option so you can use command flag #5 to request the panel to clear the alarm history.											
	Clear Alarm Count (#6)	Check this option so you can use command flag #6 to request the panel to clear the alarm counts.											
	Sound Buzzer (#7)	Check this option so you can use command flag #7 to request the panel to sound its buzzer in the specified manner. You need to specify the following: 1) Parameter One Register: The sound type. The following table describes the sound type value. <table border="1" data-bbox="614 1697 1433 1953"> <thead> <tr> <th>Sound Type Value</th> <th>Description</th> </tr> </thead> <tbody> <tr> <td>0</td> <td>Continuous beep</td> </tr> <tr> <td>1</td> <td>500ms beeps</td> </tr> <tr> <td>2</td> <td>200ms beeps</td> </tr> <tr> <td>3</td> <td>100ms beeps</td> </tr> <tr> <td>4</td> <td>50ms beeps</td> </tr> </tbody> </table>	Sound Type Value	Description	0	Continuous beep	1	500ms beeps	2	200ms beeps	3	100ms beeps	4
Sound Type Value	Description												
0	Continuous beep												
1	500ms beeps												
2	200ms beeps												
3	100ms beeps												
4	50ms beeps												

Continued



Property		Description
Command Flag	Print Screen (#8)	Check this option so you can use command flag #8 to request the panel to print the specified screen. You need to specify the following: 1) Parameter One Register: the number of the screen to be printed <b>Note1:</b> the top screen is printed if the number is zero or there is no Parameter One Register. <b>Note2:</b> the operation of printing a screen that is not the top screen is not supported by ML035/037/057/058
	Backlight On (#9)	Check this option so you can use command flag #9 to request the panel to turn its backlight on.
	Backlight Off (#10)	Check this option so you can use command flag #10 to request the panel to turn its backlight off.
	Set Current User Level (#11)	Check this option so you can use command flag #11 to request the panel to set the current user level to the specified one. You need to specify the following: 1) Parameter One Register: the user level
	Close All Window Screens (#12)	Check this option so you can use command flag #12 to request the panel to close all window screens.
	Execute General Command (#15)	Check this option so you can use command flag #15 to request the panel to perform the specified operation. See the <a href="#">section 3.6.7 Using General Commands</a> for details.



### 3.6.4. Status Word Settings (Type A)

This section describes how to configure the type A status words for your application using the Status Word page of the Command & Status dialog box. The following is an example of the Status Word page.

In the Status Word page, check the needed status words for your application and specify a word variable that will receive the status value for each checked status word.

The following table describes when and what the panel will write to each status word.

Status Word	Description
Command Flag Ack. Bits #0 ~ #15	The panel will write the states of all the effective command flags to this word whenever there is any state change occurring on the effective command flags.
Trigger Ack. Bits #0 ~ #15	The panel will write the states of trigger bits #0 ~ #15 to this word whenever there is any state change occurring on trigger bits #0 ~ #15.
Trigger Ack. Bits #16 ~ #31	The panel will write the states of trigger bits #16 ~ #31 to this word whenever there is any state change occurring on trigger bits #16 ~ #31.
Current Screen Number Word	The panel will write the number of the current main screen to this word whenever the main screen changes.
Current Recipe Block ID Word	The panel will write the current recipe block ID to this word whenever a different recipe block becomes the current recipe block.
Current Recipe Number Word	The panel will write the current recipe number of the current recipe block to this word whenever a different recipe becomes the current recipe of the current recipe block.
Current User Level Word	The panel will write the current user level to this word whenever the current user level changes.
Current Language Word	The panel will write the current language number to this word whenever it changes the language.

### 3.6.5. Command Block Settings (Type H)

This section describes how to configure the type H command block using the Command Block page of the Command & Status dialog box. The following is an example of the Command Block page.

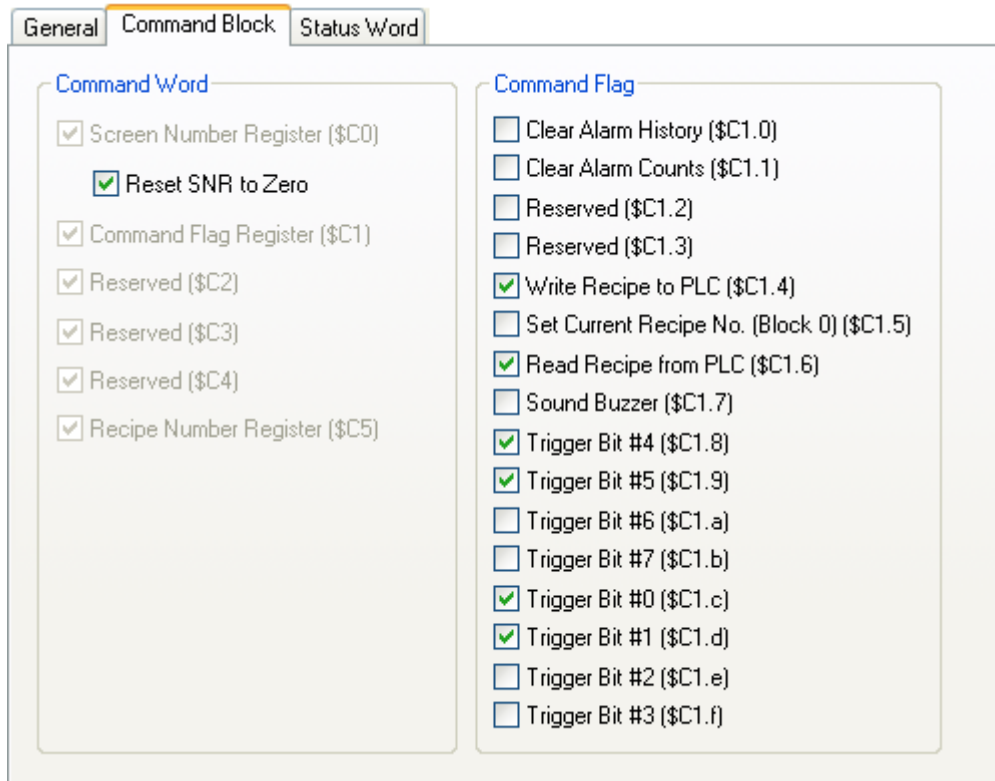

The following table describes each property in the Command Block page.

Property		Description										
Command Block	Screen Number Register	<p>You can use the word to change the main screen or display a window screen by setting the word to the number of the desired screen. You can also use this word to request the panel to do the following operations: 1) Change the language, 2) Turn on the backlight, and 3) Turn off the backlight.</p> <p>The following table describes how to program this word.</p> <table border="1"> <thead> <tr> <th>Bit</th> <th>Description</th> </tr> </thead> <tbody> <tr> <td>0~9</td> <td>Specifies the screen to be displayed.</td> </tr> <tr> <td>11~13</td> <td>Specifies the language that the panel displays for. 000: The panel does nothing. 001: The panel changes the language to language 1. 010: The panel changes the language to language 2. ... 111: The panel changes the language to language 7.</td> </tr> <tr> <td>14</td> <td>If this bit is On, the panel turns off the back light of the display.</td> </tr> <tr> <td>15</td> <td>If this bit is On, the panel turns on the back light of the display.</td> </tr> </tbody> </table>	Bit	Description	0~9	Specifies the screen to be displayed.	11~13	Specifies the language that the panel displays for. 000: The panel does nothing. 001: The panel changes the language to language 1. 010: The panel changes the language to language 2. ... 111: The panel changes the language to language 7.	14	If this bit is On, the panel turns off the back light of the display.	15	If this bit is On, the panel turns on the back light of the display.
Bit	Description											
0~9	Specifies the screen to be displayed.											
11~13	Specifies the language that the panel displays for. 000: The panel does nothing. 001: The panel changes the language to language 1. 010: The panel changes the language to language 2. ... 111: The panel changes the language to language 7.											
14	If this bit is On, the panel turns off the back light of the display.											
15	If this bit is On, the panel turns on the back light of the display.											

Continued



Property		Description
	Reset SNR to Zero	If this option is selected, the panel always resets the Screen Number Register to zero when it detects a nonzero value is in the word . If this option is not selected, the panel resets the Screen Number Register to zero only when the specified screen is valid and not displayed yet.
	Command Flag Register	You can use the command flags to request the panel to do the specified operations.
	Recipe Number Register	When you use command flag #5 to set the current recipe number for recipe block #0, you need to specify the recipe number in this word.
Command Flag	Clear Alarm History (#0)	Check this option so you can use command flag #0 to request the panel to clear the alarm history.
	Clear Alarm Counts (#1)	Check this option so you can use command flag #1 to request the panel to clear the alarm counts.
	Write Recipe To PLC (#4)	Check this option so you can use command flag #4 to request the panel to write the current recipe of recipe block #0 to the specified address which is defined in the Recipe Block dialog box.
	Set Current Recipe Number (#5)	Check this option so you can use command flag #5 to request the panel to set the current recipe number for recipe block #0. You need to specify the following: 1) Recipe Number Register: the recipe number
	Read Recipe From PLC (#6)	Check this option so you can use command flag #6 to request the panel to read a recipe from the specified address which is defined in the Recipe Block dialog box and use that recipe to replace the current recipe of recipe block #0.
	Sound Buzzer (#7)	Check this option so you can use command flag #7 to request the panel to sound its buzzer.
	Trigger Bit #4 (#8)	Check this option so command flag #8 will be used as trigger bit #4.
	Trigger Bit #5 (#9)	Check this option so command flag #9 will be used as trigger bit #5.
	Trigger Bit #6 (#10)	Check this option so command flag #10 will be used as trigger bit #6.
	Trigger Bit #7 (#11)	Check this option so command flag #11 will be used as trigger bit #7.
	Trigger Bit #0 (#12)	Check this option so command flag #12 will be used as trigger bit #0.
	Trigger Bit #1 (#13)	Check this option so command flag #13 will be used as trigger bit #1.
	Trigger Bit #2 (#14)	Check this option so command flag #14 will be used as trigger bit #2.
Trigger Bit #3 (#15)	Check this option so command flag #15 will be used as trigger bit #3.	

### 3.6.6. Status Word Settings (Type H)

This section describes how to configure the type H status words for your application using the Status Word page of the Command & Status dialog box. The following is an example of the Status Word page.

The screenshot shows the 'Status Word' tab of a dialog box. It features three status word settings:

- Screen Status Word: R100
- Command Flag Ack. Word: R101
- Current Recipe Number Word

In the Status Word page, check the needed status words for your application and specify a word variable that will receive the status value for each checked status word.

The following table describes when and what the panel will write to each status word.

Status Word	Description
Screen Status Word	The panel will write the number of the current main screen to this word whenever the main screen changes.
Command Flag Ack. Word	The panel will write the states of all the effective command flags to this word whenever there is any state change occurring on the effective command flags.
Current Recipe Number Word	The panel will write the current recipe number of recipe block #0 to this word whenever a different recipe becomes the current recipe of recipe block #0.





### 3.6.7. Using General Commands

This section describes how to use the general commands provided by the type A command block. To issue a general command, specify necessary parameters in the parameter registers and then turn on command flag #15 in Command Flag Register.

You can request the panel to perform the following file operations using the general command and the default filename:

Operation	Parameter One Register (Operation code)	Parameter Two Register (Data ID)	Default Filename Format
Save logged data to TXT file	1	ID of the data logger (0~15)	DL<ID>_<Date>_<Time>.txt
Save logged alarms to TXT file	2	(Not required)	AL_<Date>_<Time>.txt
Save alarm counts to TXT file	3	(Not required)	AC_<Date>_<Time>.txt
Save recipe data to TXT file	4	ID of the recipe block (0~15)	RB<ID>.txt
Save recipe data to DAT file	5	ID of the recipe block (0~15)	RB<ID>.dat
Print screen to BMP file (256 colors)	6	Number of the screen	S<ID>_<Date>_<Time>.bmp
Print screen to BMP file (64K colors)	7	Number of the screen	S<ID>_<Date>_<Time>.bmp
Save logged operations to TXT file	9	(Not required)	OL_<Date>_<Time>.txt
Save logged data to LDF file	10	ID of the data logger (0~15)	DL<ID>_<Date>_<Time>.ldf
Take picture and save it to BMP file	12	ID of the USB camera (0~3)	CAM<ID>_<Date>_<Time>.bmp
Take picture and save it to JPG file	13	ID of the USB camera (0~3)	CAM<ID>_<Date>_<Time>.jpg

**Note for default filename format:**

<ID>: ID of the data logger, ID of the recipe block, ID of the USB camera, or number of the screen

<Date>: date when saving the data; format is YYMMDD

<Time>: time when saving the data; format is hhmmss





You can request the panel to perform the following file operations using the general command and the specified filename:

Operation	Parameter One Register (Operation code)	Parameter Two Register (Data ID)	Parameter Three Register (Specified filename)
Save logged data to TXT file	31	ID of the data logger (0~15)	Specifies the address in the internal memory \$U that stores the specified filename or full pathname. The name must be a valid Windows pathname with ASCII characters only. The character string must be null terminated and each character occupies one byte. The maximum length of the string is 127. All the folders stated in the full pathname must already exist or the file operation will fail. For example, if the number stored in this register is 400, it means the specified filename is stored in \$U400.
Save logged alarms to TXT file	32	(Not required)	Same as above
Save alarm counts to TXT file	33	(Not required)	Same as above
Save recipe data to TXT file	34	ID of the recipe block (0~15)	Same as above
Save recipe data to DAT file	35	ID of the recipe block (0~15)	Same as above
Save logged operations to TXT file	39	(Not required)	Same as above
Save logged data to LDF file	40	ID of the data logger (0~15)	Same as above
Take picture and save it to BMP file	42	ID of the USB camera (0~3)	Same as above
Take picture and save it to JPG file	43	ID of the USB camera (0~3)	Same as above

### 3.7. Setting up Clock Operations

This section describes how to define the clock operations for the panel application using the Clock dialog box. The following is an example of the Clock dialog box.

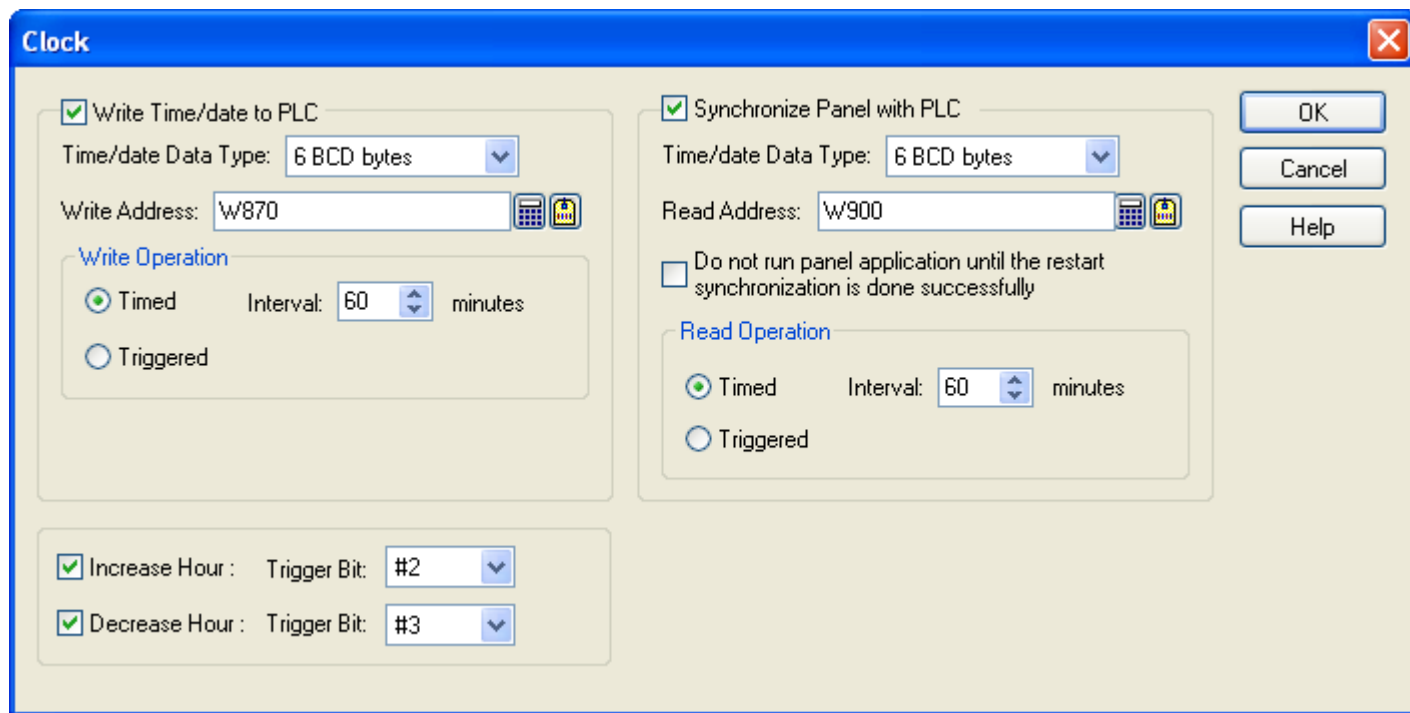

The following table describes each property in the Passwords dialog box.

Property		Description																	
Write	Write Time/date to PLC	Select this option so the panel will write time and date information to the specified variable.																	
	Time/date Data Type	Select one of the following data type for the output time and data information. <table border="1" style="width: 100%; border-collapse: collapse;"> <thead> <tr> <th>Data Type</th> <th>Description</th> </tr> </thead> <tbody> <tr> <td>6 BCD bytes</td> <td>                             The following shows the data structure.                             <table border="1" style="width: 100%; border-collapse: collapse;"> <thead> <tr> <th>Byte No.</th> <th>Content</th> </tr> </thead> <tbody> <tr> <td>0</td> <td>Minute; 0~59</td> </tr> <tr> <td>1</td> <td>Hour; 0~23</td> </tr> <tr> <td>2</td> <td>Day; 1~31</td> </tr> <tr> <td>3</td> <td>Month; 1~12</td> </tr> <tr> <td>4</td> <td>Year; 00~99</td> </tr> <tr> <td>5</td> <td>Day-of-week; 0(Sunday)~6(Saturday)</td> </tr> </tbody> </table> <p><b>Note:</b> All the values are in BCD format.</p> </td> </tr> </tbody> </table>	Data Type	Description	6 BCD bytes	The following shows the data structure. <table border="1" style="width: 100%; border-collapse: collapse;"> <thead> <tr> <th>Byte No.</th> <th>Content</th> </tr> </thead> <tbody> <tr> <td>0</td> <td>Minute; 0~59</td> </tr> <tr> <td>1</td> <td>Hour; 0~23</td> </tr> <tr> <td>2</td> <td>Day; 1~31</td> </tr> <tr> <td>3</td> <td>Month; 1~12</td> </tr> <tr> <td>4</td> <td>Year; 00~99</td> </tr> <tr> <td>5</td> <td>Day-of-week; 0(Sunday)~6(Saturday)</td> </tr> </tbody> </table> <p><b>Note:</b> All the values are in BCD format.</p>	Byte No.	Content	0	Minute; 0~59	1	Hour; 0~23	2	Day; 1~31	3	Month; 1~12	4	Year; 00~99	5
Data Type	Description																		
6 BCD bytes	The following shows the data structure. <table border="1" style="width: 100%; border-collapse: collapse;"> <thead> <tr> <th>Byte No.</th> <th>Content</th> </tr> </thead> <tbody> <tr> <td>0</td> <td>Minute; 0~59</td> </tr> <tr> <td>1</td> <td>Hour; 0~23</td> </tr> <tr> <td>2</td> <td>Day; 1~31</td> </tr> <tr> <td>3</td> <td>Month; 1~12</td> </tr> <tr> <td>4</td> <td>Year; 00~99</td> </tr> <tr> <td>5</td> <td>Day-of-week; 0(Sunday)~6(Saturday)</td> </tr> </tbody> </table> <p><b>Note:</b> All the values are in BCD format.</p>	Byte No.	Content	0	Minute; 0~59	1	Hour; 0~23	2	Day; 1~31	3	Month; 1~12	4	Year; 00~99	5	Day-of-week; 0(Sunday)~6(Saturday)				
Byte No.	Content																		
0	Minute; 0~59																		
1	Hour; 0~23																		
2	Day; 1~31																		
3	Month; 1~12																		
4	Year; 00~99																		
5	Day-of-week; 0(Sunday)~6(Saturday)																		

Continued



Property		Description																																																											
Write	Time/date Data Type	<table border="1"> <thead> <tr> <th>Data Type</th> <th>Description</th> </tr> </thead> <tbody> <tr> <td>8 BCD bytes</td> <td> <p>The following shows the data structure.</p> <table border="1"> <thead> <tr> <th>Byte No.</th> <th>Content</th> </tr> </thead> <tbody> <tr><td>0</td><td>Minute; 0~59</td></tr> <tr><td>1</td><td>Hour; 0~23</td></tr> <tr><td>2</td><td>Day; 1~31</td></tr> <tr><td>3</td><td>Month; 1~12</td></tr> <tr><td>4</td><td>Year; 00~99</td></tr> <tr><td>5</td><td>Day-of-week; 0(Sunday)~6(Saturday)</td></tr> <tr><td>6</td><td>Second; 0~59</td></tr> <tr><td>7</td><td>0</td></tr> </tbody> </table> <p><b>Note:</b> All the values are in BCD format.</p> </td> </tr> <tr> <td>7 BCD words</td> <td> <p>The following shows the data structure.</p> <table border="1"> <thead> <tr> <th>Word No.</th> <th>Content</th> </tr> </thead> <tbody> <tr><td>0</td><td>Second; 0~59</td></tr> <tr><td>1</td><td>Minute; 0~59</td></tr> <tr><td>2</td><td>Hour; 0~23</td></tr> <tr><td>3</td><td>Day; 1~31</td></tr> <tr><td>4</td><td>Month; 1~12</td></tr> <tr><td>5</td><td>Year; 00~99</td></tr> <tr><td>6</td><td>Day-of-week; 0(Sunday)~6(Saturday)</td></tr> </tbody> </table> <p><b>Note:</b> All the values are in BCD format.</p> </td> </tr> <tr> <td>7 binary words</td> <td> <p>The following shows the data structure.</p> <table border="1"> <thead> <tr> <th>Word No.</th> <th>Content</th> </tr> </thead> <tbody> <tr><td>0</td><td>Second; 0~59</td></tr> <tr><td>1</td><td>Minute; 0~59</td></tr> <tr><td>2</td><td>Hour; 0~23</td></tr> <tr><td>3</td><td>Day; 1~31</td></tr> <tr><td>4</td><td>Month; 1~12</td></tr> <tr><td>5</td><td>Year; 00~99</td></tr> <tr><td>6</td><td>Day-of-week; 0(Sunday)~6(Saturday)</td></tr> </tbody> </table> </td> </tr> </tbody> </table>	Data Type	Description	8 BCD bytes	<p>The following shows the data structure.</p> <table border="1"> <thead> <tr> <th>Byte No.</th> <th>Content</th> </tr> </thead> <tbody> <tr><td>0</td><td>Minute; 0~59</td></tr> <tr><td>1</td><td>Hour; 0~23</td></tr> <tr><td>2</td><td>Day; 1~31</td></tr> <tr><td>3</td><td>Month; 1~12</td></tr> <tr><td>4</td><td>Year; 00~99</td></tr> <tr><td>5</td><td>Day-of-week; 0(Sunday)~6(Saturday)</td></tr> <tr><td>6</td><td>Second; 0~59</td></tr> <tr><td>7</td><td>0</td></tr> </tbody> </table> <p><b>Note:</b> All the values are in BCD format.</p>	Byte No.	Content	0	Minute; 0~59	1	Hour; 0~23	2	Day; 1~31	3	Month; 1~12	4	Year; 00~99	5	Day-of-week; 0(Sunday)~6(Saturday)	6	Second; 0~59	7	0	7 BCD words	<p>The following shows the data structure.</p> <table border="1"> <thead> <tr> <th>Word No.</th> <th>Content</th> </tr> </thead> <tbody> <tr><td>0</td><td>Second; 0~59</td></tr> <tr><td>1</td><td>Minute; 0~59</td></tr> <tr><td>2</td><td>Hour; 0~23</td></tr> <tr><td>3</td><td>Day; 1~31</td></tr> <tr><td>4</td><td>Month; 1~12</td></tr> <tr><td>5</td><td>Year; 00~99</td></tr> <tr><td>6</td><td>Day-of-week; 0(Sunday)~6(Saturday)</td></tr> </tbody> </table> <p><b>Note:</b> All the values are in BCD format.</p>	Word No.	Content	0	Second; 0~59	1	Minute; 0~59	2	Hour; 0~23	3	Day; 1~31	4	Month; 1~12	5	Year; 00~99	6	Day-of-week; 0(Sunday)~6(Saturday)	7 binary words	<p>The following shows the data structure.</p> <table border="1"> <thead> <tr> <th>Word No.</th> <th>Content</th> </tr> </thead> <tbody> <tr><td>0</td><td>Second; 0~59</td></tr> <tr><td>1</td><td>Minute; 0~59</td></tr> <tr><td>2</td><td>Hour; 0~23</td></tr> <tr><td>3</td><td>Day; 1~31</td></tr> <tr><td>4</td><td>Month; 1~12</td></tr> <tr><td>5</td><td>Year; 00~99</td></tr> <tr><td>6</td><td>Day-of-week; 0(Sunday)~6(Saturday)</td></tr> </tbody> </table>	Word No.	Content	0	Second; 0~59	1	Minute; 0~59	2	Hour; 0~23	3	Day; 1~31	4	Month; 1~12	5	Year; 00~99	6	Day-of-week; 0(Sunday)~6(Saturday)	
		Data Type	Description																																																										
		8 BCD bytes	<p>The following shows the data structure.</p> <table border="1"> <thead> <tr> <th>Byte No.</th> <th>Content</th> </tr> </thead> <tbody> <tr><td>0</td><td>Minute; 0~59</td></tr> <tr><td>1</td><td>Hour; 0~23</td></tr> <tr><td>2</td><td>Day; 1~31</td></tr> <tr><td>3</td><td>Month; 1~12</td></tr> <tr><td>4</td><td>Year; 00~99</td></tr> <tr><td>5</td><td>Day-of-week; 0(Sunday)~6(Saturday)</td></tr> <tr><td>6</td><td>Second; 0~59</td></tr> <tr><td>7</td><td>0</td></tr> </tbody> </table> <p><b>Note:</b> All the values are in BCD format.</p>	Byte No.	Content	0	Minute; 0~59	1	Hour; 0~23	2	Day; 1~31	3	Month; 1~12	4	Year; 00~99	5	Day-of-week; 0(Sunday)~6(Saturday)	6	Second; 0~59	7	0																																								
		Byte No.	Content																																																										
0	Minute; 0~59																																																												
1	Hour; 0~23																																																												
2	Day; 1~31																																																												
3	Month; 1~12																																																												
4	Year; 00~99																																																												
5	Day-of-week; 0(Sunday)~6(Saturday)																																																												
6	Second; 0~59																																																												
7	0																																																												
7 BCD words	<p>The following shows the data structure.</p> <table border="1"> <thead> <tr> <th>Word No.</th> <th>Content</th> </tr> </thead> <tbody> <tr><td>0</td><td>Second; 0~59</td></tr> <tr><td>1</td><td>Minute; 0~59</td></tr> <tr><td>2</td><td>Hour; 0~23</td></tr> <tr><td>3</td><td>Day; 1~31</td></tr> <tr><td>4</td><td>Month; 1~12</td></tr> <tr><td>5</td><td>Year; 00~99</td></tr> <tr><td>6</td><td>Day-of-week; 0(Sunday)~6(Saturday)</td></tr> </tbody> </table> <p><b>Note:</b> All the values are in BCD format.</p>	Word No.	Content	0	Second; 0~59	1	Minute; 0~59	2	Hour; 0~23	3	Day; 1~31	4	Month; 1~12	5	Year; 00~99	6	Day-of-week; 0(Sunday)~6(Saturday)																																												
Word No.	Content																																																												
0	Second; 0~59																																																												
1	Minute; 0~59																																																												
2	Hour; 0~23																																																												
3	Day; 1~31																																																												
4	Month; 1~12																																																												
5	Year; 00~99																																																												
6	Day-of-week; 0(Sunday)~6(Saturday)																																																												
7 binary words	<p>The following shows the data structure.</p> <table border="1"> <thead> <tr> <th>Word No.</th> <th>Content</th> </tr> </thead> <tbody> <tr><td>0</td><td>Second; 0~59</td></tr> <tr><td>1</td><td>Minute; 0~59</td></tr> <tr><td>2</td><td>Hour; 0~23</td></tr> <tr><td>3</td><td>Day; 1~31</td></tr> <tr><td>4</td><td>Month; 1~12</td></tr> <tr><td>5</td><td>Year; 00~99</td></tr> <tr><td>6</td><td>Day-of-week; 0(Sunday)~6(Saturday)</td></tr> </tbody> </table>	Word No.	Content	0	Second; 0~59	1	Minute; 0~59	2	Hour; 0~23	3	Day; 1~31	4	Month; 1~12	5	Year; 00~99	6	Day-of-week; 0(Sunday)~6(Saturday)																																												
Word No.	Content																																																												
0	Second; 0~59																																																												
1	Minute; 0~59																																																												
2	Hour; 0~23																																																												
3	Day; 1~31																																																												
4	Month; 1~12																																																												
5	Year; 00~99																																																												
6	Day-of-week; 0(Sunday)~6(Saturday)																																																												
	Write Address	Specifies the variable that will receive the output time and date information.																																																											
	Write Operation	Timed	When this item is selected, the panel writes time and date information to the specified variable periodically at a rate specified in the Interval field. You can specify an interval between 1 and 255 minutes.																																																										
		Triggered	When this item is selected, the panel writes time and date information to the specified variable whenever the specified trigger bit changes from Off to On.																																																										

Continued



Property		Description
Read	Synchronize Panel with PLC	Select this option so the panel will read time and date information from the specified variable and adjust its clock accordingly.
	Time/date Data Type	Specifies the data type for the input time and data information. For details, see the description of the Time/date Data Type field of the Write group.
	Read Address	Specifies the variable that the panel will read the time and date information.
	Do not run panel application until the restart synchronization is done successfully	The password keypad will close automatically when it gets no input from the operator for the specified time.
	Read Operation	Timed
Triggered		When this item is selected, the panel reads time and date information from the specified variable whenever the specified trigger bit changes from Off to On.
Increase Hour		Select this option so you can increase the panel's clock by one by changing the specified trigger bit from Off to On.
Decrease Hour		Select this option so you can decrease the panel's clock by one by changing the specified trigger bit from Off to On.

### 3.8. Setting up Passwords

This section describes how to set up the passwords for the panel application using the Passwords dialog box. The following is an example of the Passwords dialog box.

User Level	Password	Comment
1	1111	Operator
2	2222	
3	3333	
4	4444	
5	5555	
6	6666	
7	7777	Maintenance
8	8888	Executive
<input checked="" type="checkbox"/> 9		Use developer password

Automatic login for operations requiring a higher user level  
 Login Trigger Bit: #7  
 Logout Trigger Bit: #8  
 Login Timeout: 30 seconds

The following table describes each property in the Passwords dialog box.

Property	Description
Password	The Password column contains 8 fields. You can specify the password for a user level in the corresponding field. A password is a positive integer up to 8 digits. A password must be unique within the application.
Comment	The Comment column contains 8 editable fields. You can type the comment for a password or user level in the corresponding field.
9	Check this item if you want the developer password to be the password with the highest privilege.
Automatic login for operations requiring a higher user level	The password keypad will display to get a password with a higher user level when the operator touches an object that requires a higher user level than the current one to perform the programmed operation.
Login Trigger Bit	When the specified trigger bit changes from Off to On, the password keypad will display to get a password. The operator can enter a valid password or cancel the password keypad.
Logout Trigger Bit	When the specified trigger bit changes from Off to On, the current user level is reset to 0.
Login Timeout	The password keypad will close automatically when it gets no input from the operator for the specified time.



## 3.9. Screens

### 3.9.1. Types of Screens

There are three types of the screen: Normal Screen, Window Screen and Menu Screen.

To create any type of the screen, you can use the following procedures:

- 1) Create a screen. Default is a normal screen. To learn how to create a screen, please see [Section 3.9.2](#) for details.
- 2) Open Screen Properties dialog box. To learn how to open the dialog box, please see [Section 3.9.3](#) for details.
- 3) In the dialog box, select the type you would like the screen to be.

The following table describes how each type of the screen opens, closes and displays.

Types	Description
Normal Screen	<p>A screen that will be shown up when it is selected to be a startup screen or a screen button with open screen/previous screen operation is pressed.</p> <p>Usually the normal screen can not be closed until the other normal screen is opened.</p> <p>The normal screen is also called a main screen that displays only one at a time in the panel. The screen size depends on the panel model and it is fixed.</p>
Window Screen	<p>A screen that appears in the following situation:</p> <ul style="list-style-type: none"> <li>• Screen button with open screen operation is pressed</li> <li>• Selected to be a startup screen</li> <li>• OPEN_WS macro command is used.</li> <li>• Alarm is active or clear if display screen option in the discrete/analog alarm block is selected</li> <li>• Page selector object is used</li> <li>• Custom keypad is needed</li> </ul> <p>Usually the window screen stays on the normal screen until you press the close button on the title bar or use screen button or CLOSE_WS macro command to close. It then disappears.</p> <p>The panel can display many window screens at a time.</p> <p>At runtime the window screen will display on the predefined position at very beginning. If the window screen has the title bar, you can click-and-hold the title bar to move it around in the panel.</p>
Menu Screen	<p>A screen that will be shown up when it is selected to be a startup screen or screen button with open screen operation is pressed.</p> <p>Usually the menu screen stays on the normal screen or window screen until you press anywhere outside the menu screen or use screen button to close. It then disappears.</p> <p>The panel can display one menu screen at a time.</p> <p>The menu screen can slide into the view horizontally from left or right side of the screen. It can also appear by the left or right side of the button and slide upward or downward into the view. Please see <a href="#">Section 5.3.4</a> to learn how to use screen button to set up the position of the menu screen.</p>

### 3.9.2. Creating and Opening Screens

#### ■ Creating Screens

To create a screen, you can use the following procedures:

- 1) Do one of the following:
  - On the Screen menu, click New Screen...
  - In the Project Manager tool window, right-click the panel application > Screens item and then click New Screen... on the popup menu.
- 2) In the New Screen dialog box, type the name and number you want, and hit the ENTER key or click the OK button to validate your choice. The following is an example of the New Screen dialog box.

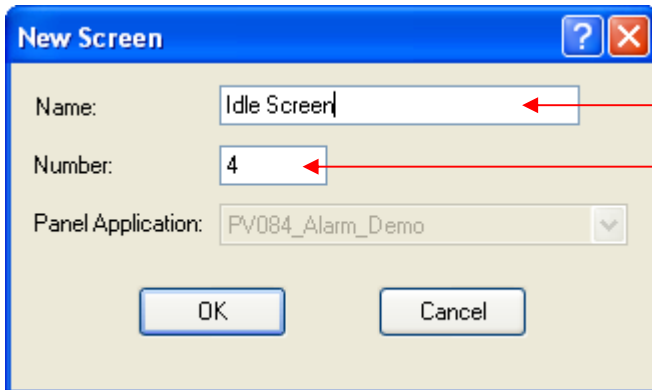

The 'New Screen' dialog box has a blue title bar with a question mark and a close button. It contains three input fields: 'Name' with the text 'Idle Screen', 'Number' with the text '4', and 'Panel Application' with a dropdown menu showing 'PV084\_Alarm\_Demo'. At the bottom are 'OK' and 'Cancel' buttons.

Specify the screen name here. The screen names are case insensitive. For example, consider the names Startup Screen, startup screen to be the same.

Specify the screen number here. The screen number must be between 1 and 7999.

**Note:** In each panel application, both the screen name and the screen number have to be unique.

#### ■ Opening Screens

To open a screen, you can do one of the followings:

- 1) In the Project Manager tool window, double click the screen you want to open
- 2) On the Screen menu, click Open Screen... In the Open Screen dialog box, select one or multiple screens and click Open button to open all the selected screens.

The following is an example of Open Screen dialog box.

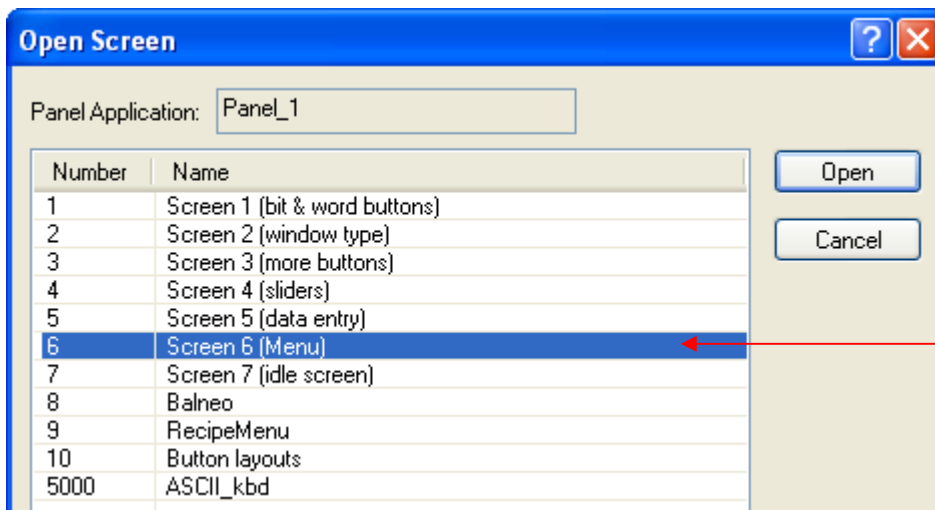

The 'Open Screen' dialog box has a blue title bar with a question mark and a close button. It features a 'Panel Application' dropdown menu set to 'Panel\_1'. Below is a table with columns 'Number' and 'Name'. The row for 'Screen 6 (Menu)' is selected. To the right of the table are 'Open' and 'Cancel' buttons.

Number	Name
1	Screen 1 (bit & word buttons)
2	Screen 2 (window type)
3	Screen 3 (more buttons)
4	Screen 4 (sliders)
5	Screen 5 (data entry)
6	Screen 6 (Menu)
7	Screen 7 (idle screen)
8	Balneo
9	RecipeMenu
10	Button layouts
5000	ASCII_kbd

To select a screen, click the row of that screen in the list.

To select multiple screens, click one row and use Ctrl + Click to add a row to the selection.

To select continuous screens, click one row and hold the Shift key and click the last row.



### ■ Activating Screens after Opening

To uncover any screen that is partially or completely obscured by other screens, you can do one of the followings:

- 1) In the Project Manager tool window, double click the screen which is not on the top.
- 2) On the Window menu, click the screen you need to activate. Or click Windows... to bring out the Windows dialog box. In the Windows dialog box, select the screen and then click Activate button.
- 3) Click anywhere on the screen. If the screens are maximized, click on the title tab of the screen.

### 3.9.3. Setting up a Screen

You can set up the screen with the Screen Properties dialog box.

To set up a screen, right click the panel application > Screens > screen you want to set up in the Project Manager tool window, and then click Properties on the popup menu.

To set up a current screen, an opened screen which is on the top, you can do one of the followings:

- 1) In the Project Manager tool window, double click the current screen.
- 2) Right click the blank area on the current screen, and then click Screen Properties... on the popup menu.
- 3) On the Screen menu, click Screen Properties...

The Screen Properties dialog box contains the following pages. Some of the pages appear only when they are needed.

#### ■ General

Described in [Section 3.10.3.1](#).

#### ■ Background

Described in [Section 3.10.3.2](#).

#### ■ Keys

Described in [Section 3.2.2](#).

#### ■ Open Macro / Close Macro / Cycle Macro

Described in [Section 14.2.6](#).



### 3.9.3.1. General Page

This section describes how to define the general settings for a screen. The following is an example of the General page of the Screen Properties dialog box.

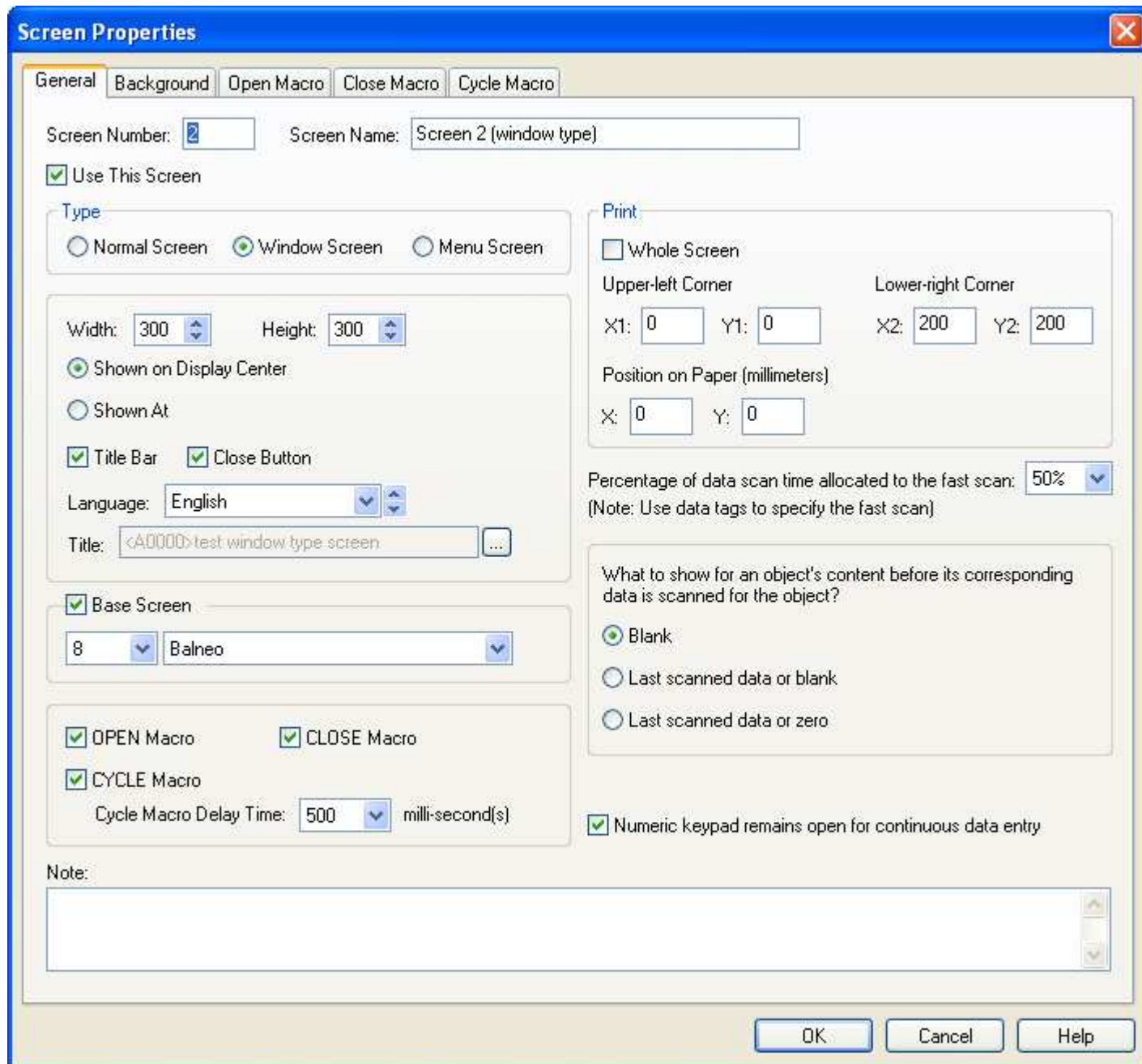

The following table describes each item in the General page.

Property	Description
Screen Number	The number of the screen. It must be between 1 and 7999.
Screen Name	The name of the screen.
Use This Screen	Check this option if you want to use the screen.
Type	Specifies the type of the screen. There are three types: Normal Screen, Window Screen and Menu Screen. Please see <a href="#">Section 3.9.1</a> for details.

Continued



Property		Description
Width		Specifies the width (in pixels) of the screen. This field is available to edit when the Type is Window Screen and Menu Screen.
Height		Specifies the height (in pixels) of the screen. This field is available to edit when the Type is Window Screen and Menu Screen.
Shown on Display Center		Check this option if you want the window screen is shown on display center. This field is available when the Type is Window Screen.
Shown At		Check this option if you want the window screen is shown at the specified position. This field is available when the Type is Window Screen.
	X	Specifies the X coordinate of the window screen's upper-left corner in pixel on the normal screen.
	Y	Specifies the Y coordinate of the window screen's upper-left corner in pixel on the normal screen.
Title Bar		Select this option if you want the window screen to have a title bar to show the specified title when the Type is Window Screen.
Close Button		Select this option if you want the window screen to have a close Button when the Type is Window Screen and the Title Bar field is checked.
Language		Select a language so you can view and edit the settings of the title for that language. This field is available when the Type is Window Screen and Title Bar field is checked.
Title		Specifies the title for the Title Bar. This field is available when the Type is Window Screen and Title Bar field is checked.
Base Screen	<Check Box>	Check this option if you want to have a base screen for the current screen
	<Combo Box>	Specifies the screen to be a base screen. This field is available when the Base Screen is checked.
OPEN Macro		Check this item if you want the screen to have the OPEN macro. An Open Macro is run once when the associated screen is being opened. The target panel will not display the screen until the Open Macro terminates. You can use OPEN macro to initialize global data and settings for the screen.
CLOSE Macro		Check this item if you want the screen to have the CLOSE macro. A Close Macro is run once when the associated screen is being closed. The target panel will not erase the screen until the Close Macro terminates.
CYCLE Macro	<Check Box>	Check this item if you want the screen to have the CYCLE macro. A Cycle Macro is run all the time while the associated screen is open. The target panel runs Cycle Macros cyclically, i.e. it will run a Cycle Macro starting from the first command again each time after it completes the processing of the last command of the macro or when it encounters an END command in the middle of the macro. And the cycle macro terminates immediately if the screen is closed.
	Cycle Macro Delay Time	Specifies the delay time in 0, 100, 200, 300, 400, 500, 600, 700, 800, 900, 1000 milli-second for the cycle macro.
Print	Whole Screen	Check this item if you want to print the whole screen by Command Flag or Function Button or Macro Command
	Upper-left	Specifies the X and Y coordinates in pixel for the upper-left corner of the screen's printing area. The field is available when Whole Screen item is unchecked.
	Lower-Right	Specifies the X and Y coordinates in pixel for the lower-right corner of the screen's printing area. The field is available when Whole Screen item is unchecked.
	Position on Paper	Specifies the X and Y coordinates in millimeters for the position where the specified area of the screen will print on paper..

Continued





Property		Description
Percentage of data scan time allocated to the fast scan		Select the percentage of data scan time allocated to the fast scan among 50%, 66%, 75%, 80%, 86% and 90%. Note: The bigger percentage, the faster data scan time to the tag with fast scan rate, but the slower data scan time to the tag with normal scan rate.
What to show for an object's content before its corresponding data is scanned for the object?	Blank	Select this item to show blank for an object's content before its corresponding data is scanned for the object.
	Last scanned data or blank	Select this item to show last scanned data or blank for an object's content before its corresponding data is scanned for the object.
	Last scanned data or zero	Select this item to show last scanned data or zero for an object's content before its corresponding data is scanned for the object.
Operable under window screen		Check this option to make the screen operable under window screen. This field is available only when the Type is Normal Screen.
Numeric keypad remains open for continuous data entry		Check this option if you want numeric keypad to remain open for continuous data entry.
Note		You can type a note for the screen.

### 3.9.3.2. Background Page

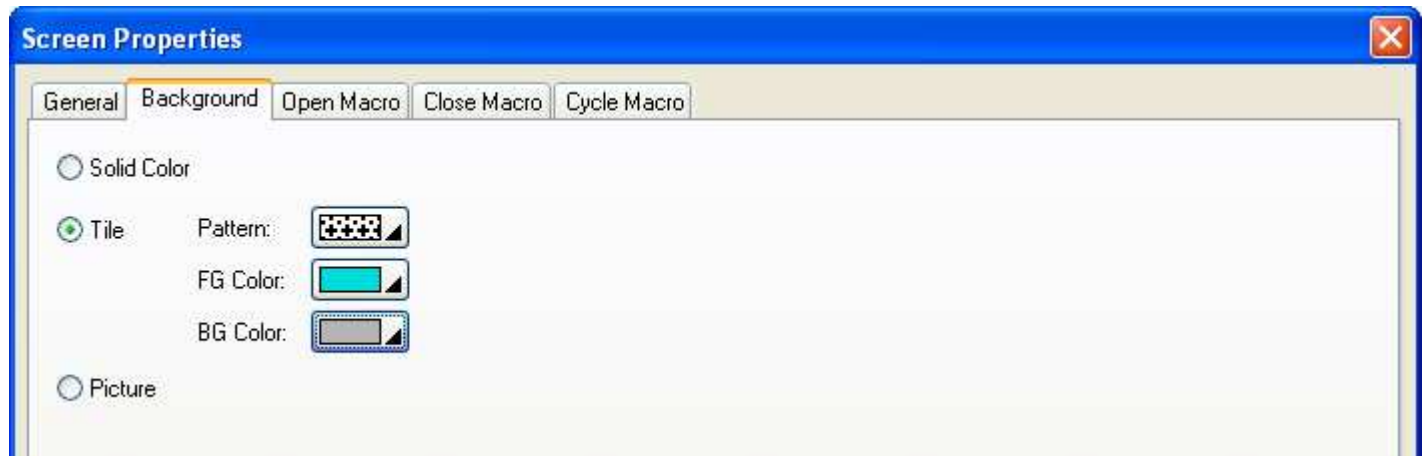
This section describes how to define the background of a screen. The following is an example of the Background page of the Screen Properties dialog box.



The following table describes each item in the Background page.

Property	Description
Solid Color	Check this option if you want the screen background filling with the solid color.
	<Solid Color> Click the corresponding color button to specify the color which is used to fill the background. This item is available when Solid Color option is selected.
Tile	Check this option if you want the screen background filling with the pattern.
	Pattern Specify the pattern which is used to fill the background. Click the corresponding Pattern icon and select a pattern from the Pattern palette. This item is available when Tile option is selected.
	FG Color The color that is used to paint the black part of the pattern. When the solid white pattern is selected, this color is not used. This item is available when Tile option is selected.
	BG Color The color that is used to paint the white part of the pattern. This item is available when Tile option is selected.
Picture	Check this option if you want to have a picture background for the screen.
	<Name> The name of the picture. You can use the drop-down list to select a picture from the picture database. Click  to select a picture file. After the selection, the picture of the selected file is imported and saved in the picture database. Click  to bring up the Select/Import from Library dialog box. Select a picture from a picture library file. After the selection, the selected picture is imported and saved in the picture database.
	Stretch Check this item so the picture can change its size automatically to just fit the screen.



### 3.9.4. Importing/Exporting a Screen

This section describes how to export a screen and import a screen regardless of the panel model and screen size.

#### ■ Importing a screen

- 1) Right-click the panel application > Screens item in the Project Manager tool window to bring out the popup menu and then use the Import Screen... command on the popup menu
- 2) Click the \*.snf file you want to create a new screen from. If you want to open a screen that was saved in a different folder, locate and open the folder first.
- 3) Click Open.

#### ■ Exporting a screen

If you have screen you want to reuse, you can export the screen as a .snf file. You may do the following:

- 1) In the Project Manager tool window, click the screen you would like to export
- 2) Right-click on the screen to display the screen item's "popup menu"; and then click Export Screen..., the fourth menu item.
- 3) If you want to save a macro in a different folder, locate and open the folder first. then click Save.

### 3.9.5. Cutting/Copying/Pasting/Deleting a Screen

#### ■ Copying or Cutting and Pasting a Screen

To copy/cut a screen which is opened and activated, right click the blank area on the screen, and then click Copy Screen/Cut Screen on the popup menu or use the Copy Screen/Cut Screen command On the Screen menu.

After Copying or Cutting, you can paste the screen by right clicking the blank area on any of the screen and then using Paste Screen command on the popup menu or using the Paste Screen command On the Screen menu.

#### ■ Deleting a Screen

To delete a screen which is opened and activated, right click the blank area on the screen, and then click Delete Screen on the popup menu or use the Delete Screen command on the Screen menu.

To delete a screen from project manager tool window, local the screen you would like to delete and then right-click on the screen node to use the Delete command on the popup menu. You will be asked to confirm the deleting operation.

### 3.9.6. Saving Screens as Pictures

This section describes how to save screens as pictures.

#### ■ Saving a screen as a picture

To save current screen as the bmp or jpg file, you can do one of the followings.

- 1) Open and activate the screen as a current screen
  - 2) Right click the anywhere on the current screen, and then click Save Current Screen as Picture... on the popup menu.
- or -

On the Screen menu, click Save Current Screen as Picture...

#### ■ Saving multiple screens as pictures

You can also use Save Screens as Pictures dialog box to save a screen or multiple screens as bmp or jpg files. To open the dialog box, click Save Screens as Pictures... on the Screen menu.

The following is an example of the Save Screens as Pictures dialog box.

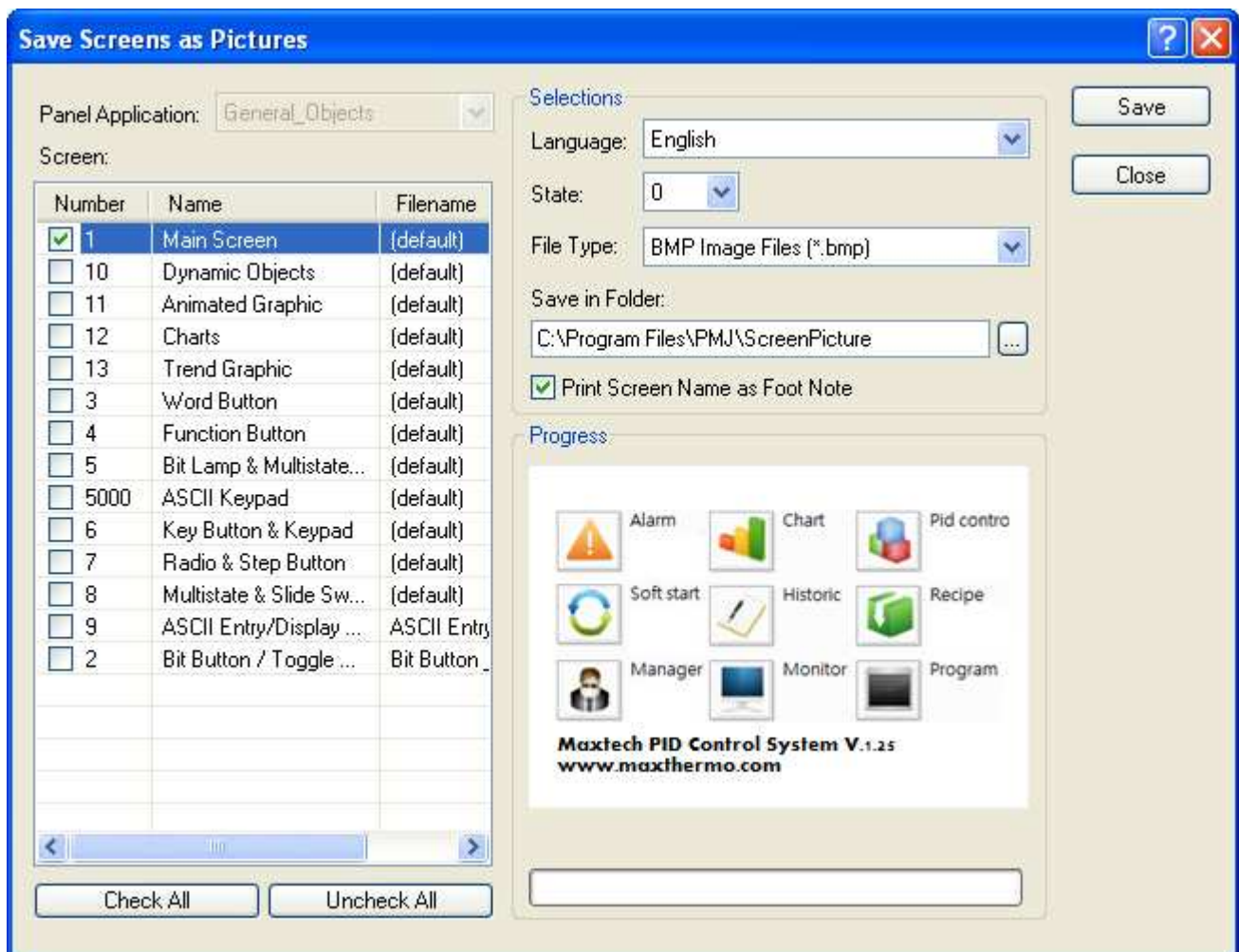



The following table describes each item in the dialog box.

Property		Description								
Panel Application		The application Name.								
Screen		<p>The screen list shows all the screens in the panel application. You can click the column header to sort the items.</p> <p>The following table describes each column in the screen list.</p> <table border="1"> <thead> <tr> <th>Column</th> <th>Description</th> </tr> </thead> <tbody> <tr> <td>Number</td> <td>The screen number. Check the option before the screen number if you want to save the screen as a picture file.</td> </tr> <tr> <td>Name</td> <td>The screen name.</td> </tr> <tr> <td>Filename</td> <td>The Filename. The default filename is Screen Name+Language Name+S+State Number. Note: If any of the characters such as \:*\?"&lt;&gt;  in the screen name, they will be converted to underscore(_).</td> </tr> </tbody> </table>	Column	Description	Number	The screen number. Check the option before the screen number if you want to save the screen as a picture file.	Name	The screen name.	Filename	The Filename. The default filename is Screen Name+Language Name+S+State Number. Note: If any of the characters such as \:*\?"<>  in the screen name, they will be converted to underscore(_).
Column	Description									
Number	The screen number. Check the option before the screen number if you want to save the screen as a picture file.									
Name	The screen name.									
Filename	The Filename. The default filename is Screen Name+Language Name+S+State Number. Note: If any of the characters such as \:*\?"<>  in the screen name, they will be converted to underscore(_).									
Check All		Click the button to check all the screens.								
Uncheck All		Click the button to uncheck all the screens.								
Selections	Language	The language that displays the text of objects.								
	State	The state that displays the state of objects.								
	File Type	Select the file type. There are two types: bmp and jpg.								
	Save in Folder	Specifies the folder you want to locate the files. If the file exists in the folder, it will be replaced by the new one.								
	Print Screen Name as Foot Note	Check this option if you want to display general screen information as foot note. The format of the foot note is Screen Name(#Screen Number); Screen WidthXScreen Height.								
Progress	<Screen View>	Show the selected screen or the screen which is saving. To select a screen, click the row of that screen in the screen list.								
	<Progress Bar>	Show the saving progress after the Save button is clicked.								
Save		Click the button to save all the selections with the specified conditions.								
Close		Click the button to exit the dialog box.								



## CHAPTER 4

# DESIGNING SCREENS

<b>4.1. Drawing Basic Shapes .....</b>	<b>1</b>
4.1.1. Drawing Dots .....	2
4.1.2. Drawing Lines .....	3
4.1.3. Drawing Polylines .....	5
4.1.4. Drawing Rectangles.....	8
4.1.5. Drawing Circles.....	11
4.1.6. Drawing Ellipses .....	13
4.1.7. Drawing Arcs.....	15
4.1.8. Drawing Pie Shapes .....	16
4.1.9. Drawing Polygons.....	18
4.1.10. Drawing Text Objects .....	21
4.1.11. Drawing Picture Objects .....	24
4.1.12. Drawing Scales .....	26
4.1.13. Drawing Tables.....	28
<b>4.2. Editing Objects .....</b>	<b>32</b>
4.2.1. Selecting and De-selecting the Objects .....	32
4.2.2. Basic Operations with the Selected Area .....	32
4.2.3. Duplicating Objects .....	34
4.2.4. Aligning Objects .....	35
4.2.5. Making Objects Same Size .....	36
4.2.6. Arranging the Order of Objects .....	36
<b>4.3. Designing Object Appearance .....</b>	<b>38</b>
4.3.1. Selecting a Color .....	40
4.3.2. Selecting a Pattern .....	41
4.3.3. Selecting a Graphical Shape .....	41
4.3.4. Setting up the Shape of an Object.....	44
4.3.5. Label Settings.....	45
4.3.6. Text Settings .....	49
4.3.7. Picture Settings.....	51
4.3.8. External Label Settings.....	53



<b>4.4. Setting up Objects .....</b>	<b>55</b>
4.4.1. States of Objects.....	55
4.4.2. Operation Options of Objects.....	57
4.4.3. Address Settings.....	58
4.4.4. Scale Settings.....	61
4.4.5. Advanced Settings.....	63
4.4.6. Visibility Settings .....	65



## 4.1. Drawing Basic Shapes

PM Designer provides a drawing tool you can use to create simple or elaborate drawing shapes such as lines, rectangles, circles, arcs etc.

To create a drawing shape, click the shape on the Draw Toolbar (See [Section 1.3.2.3 Draw Toolbar](#) for details), or use the command on the Draw menu (See [Section 1.3.1.3 Draw menu](#) for details) and then move the mouse to the position you want to place the shape and click the left button. To set up a drawing shape, double-click the shape to bring up the corresponding properties dialog that you can set up the color and style of the line/outlined, pattern, FG/BG Color...of the shape.

**Note:** If you don't see the Draw Toolbar as below in the lower left corner of the program window, please click Draw Toolbar command on the View menu.



The following is a sample of the basic shapes:

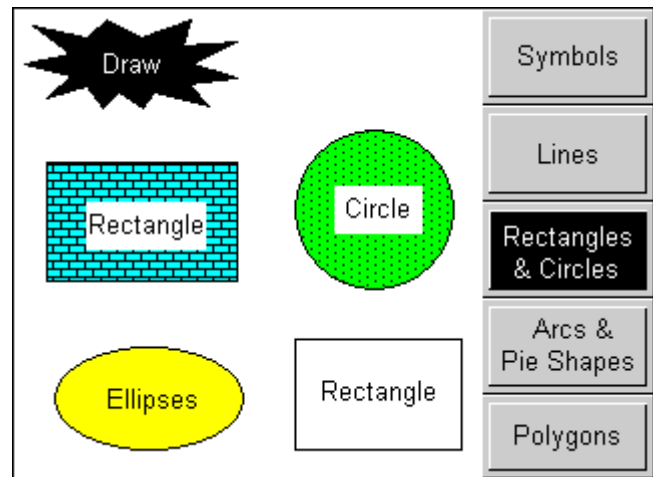
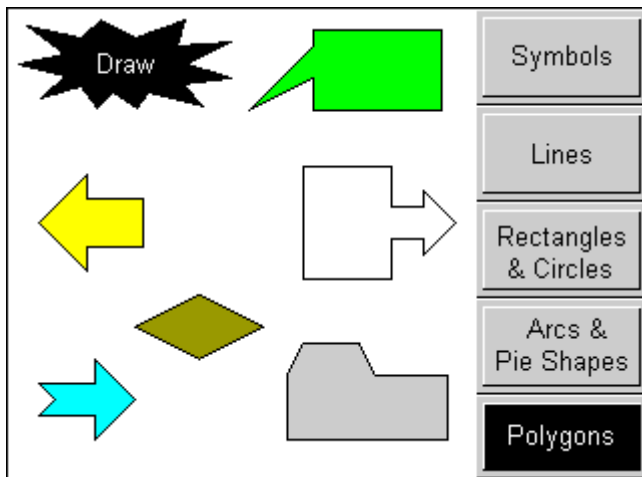

### 4.1.1. Drawing Dots

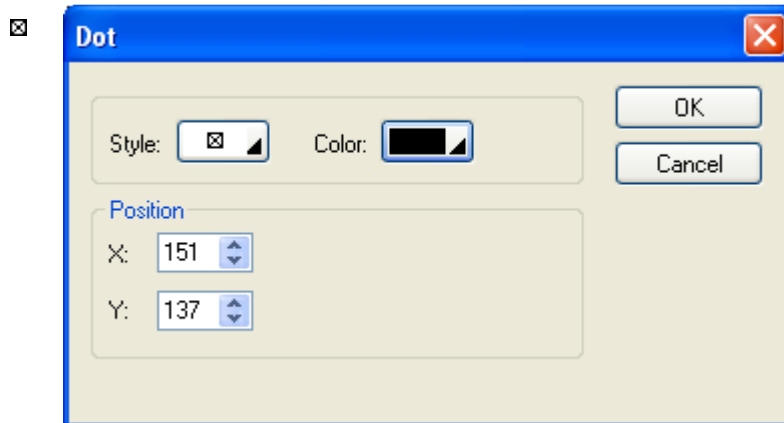

1. In the Draw menu or Draw toolbar, click **Dot** .
2. Move the cursor onto the screen where you want to draw a dot. A dot with default settings will display and move along with the cursor.
3. Click the desired position on the screen to place the dot. The center of the dot will be at the clicked position.
4. Double-click the dot to bring up the Dot dialog box and then modify the settings of the dot. The following is an example of the Dot dialog box.

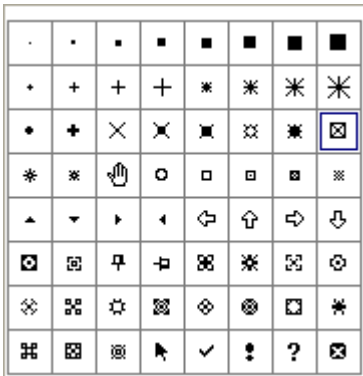

The following table describes each property in the Dot dialog box.



Property	Description	
Style	Select one of the dot styles listed below: 	
Color	Specifies the dot color.	
Position	X	Specifies the X coordinate of the upper-left corner of the dot.
	Y	Specifies the Y coordinate of the upper-left corner of the dot.

5. You can click the following icons in the Draw toolbar to modify the properties of the dot.

Click Icon	To
	Select a style for the dot.
	Select a color for the dot.



### 4.1.2. Drawing Lines

1. In the Draw menu or Draw toolbar, click Line  to draw a straight line. You can also click **Horizontal Line**  to draw a horizontal line or click **Vertical Line**  to draw a vertical line.
2. Move the cursor onto the screen where you want to draw a line. A line with default settings will display and move along with the cursor.
3. Click the desired position on the screen to place the line. The start point of the line will be at the clicked position.
4. Drag the handle at the start point to adjust the position of the start point. Drag the handle at the end point to adjust the position of the end point.

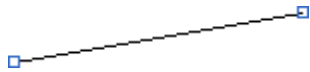

The picture on the left shows the two handles of a line. Position the mouse pointer over one of the handles. When the cursor turns to be , drag the handle until the line has the length and slope you want.

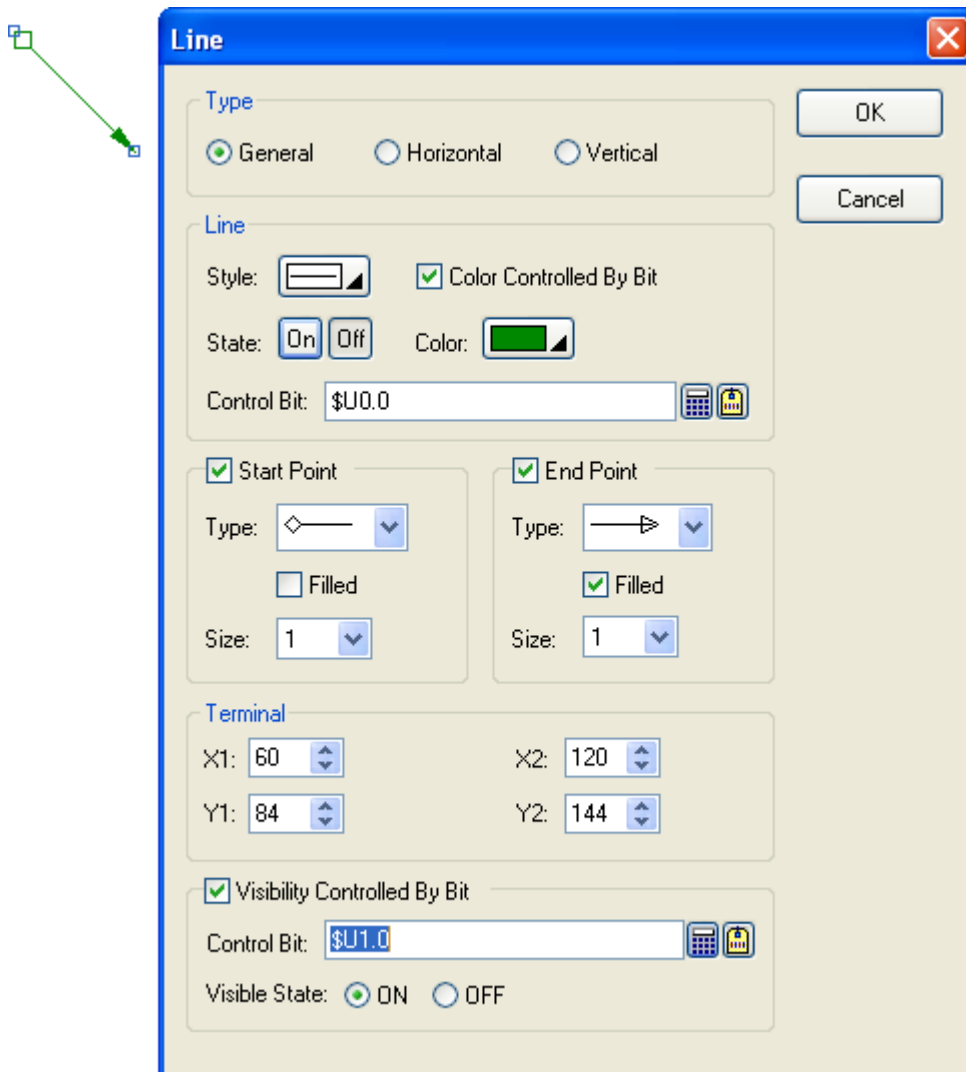

5. Left-click and hold down the mouse button until the cursor becomes cross icon  to move the line.
6. Double-click the line to bring up the Line dialog box and then modify the settings of the line. The following is a sample of Line dialog box.

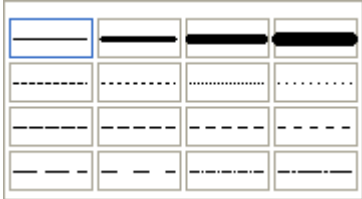
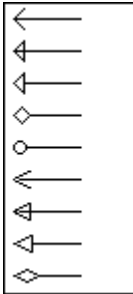
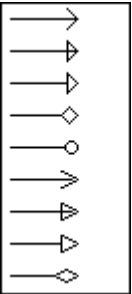

The following table describes each property in the Line dialog box.

Property		Description
Type		Specifies the type of the line: General, Horizontal, or Vertical.
Line	Style	Clicks the button to select the line style from the dropdown window shown on the right: 
	Color Controlled By Bit	Check this option if the color of the line will be controlled by the specified bit.
	State	Select the state that you want to view or define the color for.
	Color	Specifies the line color for the selected state.
	Control Bit	Specifies the bit that controls the color. Click  to enter the bit address. Click  to enter the bit tag.
Start / End Point	Start/End Point	Select this option if you want the line to have a shape at the start/end point.
	Type	Clicks the dropdown list to select the type for Start/End Point  Start Point Type:  End Point Type: 
	Filled	Select this option if you want the shape to be filled with the line color.
	Size	Specifies the shape size.
Terminal	X1	The X coordinate of the start point.
	Y1	The Y coordinate of the start point.
	X2	The X coordinate of the end point.
	Y2	The Y coordinate of the end point.
Visibility Control	Visibility Controlled By Bit	Check this option if the line will be shown or hidden by the specified bit.
	Control Bit	Specifies the bit that shows or hides the object. Click  to enter the bit address. Click  to enter the bit tag.
	Visible State	Specifies the state (On or Off) that makes the line visible.

7. You can click the following icons in the Draw toolbar to modify the properties of the line.





Click Icon	To
	Select a style for the line.
	Select a color for the line.

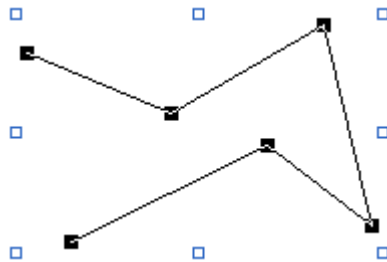

### 4.1.3. Drawing Polylines

1. In the Draw menu or Draw toolbar, click **Polyline**  to draw a polyline.
2. Move the cursor onto the screen where you want to draw a polyline and click the position where you want the start point of the polyline to be at.
3. Continue clicking on the screen to place as many points needed for nodes in the polyline.
4. Right-click to place the last point for the polyline and complete the polyline.
5. Drag one blue handle of the polyline at a time to resize the polyline.
6. Drag one black handle of the polyline at a time to adjust the node positions of the polyline.



The picture on the left shows all the blue and black handles of a polyline. Position the mouse pointer over one of the handles. When the cursor turns to be  or  or  or , drag the handle until the polyline is the shape and size you want.

7. Right-click anywhere on the polyline and use the Insert Point command on the object popup menu to insert a new point for the polyline. Or right-click the existing point of the polyline and use the Delete Point command on the object popup menu to delete the point.

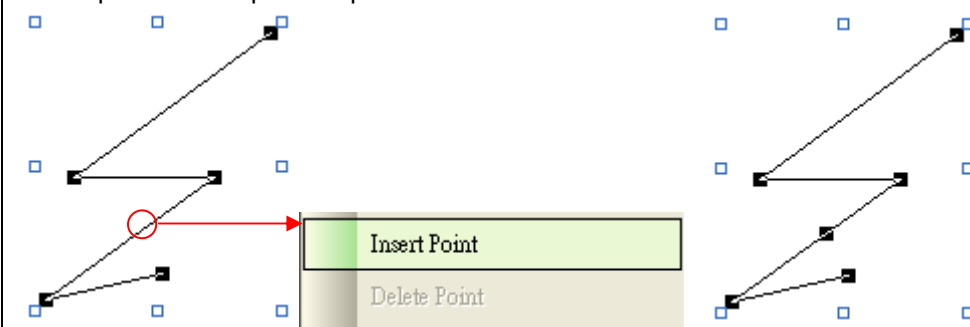
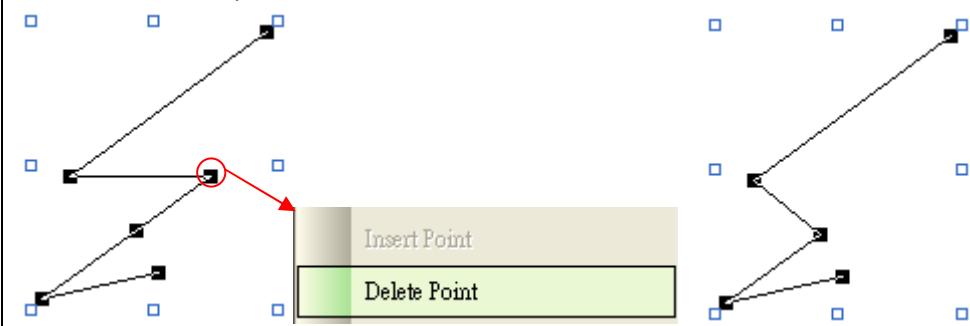
Popup menu	Description
Insert Point	<p>Add a point at the specified position.</p> 
Delete Point	<p>Delete a selected point.</p> 

8. Double-click the polyline to bring up the Polyline dialog box and then modify the settings of the polyline. The following is a sample of Polyline dialog box.

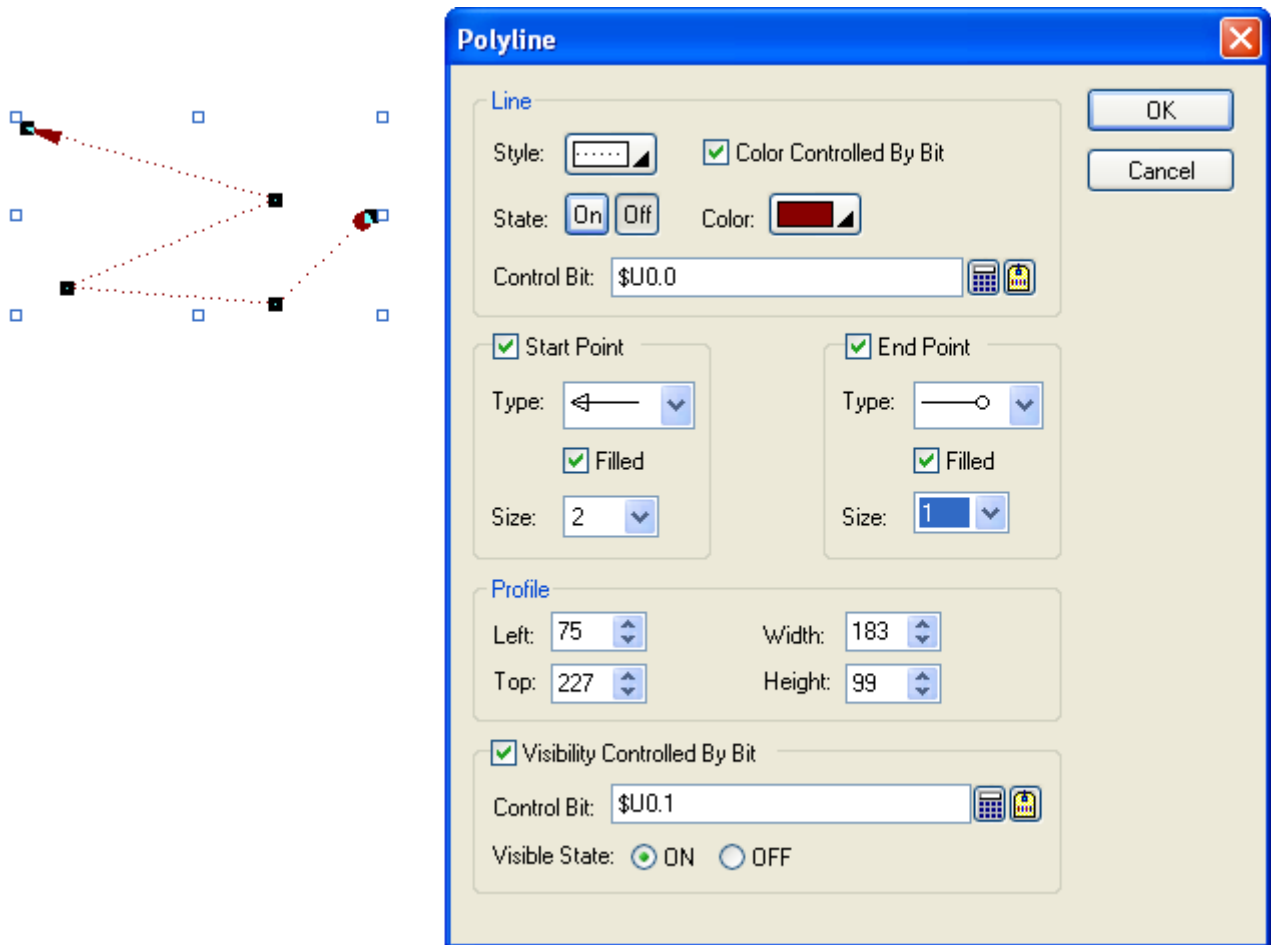



The following table describes each property in the Polyline dialog box.



Property		Description
Line	Style	Specifies the style of the polyline.
	Color Controlled By Bit	Check this option if the color of the polyline will be controlled by the specified bit.
	State	Select the state that you want to view or define the color for.
	Color	Specifies the line color for the selected state.
	Control Bit	Specifies the bit that controls the color. Click  to enter the bit address. Click  to enter the bit tag.
Start Point	Start Point	Select this option if you want the polyline to have a shape at the start point.
	Type	Specifies the shape type.
	Filled	Select this option if you want the shape to be filled with the line color.
	Size	Specifies the shape size.
End Point	End Point	Select this option if you want the polyline to have a shape at the end point.
	Type	Specifies the shape type.
	Filled	Select this option if you want the shape to be filled with the line color.
	Size	Specifies the shape size.

Continued



Property		Description
Profile	Left	The X coordinate of the upper-left corner of the bounding rectangle of the polyline.
	Top	The Y coordinate of the upper-left corner of the bounding rectangle of the polyline.
	Width	The width of the bounding rectangle of the polyline.
	Height	The height of the bounding rectangle of the polyline.
Visibility Control	Visibility Controlled By Bit	Check this option if the polyline will be shown or hidden by the specified bit.
	Control Bit	Specifies the bit that shows or hides the polyline. Click  to enter the bit address. Click  to enter the bit tag.
	Visible State	Specifies the state (On or Off) that makes the line visible.

9. You can click the following icons in the Draw toolbar to modify the properties of the polyline.

Click Icon	To
	Select a style for the polyline.
	Select a color for the polyline.



### 4.1.4. Drawing Rectangles

- In the Draw menu or Draw toolbar, click **Rectangle** to draw a normal rectangle. You can also click **Round Rectangle** to draw a round rectangle or click **Clipped Rectangle** to draw a clipped rectangle.
- Move the cursor onto the screen where you want to draw a rectangle. A rectangle with default settings will display and move along with the cursor.
- Click the desired position on the screen to place the rectangle. The upper-left corner of the rectangle will be at the clicked position.
- Drag one handle of the rectangle at a time to resize the rectangle.

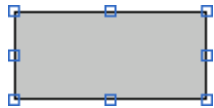

The picture on the left shows the eight handles of a rectangle. Position the mouse pointer over one of the handles. When the cursor turns to be or or or , drag the handle until the rectangle is the shape and size you want.

- Double-click the rectangle to bring up the Rectangle dialog box and then modify the settings of the rectangle. The following is a sample of Rectangle dialog box.

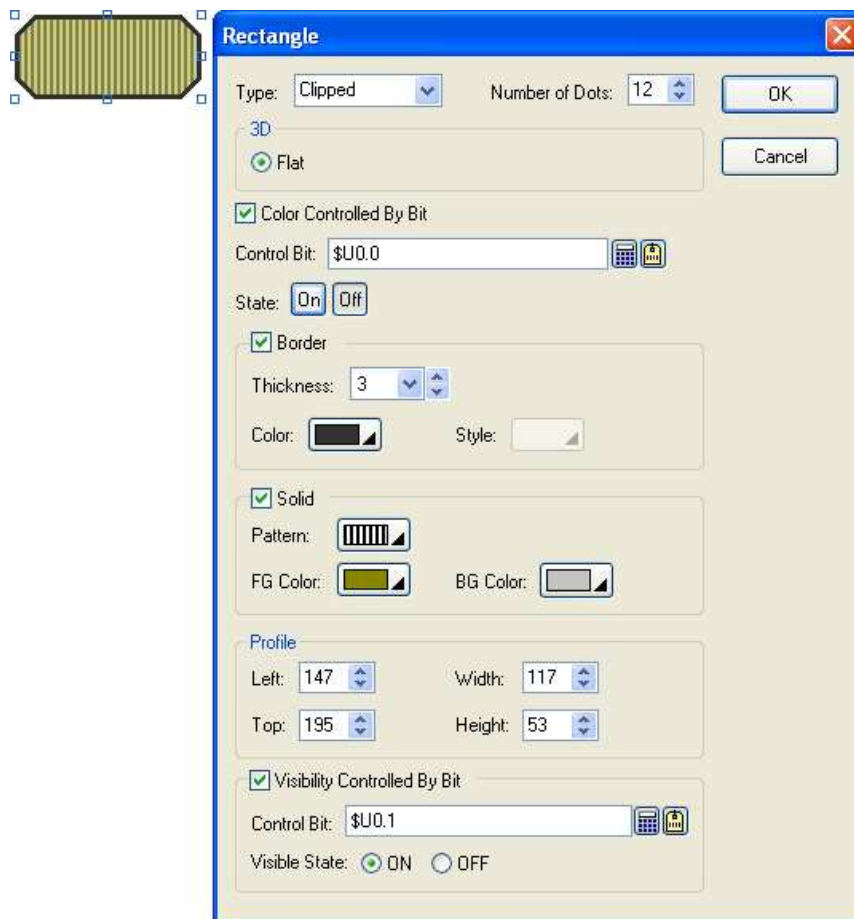

The following table describes each property in the Rectangle dialog box.

Property	Description		
Type	Specifies the type of the rectangle. There are three types: Normal, Round, or Clipped.		
	<b>Normal</b>	<b>Round</b>	<b>Clipped</b>



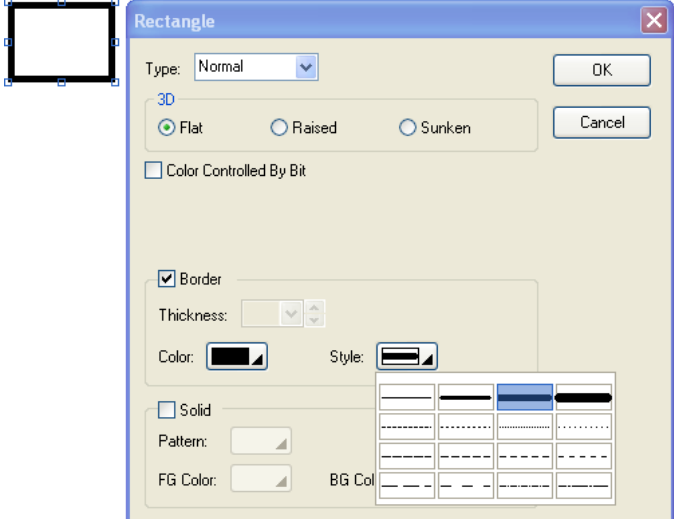
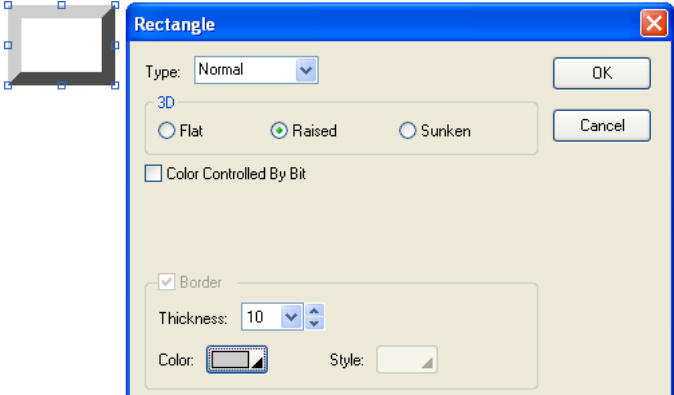
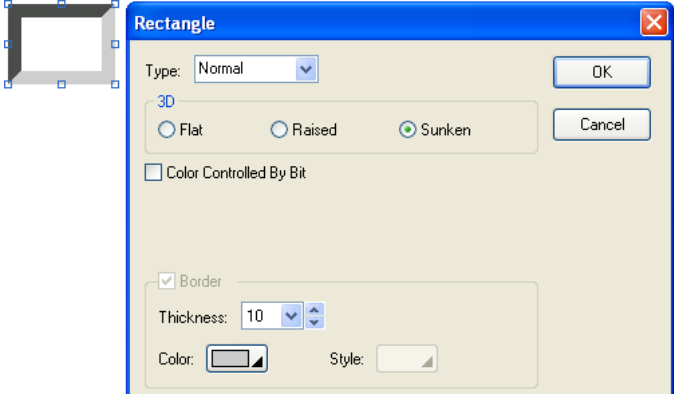

Continued







Property	Description		
Number of Dots	Specifies the size of the clipped corners if the rectangle is a clipped rectangle. Specifies the radius of the round corners if the rectangle is a round rectangle.		
3D	Specifies the 3D visual effect for the rectangle. There are three effects: Flat, Raised, or Sunken.		
	Effects	Samples	Description
	Flat		<p>You can specify the Color and Style for the Border if it is selected.</p> <p>Thickness field is not available when flat is selected.</p>
	Raised		<p>You can specify the color for the top and left edges. And PM Designer will darken the specified color and draw the bottom and right edges for you.</p> <p>Border and Style field is not available when Raised is selected.</p>
Sunken		<p>You can specify the color for the bottom and right edges. And PM Designer will darken the specified color and draw the top and left edges for you.</p> <p>Border and Style field is not available when Raised is selected.</p>	

Continued







Property		Description
Color Control	Color Controlled By Bit	Check this option if the color of the rectangle will be controlled by the specified bit.
	Control Bit	Specifies the bit that controls the color. Click  to enter the bit address. Click  to enter the bit tag.
	State	Select the state that you want to view or define the colors for.
Border	Border	Check this option if you want the rectangle to have border.
	Thickness	Specifies the thickness of the border.
	Color	Specifies the border color for the selected state.
	Style	Select a line style for the border.
Solid	Solid	Check this option if you want the rectangle to be solid. A solid rectangle is filled with the specified pattern and colors. This field is available when the Border is selected.
	Pattern	Specifies the fill pattern for the selected state.
	FG Color	Specifies the color for the selected state that will be used for painting the black part of the fill pattern.
	BG Color	Specifies the color for the selected state that will be used for painting the white part of the fill pattern.
Profile	Left	The X coordinate of the upper-left corner of the rectangle.
	Top	The Y coordinate of the upper-left corner of the rectangle.
	Width	The width of the rectangle.
	Height	The height of the rectangle.
Visibility Control	Visibility Controlled By Bit	Check this option if the rectangle will be shown or hidden by the specified bit.
	Control Bit	Specifies the bit that shows or hides the rectangle. Click  to enter the bit address. Click  to enter the bit tag.
	Visible State	Specifies the state (On or Off) that makes the rectangle visible.

6. You can click the following icons in the Draw toolbar to modify the properties of the rectangle.

Click Icon	To
	Select a line style for the border.
	Select a color for the border.
	Select a color for painting the white part of the fill pattern.
	Select a pattern for the fill pattern.
	Select a color for painting the black part of the fill pattern.

### 4.1.5. Drawing Circles

1. In the Draw menu or Draw toolbar, click **Circle**  to draw a circle.
2. Move the cursor onto the screen where you want to draw a circle. A circle with default settings will display and move along with the cursor.
3. Click the desired position on the screen to place the circle. The center of the circle will be at the clicked position.
4. Position the mouse pointer over the handle on the edge of the circle. When the cursor turns to be  or , drag the handle until the circle is the size you want.
5. Position the mouse pointer over the handle on the center of the circle. When the cursor turns to be , left-click the center and hold down the button to move the circle.

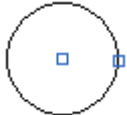

The picture on the left shows the two handles of a circle.



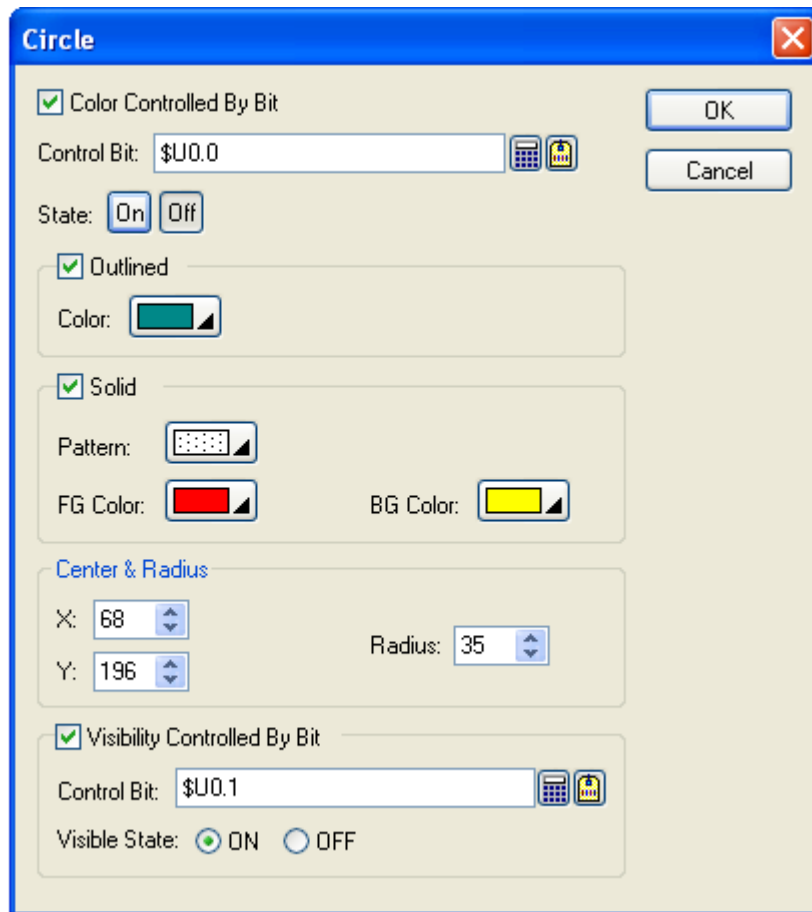
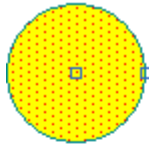

6. Double-click the circle to bring up the Circle dialog box and then modify the settings of the circle.

The following is a sample of Rectangle dialog box.









The following table describes each property in the Circle dialog box.

Property		Description
Color Control	Color Controlled By Bit	Check this option if the color of the circle will be controlled by the specified bit.
	Control Bit	Specifies the bit that controls the color. Click  to enter the bit address. Click  to enter the bit tag.
	State	Select the state that you want to view or define the colors for.
Outline	Outlined	Check this option if you want the circle to be outlined.
	Color	Specifies the outline color for the selected state.
Solid	Solid	Check this option if you want the circle to be solid. A solid circle is filled with the specified pattern and colors.
	Pattern	Specifies the fill pattern for the selected state.
	FG Color	Specifies the color for the selected state that will be used for painting the black part of the fill pattern.
	BG Color	Specifies the color for the selected state that will be used for painting the white part of the fill pattern.
Profile	X	The X coordinate of the center of the circle.
	Y	The Y coordinate of the center of the circle.
	Radius	The radius of the circle.
Visibility Control	Visibility Controlled By Bit	Check this option if the circle will be shown or hidden by the specified bit.
	Control Bit	Specifies the bit that shows or hides the circle. Click  to enter the bit address. Click  to enter the bit tag.
	Visible State	Specifies the state (On or Off) that makes the circle visible.

7. You can click the following icons in the Draw toolbar to modify the properties of the circle.





Click Icon	To
	Select a color for the outline.
	Select a color for painting the white part of the fill pattern.
	Select a pattern for the fill pattern.
	Select a color for painting the black part of the fill pattern.

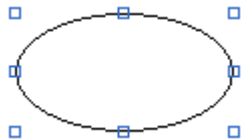

### 4.1.6. Drawing Ellipses

1. In the Draw menu or Draw toolbar, click **Ellipse**  to draw an ellipse.
2. Move the cursor onto the screen where you want to draw an ellipse. An ellipse with default settings will display and move along with the cursor.
3. Click the desired position on the screen to place the ellipse. The upper-left corner of the bounding rectangle of the ellipse will be at the clicked position.
4. Drag one handle of the ellipse at a time to resize the ellipse.



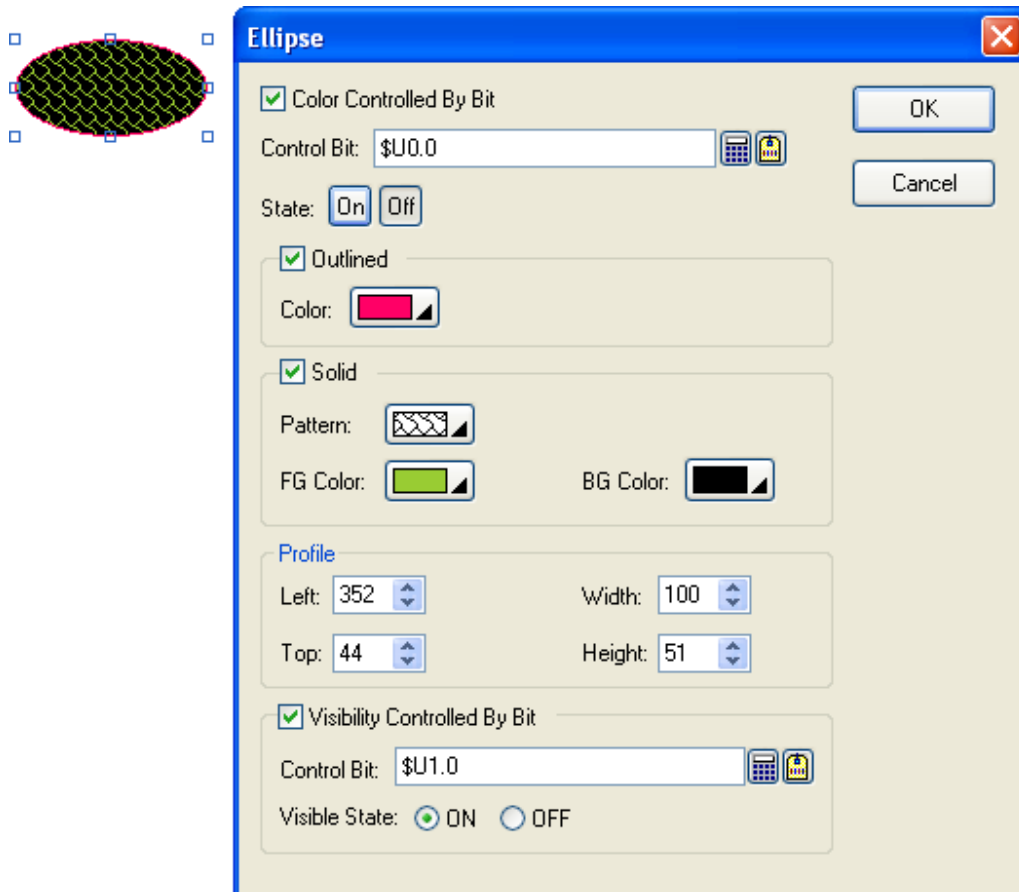

The picture on the left shows the eight handles of an ellipse. Position the mouse pointer over one of the handles. When the cursor turns to be  or  or  or , drag the handle until the rectangle is the shape and size you want.

5. Double-click the ellipse to bring up the Ellipse dialog box and then modify the settings of the ellipse. The following is a sample of the Ellipse dialog box.





The following table describes each property in the Ellipse dialog box.





Property		Description
Color Control	Color Controlled By Bit	Check this option if the color of the ellipse will be controlled by the specified bit.
	Control Bit	Specifies the bit that controls the color. Click  to enter the bit address. Click  to enter the bit tag.
	State	Select the state that you want to view or define the colors for.

Continued



Property		Description
Outline	Outlined	Check this option if you want the ellipse to be outlined.
	Color	Specifies the outline color for the selected state.
Solid	Solid	Check this option if you want the ellipse to be solid. A solid ellipse is filled with the specified pattern and colors.
	Pattern	Specifies the fill pattern for the selected state.
	FG Color	Specifies the color for the selected state that will be used for painting the black part of the fill pattern.
	BG Color	Specifies the color for the selected state that will be used for painting the white part of the fill pattern.
Profile	Left	The X coordinate of the upper-left corner of the bounding rectangle of the ellipse.
	Top	The Y coordinate of the upper-left corner of the bounding rectangle of the ellipse.
	Width	The width of the bounding rectangle of the ellipse.
	Height	The height of the bounding rectangle of the ellipse.
Visibility Control	Visibility Controlled By Bit	Check this option if the ellipse will be shown or hidden by the specified bit.
	Control Bit	Specifies the bit that shows or hides the ellipse. Click  to enter the bit address. Click  to enter the bit tag.
	Visible State	Specifies the state (On or Off) that makes the ellipse visible.

6. You can click the following icons in the Draw toolbar to modify the properties of the ellipse.

Click Icon	To
	Select a color for the outline.
	Select a color for painting the white part of the fill pattern.
	Select a pattern for the fill pattern.
	Select a color for painting the black part of the fill pattern.





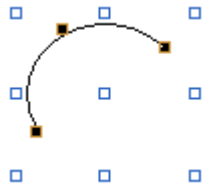

### 4.1.7. Drawing Arcs

1. In the Draw menu or Draw toolbar, click **Arc**  to draw an arc.
2. Move the cursor onto the screen where you want to draw an arc. An arc with default settings will display and move along with the cursor.
3. Click the desired position on the screen to place the arc. The upper-left corner of the bounding rectangle of the arc will be at the clicked position.
4. Drag one handle of the arc at a time to change the shape of the arc.



The picture on the left shows the handles of an arc. The blue handles are for shaping the arc. The black handles of the two ends of the arc are for changing the ends' angles. The black handle at the center of the arc is for forcing the arc to be a part of a circle.

Position the mouse pointer over one of the handles. When the cursor turns to be  or  or  or , drag the handle until the arc is the shape and size you want.

5. Double-click the arc to bring up the Arc dialog box and then modify the settings of the arc.

The following is a sample of Arc dialog box.

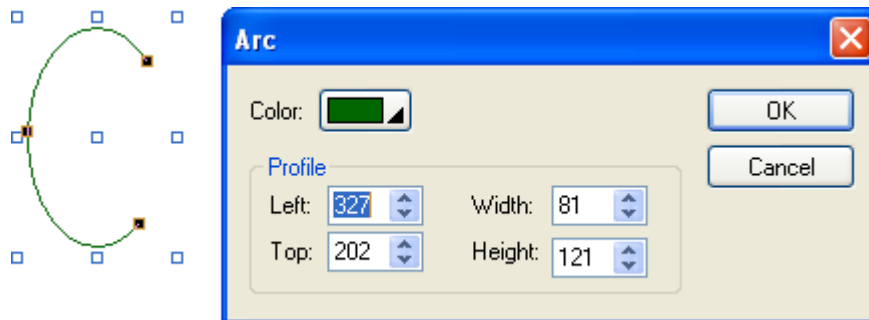

The following table describes each property in the Arc dialog box.

Property		Description
Color		Specifies the color of the arc.
Profile	Left	The X coordinate of the upper-left corner of the bounding rectangle of the arc.
	Top	The Y coordinate of the upper-left corner of the bounding rectangle of the arc.
	Width	The width of the bounding rectangle of the arc.
	Height	The height of the bounding rectangle of the arc.

6. You can click the following icons in the Draw toolbar to modify the properties of the arc.

Click Icon	To
	Select a color for the arc.





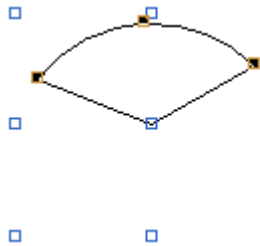

### 4.1.8. Drawing Pie Shapes

1. In the Draw menu or Draw toolbar, click **Pie**  to draw a pie shape.
2. Move the cursor onto the screen where you want to draw a pie shape. A pie shape with default settings will display and move along with the cursor.
3. Click the desired position on the screen to place the pie shape. The upper-left corner of the bounding rectangle of the pie shape will be at the clicked position.
4. Drag one handle of the pie shape at a time to change the pie shape.



The picture on the left shows the handles of a pie shape. The blue handles are for changing the pie shape. The black handles of the two ends of the arc are for changing the ends' angles. The black handle at the center of the arc is for forcing the arc to be a part of a circle.

Position the mouse pointer over one of the handles. When the cursor turns to be  or  or  or , drag the handle until the pie is the shape and size you want.

5. Double-click the pie shape to bring up the Pie dialog box and then modify the settings of the pie shape.

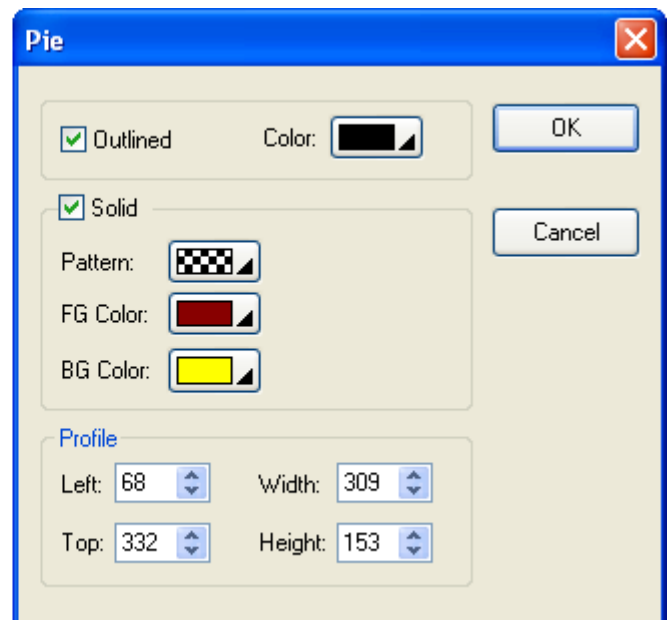
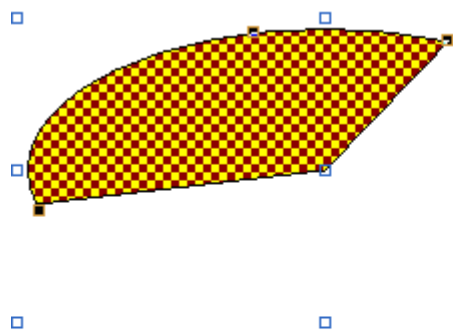





The following table describes each property in the Pie dialog box.

Property		Description
Outline	Outlined	Check this option if you want the pie shape to be outlined.
	Color	Specifies the outline color.
Solid	Solid	Check this option if you want the pie shape to be solid. A solid pie shape is filled with the specified pattern and colors.
	Pattern	Specifies the fill pattern.
	FG Color	Specifies the color that will be used for painting the black part of the fill pattern.
	BG Color	Specifies the color that will be used for painting the white part of the fill pattern.
Profile	Left	The X coordinate of the upper-left corner of the bounding rectangle of the pie shape.
	Top	The Y coordinate of the upper-left corner of the bounding rectangle of the pie shape.
	Width	The width of the bounding rectangle of the pie shape.
	Height	The height of the bounding rectangle of the pie shape.

6. You can click the following icons in the Draw toolbar to modify the properties of the pie shape





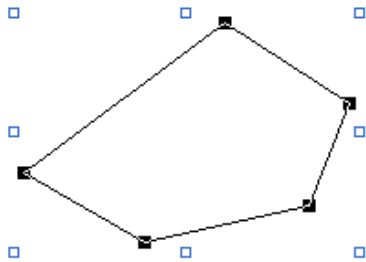

Click Icon	To
	Select a color for the outline.
	Select a color for painting the white part of the fill pattern.
	Select a pattern for the fill pattern.
	Select a color for painting the black part of the fill pattern.

### 4.1.9. Drawing Polygons

1. In the Draw menu or Draw toolbar, click **Polygon**  to draw a polygon.
2. Move the cursor onto the screen where you want to draw a polygon and click the position where you want the first vertex of the polygon to be at.
3. Continue clicking on the screen to place as many points needed for vertices in the polygon.
4. Right-click to place the last vertex for the polygon and complete the polygon.
5. Drag one handle of the polygon at a time to resize the polygon.
6. Drag one black handle of the polygon at a time to adjust the vertex positions of the polygon.



The picture on the left shows the handles of a polygon. The blue handles are for resizing the polygon. The black handles are for moving the vertices of the polygon.

Position the mouse pointer over one of the handles. When the cursor turns to be  or  or  or , drag the handle until the polygon is the shape and size you want.

7. Right-click anywhere on the polygon and use the Insert Point command on the object popup menu to insert a new point for the polygon. Or right-click the existing point of the polygon and use the Delete Point command on the object popup menu to delete the point.

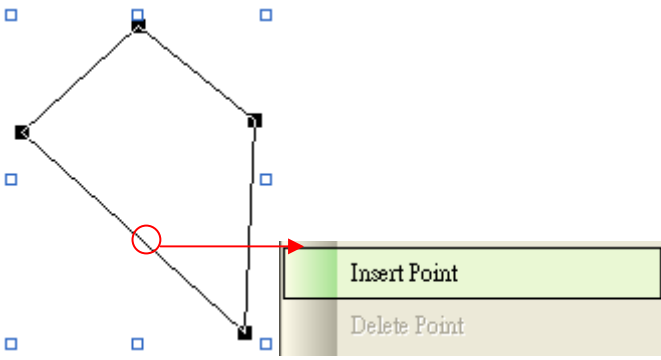
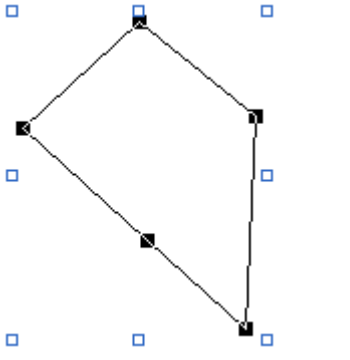
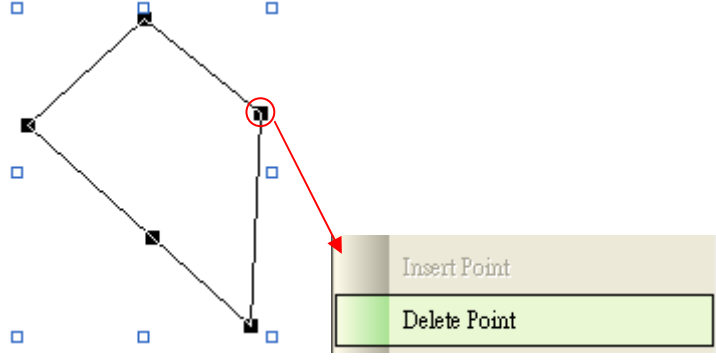
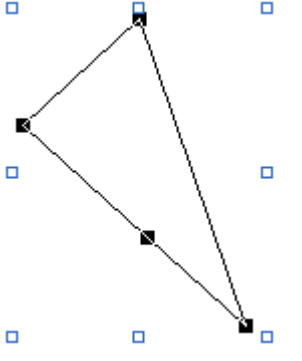
Popup menu	Description	
Insert Point		
Delete Point		



8. Double-click the polygon to bring up the Polygon dialog box and then modify the settings of the polygon.

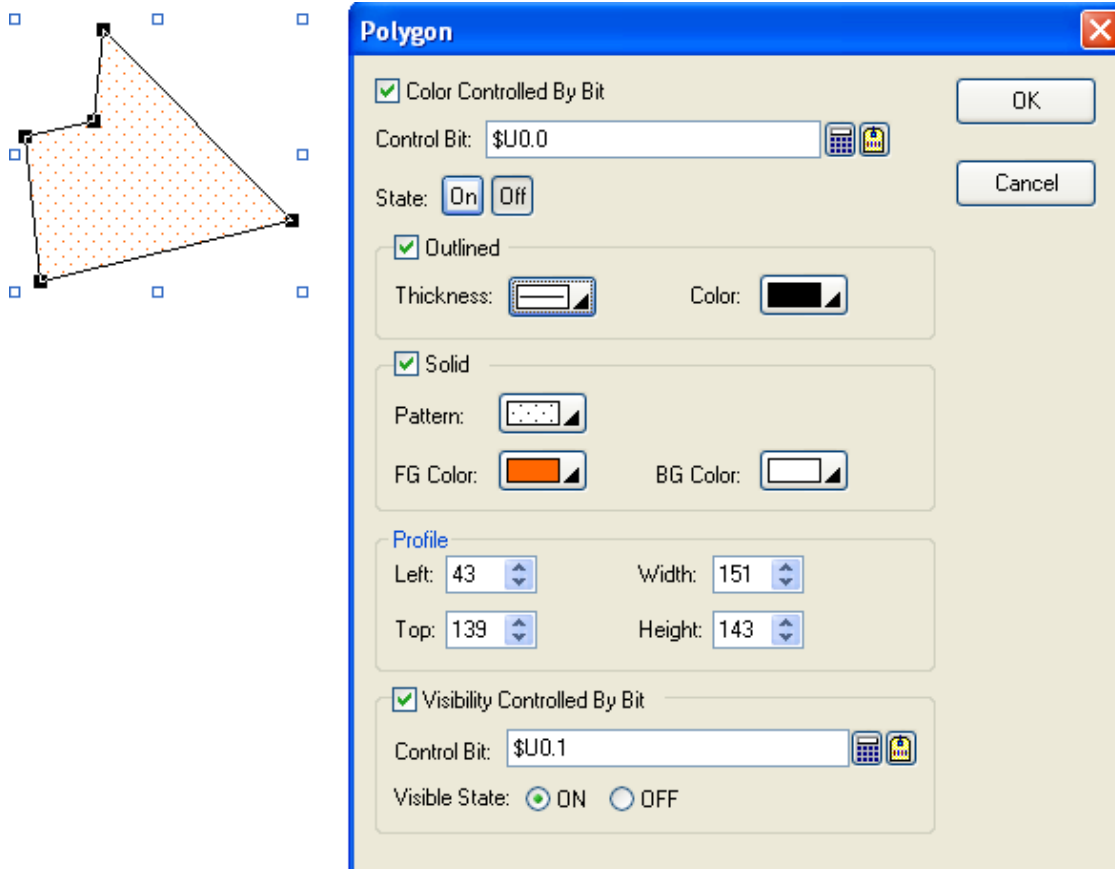



The following table describes each property in the Polygon dialog box.





Property		Description
Color Control	Color Controlled By Bit	Check this option if the color of the polygon will be controlled by the specified bit.
	Control Bit	Specifies the bit that controls the color. Click  to enter the bit address. Click  to enter the bit tag.
	State	Select the state that you want to view or define the colors for.
Outline	Outlined	Check this option if you want the polygon to be outlined.
	Thickness	Specifies the thickness of the outline.
	Color	Specifies the outline color for the selected state.
Solid	Solid	Check this option if you want the polygon to be solid. A solid polygon is filled with the specified pattern and colors.
	Pattern	Specifies the fill pattern for the selected state.
	FG Color	Specifies the color for the selected state that will be used for painting the black part of the fill pattern.
	BG Color	Specifies the color for the selected state that will be used for painting the white part of the fill pattern.

Continued



Property		Description
Profile	Left	The X coordinate of the upper-left corner of the bounding rectangle of the polygon.
	Top	The Y coordinate of the upper-left corner of the bounding rectangle of the polygon.
	Width	The width of the bounding rectangle of the polygon.
	Height	The height of the bounding rectangle of the polygon.
Visibility Control	Visibility Controlled By Bit	Check this option if the polygon will be shown or hidden by the specified bit.
	Control Bit	Specifies the bit that shows or hides the polygon. Click  to enter the bit address. Click  to enter the bit tag.
	Visible State	Specifies the state (On or Off) that makes the polygon visible.

9. You can click the following icons in the Draw toolbar to modify the properties of the polygon.

Click Icon	To
	Select a line style for the border.
	Select a color for the border.
	Select a color for painting the white part of the fill pattern.
	Select a pattern for the fill pattern.
	Select a color for painting the black part of the fill pattern.



### 4.1.10. Drawing Text Objects

1. In the Draw menu or Draw toolbar, click **Text** .
2. Move the cursor onto the screen where you want to draw a text object. A text object with default settings will display and move along with the cursor.
3. Click the desired position on the screen to place the text object. The upper-left corner of the bounding box of the text object will be at the clicked position.
4. Double-click the text object to bring up the Text Object dialog box and then modify the settings of the text object. This dialog box contains the following three pages:
  - **General**  
Described in [Section 4.1.10.1](#).
  - **Shape**  
Described in [Section 4.3.4](#)
  - **Visibility**  
Described in [Section 4.4.6](#).

**Note 1:** You can use the Text toolbar to modify the properties of the text object's text instantly.

**Note 2:** You can use the Draw toolbar to modify the properties of the text object's shape instantly.

**Tip:** By default, the Auto Text Resizing on the Edit menu is checked and the related icon on the Edit toolbar is sunken. If you don't want to resize the text when resizing the object, you need to uncheck the Auto Text Resizing command on the Edit menu or click the sunken icon  on the Edit toolbar to make the font size fixed.

#### 4.1.10.1. General Settings

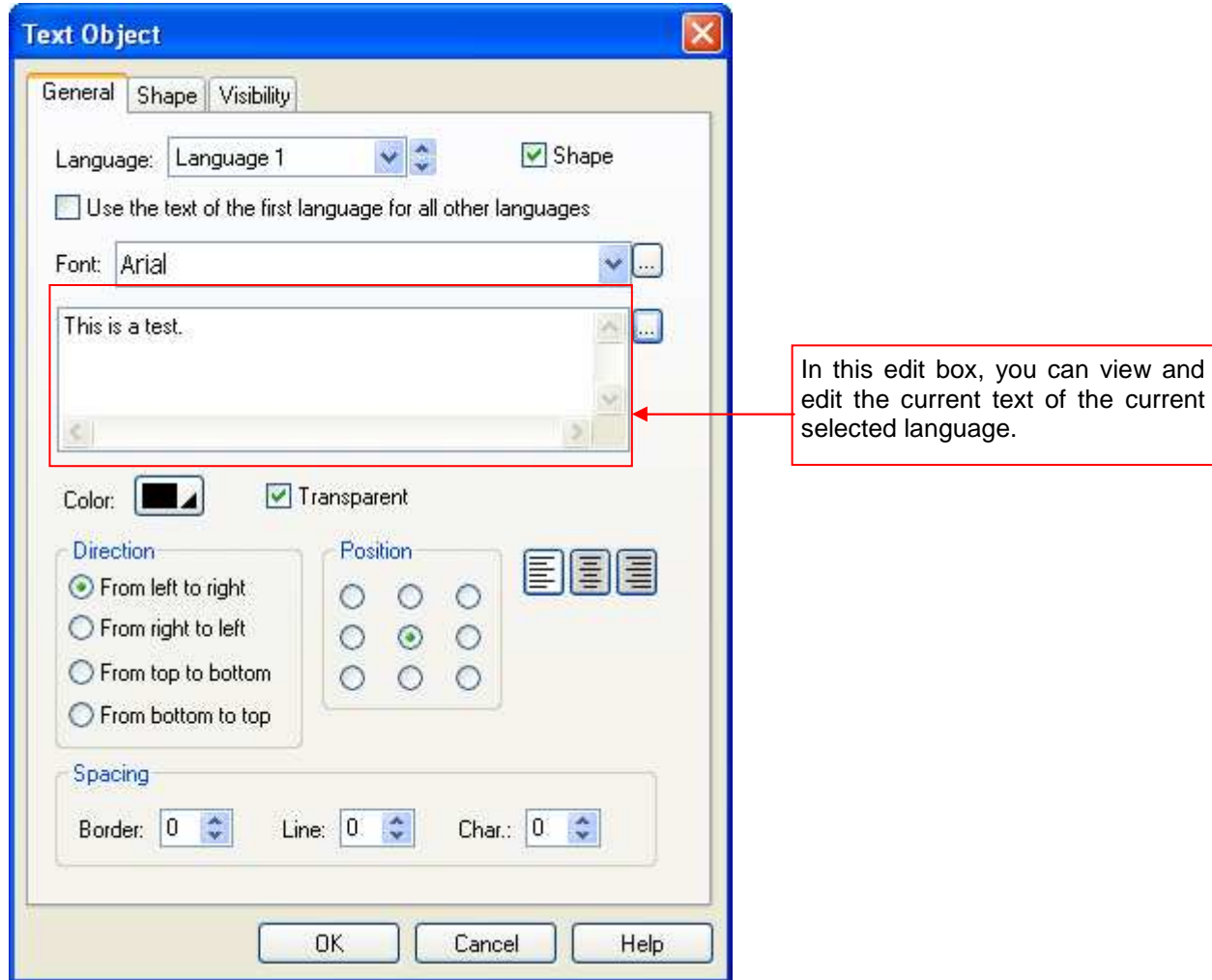

This section describes how to define the general settings for text objects.



The above is an example of the General page of the Text Object dialog box.

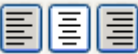

The following table describes each property in the General page.

Property	Description										
Language	The language that you are setting the text for.										
Shape	Check this option if you want the text object to have a frame as its background. The Shape page appears in the dialog box when the option is selected.										
Use the text of the first language for all other languages	Check this item so the text object always shows the text of the first language regardless of what the current language is.										
Font	The font of the current text. You can use the drop-down list to select a font. Or click  to bring up the Font Templates dialog box and select a font for the current text. You can change the font templates before selecting a font in that dialog box.										
<Text Edit Box>	The current text of the current selected language. You can view and edit the text for the selected language in this edit box. Or click  to bring up the Text Source dialog box to select a text from Text Database. You can change the text database before selecting a text in that dialog box.										
Color	The color of the text. To specify the color, click the corresponding Color icon and select a color from the Color palette.										
Transparent	Check this item to make the background of the text transparent.										
BG Color	Specifies the background color of the text. This field is available when the Transparent is not selected.										
Direction	Select one of the following directions to arrange the characters of the text. <table border="1" data-bbox="363 965 1497 1451"> <thead> <tr> <th>Direction</th> <th>From left to right</th> <th>From right to left</th> <th>From top to bottom</th> <th>From bottom to top</th> </tr> </thead> <tbody> <tr> <td>Input text: An example</td> <td>An example</td> <td>elpmaxe nA</td> <td>A n  e x a m p l e</td> <td>e l p m a x e  n A</td> </tr> </tbody> </table>	Direction	From left to right	From right to left	From top to bottom	From bottom to top	Input text: An example	An example	elpmaxe nA	A n  e x a m p l e	e l p m a x e  n A
Direction	From left to right	From right to left	From top to bottom	From bottom to top							
Input text: An example	An example	elpmaxe nA	A n  e x a m p l e	e l p m a x e  n A							
Position 	The position of the text body.										
	The alignment of the text.										
Border Spacing	The margin (in pixels) to the border of the object's shape for the text body.										
Line Spacing	The distance (in pixels) between two adjacent lines of the text.										
Character Spacing	The distance (in pixels) between two adjacent characters of the text.										



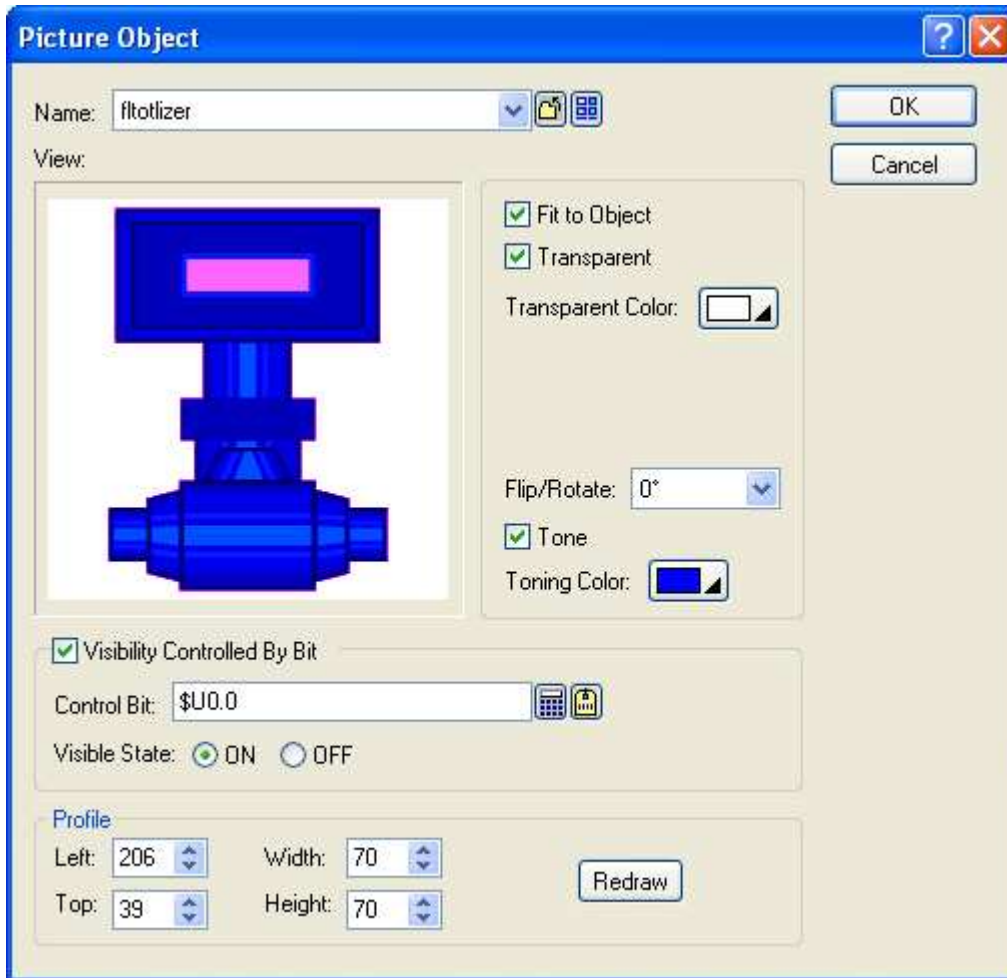

### 4.1.11. Drawing Picture Objects

1. In the Draw menu or Draw toolbar, click **Picture** .
2. Move the cursor onto the screen where you want to draw a picture object. A picture object with default settings will display and move along with the cursor.
3. Click the desired position on the screen to place the picture object. The upper-left corner of the bounding box of the picture object will be at the clicked position.
4. Double-click the picture object to bring up the Picture Object dialog box. Select a picture and define the settings for the picture object in the dialog box. Note that you can use the Picture toolbar to modify the properties of the picture object instantly. The following is an example of the Picture Object dialog box.





The following table describes each property in the Picture Object dialog box.

Property	Description
Name	<p>The name of the picture that the object displays. You can use the drop-down list to select a picture from the picture database.</p> <p>Click  to select a picture from a file. After the selection, PM Designer imports the picture of the selected file and saves the picture in the picture database.</p> <p>Click  to bring up the Select/Import from Library dialog box. Select a picture from a picture library file. After the selection, PM Designer imports the selected picture from the selected library and saves the picture in the picture database.</p>
View	Shows the processed result of the selected picture according to the current settings.
Fit to Object	Check this item so the picture can change its size automatically to just fit inside the object.

Continued



Property		Description																		
Transparent		Check this item to make parts of the picture transparent. The transparent parts are pixels whose colors are identical to the specified transparent color. This item is available when the picture is not a black and white picture.																		
Transparent Color		The transparent color. This item is available when the picture is not a black and white picture.																		
FG Color		The color to paint the black part of a black and white picture. This item is available when the picture is a black and white picture.																		
BG Color		The color to paint the white part of a black and white picture. This item is available when the picture is a black and white picture.																		
Flip/Rotate		Specifies the method to flip or rotate the picture before drawing it. There are 8 options: <table border="1" data-bbox="598 672 1497 1115"> <thead> <tr> <th>Method</th> <th>Description</th> </tr> </thead> <tbody> <tr> <td>0°</td> <td>Do nothing</td> </tr> <tr> <td>90°</td> <td>Rotates the picture clockwise by 90 degree</td> </tr> <tr> <td>180°</td> <td>Rotates the picture clockwise by 180 degree</td> </tr> <tr> <td>270°</td> <td>Rotates the picture clockwise by 270 degree</td> </tr> <tr> <td>X</td> <td>Flips the picture over X axis</td> </tr> <tr> <td>90° &amp; X</td> <td>Rotates the picture clockwise by 90 degree and flips it over X Axis</td> </tr> <tr> <td>Y</td> <td>Flips the picture over Y axis</td> </tr> <tr> <td>90° &amp; Y</td> <td>Rotates the picture clockwise by 90 degree and flips it over Y Axis</td> </tr> </tbody> </table>	Method	Description	0°	Do nothing	90°	Rotates the picture clockwise by 90 degree	180°	Rotates the picture clockwise by 180 degree	270°	Rotates the picture clockwise by 270 degree	X	Flips the picture over X axis	90° & X	Rotates the picture clockwise by 90 degree and flips it over X Axis	Y	Flips the picture over Y axis	90° & Y	Rotates the picture clockwise by 90 degree and flips it over Y Axis
Method	Description																			
0°	Do nothing																			
90°	Rotates the picture clockwise by 90 degree																			
180°	Rotates the picture clockwise by 180 degree																			
270°	Rotates the picture clockwise by 270 degree																			
X	Flips the picture over X axis																			
90° & X	Rotates the picture clockwise by 90 degree and flips it over X Axis																			
Y	Flips the picture over Y axis																			
90° & Y	Rotates the picture clockwise by 90 degree and flips it over Y Axis																			
Tone		Check this item to tone the picture.																		
Toning Color		The color to tone the picture.																		
Visibility Control	Visibility Controlled By Bit	Check this option if the picture will be shown or hidden by the specified bit.																		
	Control Bit	Specifies the bit that shows or hides the picture object. Click  to enter the bit address. Click  to enter the bit tag.																		
	Visible State	Specifies the state (On or Off) that makes the picture visible.																		
Profile	Left	The X coordinate of the upper-left corner of the object.																		
	Top	The Y coordinate of the upper-left corner of the object.																		
	Width	The width of the object.																		
	Height	The height of the object.																		
	Redraw	Click this button to redraw the object on the screen with the current settings.																		

### 4.1.12. Drawing Scales

1. In the Draw menu or Draw toolbar, click **Scale** .
2. Move the cursor onto the screen where you want to draw a scale. A scale with default settings will display and move along with the cursor.
3. Click the desired position on the screen to place the scale. The upper-left corner of the bounding box of the scale will be at the clicked position.
4. Double-click the scale to bring up the Scale dialog box and then define the settings for the scale. The following is an example of the Scale dialog box. To the right of the dialog box shows the corresponding scale.

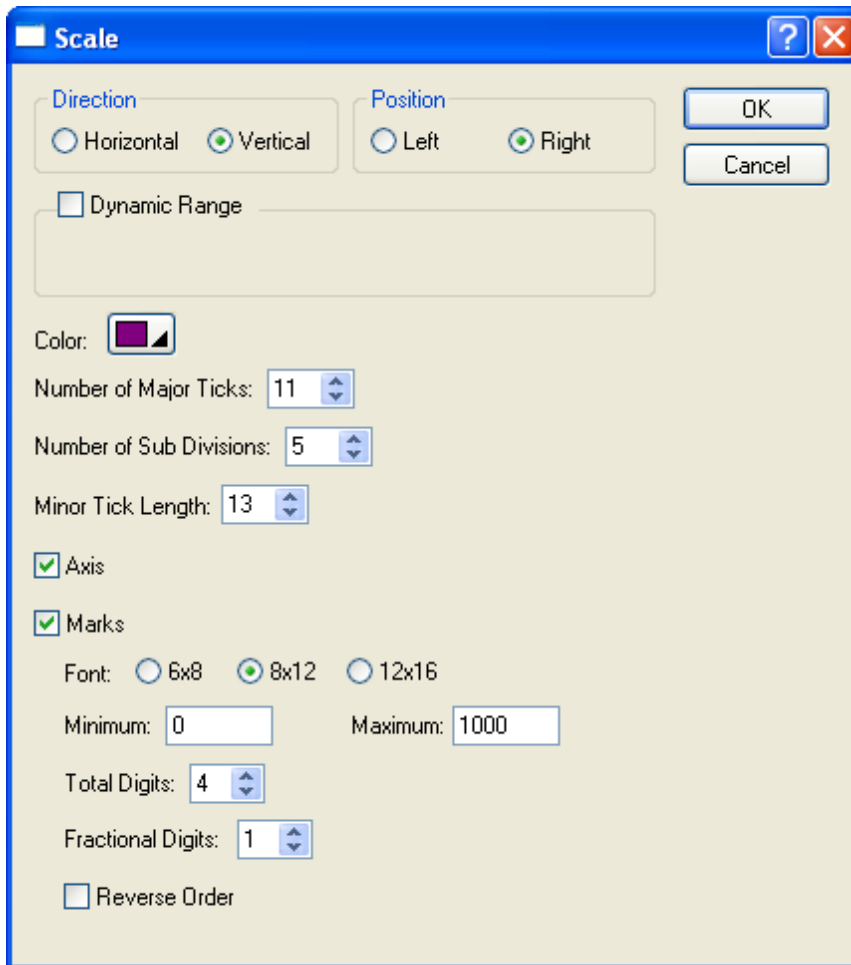





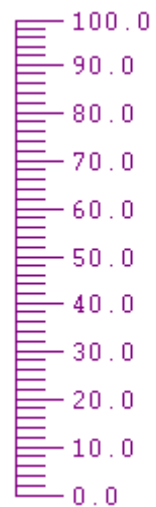



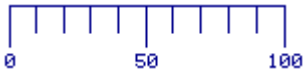

The Scale dialog box is a window with a blue title bar and standard Windows window controls. It contains the following settings:

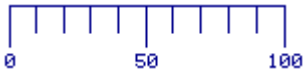
- Direction:** Radio buttons for Horizontal and Vertical. Vertical is selected.
- Position:** Radio buttons for Left and Right. Right is selected.
- Dynamic Range:** An unchecked checkbox.
- Color:** A color selection box showing a purple color.
- Number of Major Ticks:** A spin box set to 11.
- Number of Sub Divisions:** A spin box set to 5.
- Minor Tick Length:** A spin box set to 13.
- Axis:** A checked checkbox.
- Marks:** A checked checkbox.
- Font:** Radio buttons for 6x8, 8x12, and 12x16. 8x12 is selected.
- Minimum:** A text box containing the value 0.
- Maximum:** A text box containing the value 1000.
- Total Digits:** A spin box set to 4.
- Fractional Digits:** A spin box set to 1.
- Reverse Order:** An unchecked checkbox.

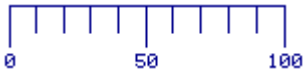

The following table describes each property in the Scale dialog box.

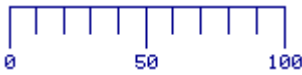
Property		Description															
Direction and Position		<p>Select the direction and the position for the scale according to the following table.</p> <table border="1"> <thead> <tr> <th>Direction</th> <th colspan="2">Horizontal</th> <th colspan="2">Vertical</th> </tr> <tr> <th>Position</th> <th>Top</th> <th>Bottom</th> <th>Left</th> <th>Right</th> </tr> </thead> <tbody> <tr> <td>Example</td> <td></td> <td></td> <td></td> <td></td> </tr> </tbody> </table>	Direction	Horizontal		Vertical		Position	Top	Bottom	Left	Right	Example				
Direction	Horizontal		Vertical														
Position	Top	Bottom	Left	Right													
Example																	
Dynamic Range	Dynamic Range	Check this item if you want the numbers of the scale ticks and the range of the scale marks to be dynamic, i.e. to be controlled by the specified variable.															
	Parameter Block	<p>Specifies the variable that controls the numbers of the scale ticks and the range of the scale marks. The variable is an array of four double-words (8 words). The following table describes the data members of the array.</p> <table border="1"> <thead> <tr> <th>Word #</th> <th>Data Type</th> <th>Description</th> </tr> </thead> <tbody> <tr> <td>0, 1</td> <td>32-bit unsigned integer</td> <td>The number of major ticks. The allowable range of this number is between 2 and 101.</td> </tr> <tr> <td>2, 3</td> <td>32-bit unsigned integer</td> <td>The number of divisions between two adjacent major ticks. The allowable range of this number is between 1 and 100.</td> </tr> <tr> <td>4, 5</td> <td>32-bit signed integer</td> <td>The minimum of the scale marks.</td> </tr> <tr> <td>6, 7</td> <td>32-bit signed integer</td> <td>The maximum of the scale marks.</td> </tr> </tbody> </table> <p><b>Example</b> Assume a scale's dynamic range control block is \$U100. The following macro commands makes that scale look like this:</p>  <pre> \$U100 = 3 (UD) // The number of major ticks. \$U102 = 5 (UD) // The number of sub-divisions. \$U104 = 0 (SD) // The minimum of the scale marks. \$U106 = 100 (SD) // The maximum of the scale marks.                     </pre>	Word #	Data Type	Description	0, 1	32-bit unsigned integer	The number of major ticks. The allowable range of this number is between 2 and 101.	2, 3	32-bit unsigned integer	The number of divisions between two adjacent major ticks. The allowable range of this number is between 1 and 100.	4, 5	32-bit signed integer	The minimum of the scale marks.	6, 7	32-bit signed integer	The maximum of the scale marks.
Word #	Data Type	Description															
0, 1	32-bit unsigned integer	The number of major ticks. The allowable range of this number is between 2 and 101.															
2, 3	32-bit unsigned integer	The number of divisions between two adjacent major ticks. The allowable range of this number is between 1 and 100.															
4, 5	32-bit signed integer	The minimum of the scale marks.															
6, 7	32-bit signed integer	The maximum of the scale marks.															
Color		The color of the scale. To specify the color, click the corresponding Color icon and select a color from the Color palette.															
Number of Major Ticks		The number of major ticks. The minimum you can specify is two.															
Number of Sub Divisions		The number of divisions between two adjacent major ticks. The minimum you can specify is one.															
Minor Tick Length		The length of minor ticks.															
Axis		Check this item if you want the scale to have an axis.															
Marks	Marks	Check this option if you want the scale to have marks.															
	Font	The font of the marks.															
	Minimum	The minimum of the marks. It is a 32-bit integer.															
	Maximum	The maximum of the marks. It is a 32-bit integer.															
	Total Digits	The total digits to be displayed for the marks.															
	Fractional Digits	The number of fractional digits for the marks. For example, when the Maximum is 5000, the Total Digits is 4, and the Fractional Digits is 2, the mark for the Maximum will be 50.00.															
	Reverse Order	Check this option if you want the marks of the scale to show in reverse order. In normal order, the maximal mark is at the right end or top end of the scale. In reverse order, the maximal mark is at the left end or bottom end of the scale.															

### 4.1.13. Drawing Tables

1. In the Draw menu or Draw toolbar, click **Table** .
2. Move the cursor onto the screen where you want to draw a table. A table with default settings will display and move along with the cursor.
3. Click the desired position on the screen to place the table. The upper-left corner of the table will be at the clicked position.
4. Use drag-and-drop editing to move an existing object into an empty cell of the table. If the object is allowed to be placed in the cell, a message box will pop up to confirm the operation. The following is an example of object insertion with confirmation dialog box.

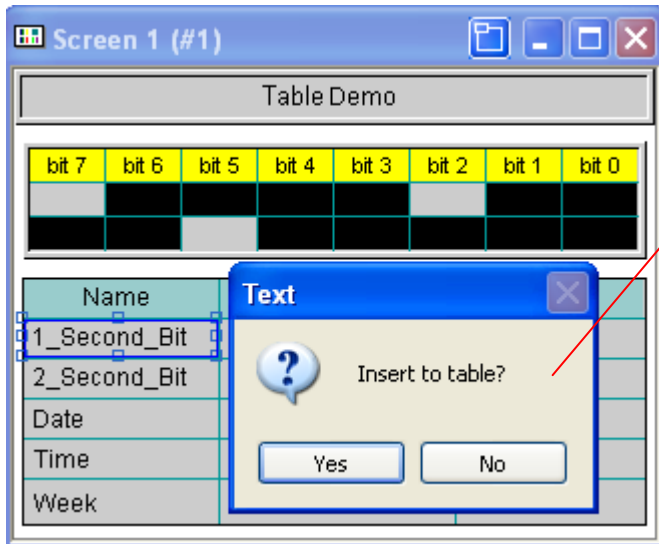



- If you click Yes to insert the object to the table, the object will be part of the table. Any modifications such as moving the table, resizing the table, deleting the table... will be applied to the objects of the table at the same time.
- If you click No to cancel the operation, the object will move to the specified position and float over the table.

**Note:** Only 23 types of the objects can be placed in the cells of the table. The supported objects are Picture, Dot, Text, Bit Button, Toggle Switch, Word Button, Multistate Switch, Screen Button, Function Button, Keypad Button, Numeric Display, Numeric Entry, ASCII String Display, ASCII String Entry, Bit Lamp, Multistate Lamp, Time Display, Date Display, Day-of-Week Display, Message Display, Bar Graph, Picture Display, GIF Display, Advanced Numeric Display.

5. Click the cell inside the table. If the cell contains the object, there will be the  icon on the upper-left corner of the cell. The following is an example shown you how to edit the object in the table.

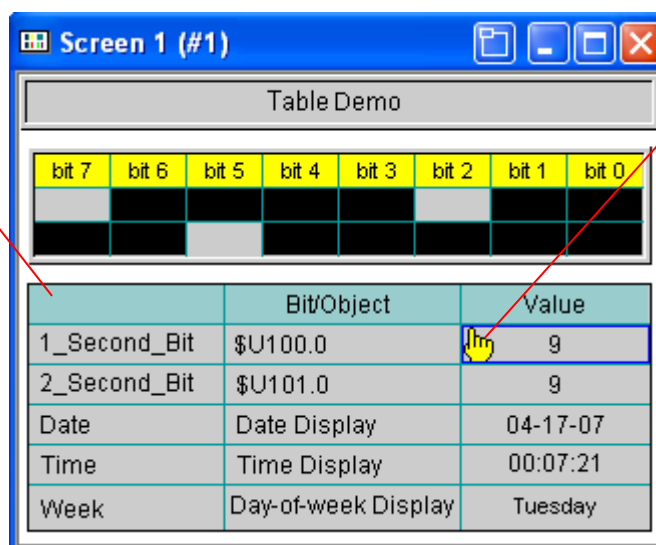

This is an empty cell where you can place an object.



➤ Left-click the icon and hold down the button. When the cursor turns to be , move the object out of the table.

➤ Double click the icon to bring up the properties dialog box of the corresponding object and then define the settings of object for the selected cell.



6. Position the mouse point over one of the grid lines. When the cursor turns to be  or , drag the line until the column is the width and the row is the height you want.

Name	Bit/Object	Value
1_Second_Bit	\$U100.0	9
2_Second_Bit	\$U101.0	9
Date	Date Display	04-17-07
Time	Time Display	00:07:21
Week	Day-of-week Display	Tuesday

Drag the line to adjust the width of the column.

Drag the line to adjust the height of the row.

**Note:** You can adjust the width of the column when the Distribute columns evenly is not selected in the general page of the Table dialog box. And you can adjust the height of the row when the Distribute rows evenly is not selected in the general page of the Table dialog box.

7. Double-click anywhere inside the table, exclusive of the  icon, to bring up the Table dialog box and then define the settings for the table. This dialog box contains the following two pages:
- **General**  
Described in [Section 4.1.13.1](#).
  - **Cell**  
Described in [Section 4.1.13.2](#).

### 4.1.13.1. General Settings

This section describes how to define the general settings for table objects. The following is an example of the General page of the Table Object dialog box.

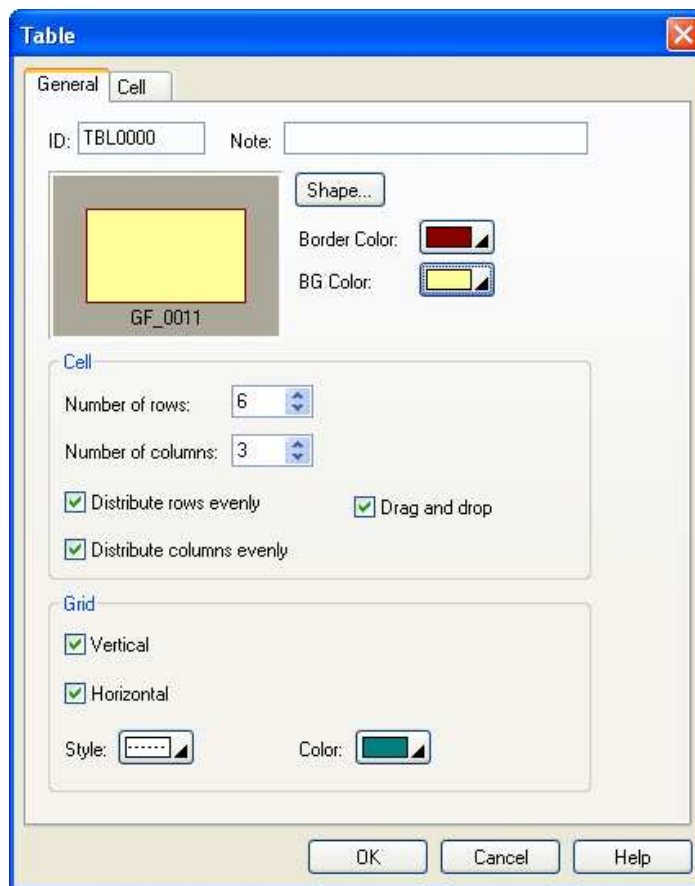

The following table describes each property in the General page of the Table dialog box.

Property		Description
ID		The object's identifier. It is generated when the object is created and is unchangeable. The identifier is unique within the screen where the object is on. The format of the ID's for the tables is TBLnnnn.
Note		You can type a note for the object.
Shape settings		For details about the following properties, see <a href="#">Section 4.3.4 Setting up the Shape of an Object</a> .  , Border Color, BG Color
Cell	Number of rows	Specifies the number of rows in the table.
	Number of columns	Specifies the number of columns in the table.
	Distribute rows evenly	Check this option if you want the rows of the table to be distributed evenly always. Uncheck this option if you want to adjust the heights of the rows.
	Distribute columns evenly	Check this option if you want the columns of the table to be distributed evenly always. Uncheck this option if you want to adjust the widths of the columns.
	Drag and drop	Check this option so you can drag and drop an object into a cell of the table. Note that not all kinds of objects can be placed in the cells of the table.
Grid	Vertical	Check this option if you want the table to have vertical grid lines.
	Horizontal	Check this option if you want the table to have horizontal grid lines.
	Style	Specifies the style for the grid lines.
	Color	Specifies the color for the grid lines.



#### 4.1.13.2. Cell Settings

The following is an example of the Cell page of the Table Object dialog box and Select Object Dialog box when the Insert Button is clicked.

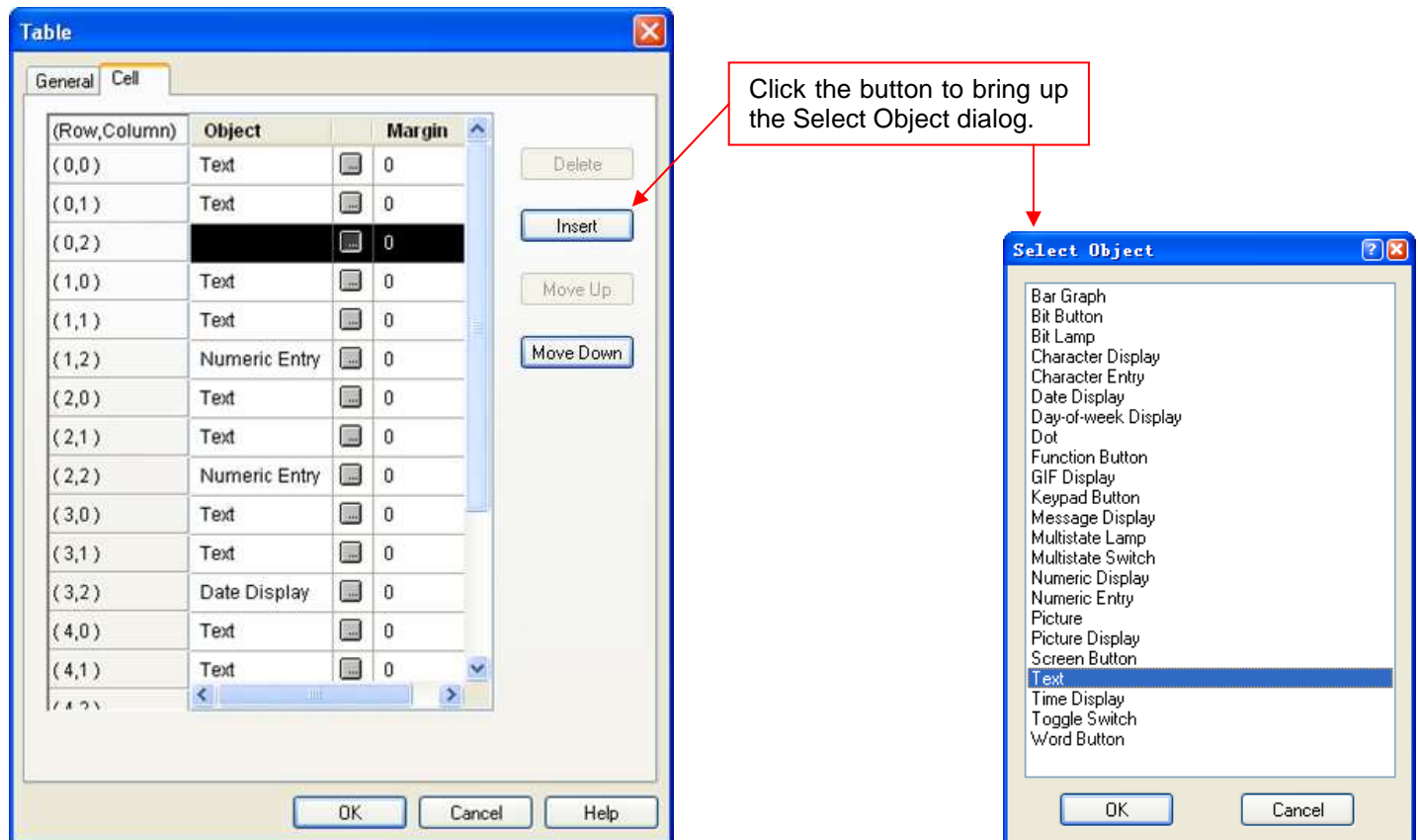

The following table describes each property in the Cell page of the Table dialog box. To make the buttons available, you need to select a row. To select a row, left-click the (Row, Column) column.

Property	Description
(Row,Column)	The location of the cell.
Object	The type of the specified object. If the field is empty, the cell has no object inserted and it is called empty cell.
	Click the button to bring up the properties dialog box of the specified object and define the settings of the object for the selected cell. The button is available when the Object field is not empty.
Margin	The distance in pixels between the object boundary and the cell border. Select a number between 0 and 10.
Delete	Click the button to clear the contents of the selected cell. The button is available when the selected cell is non-empty.
Insert	Click the button to bring up the Select Object Dialog Box shown above. And select an object type listing in the dialog to create a new object for the selected cell. The button is available when the selected cell is empty.  <b>Note:</b> The table won't allow to insert the type of an object which is not listed in the dialog.
Move Up	Click the button to move the selected cell before the previous cell. It will not be available when multiple rows are selected or no row is selected or the first row is selected.
Move Down	Click the button to move the selected cell after the next cell. It will not be available when multiple rows are selected or no row is selected or the last row is selected.



## 4.2. Editing Objects

In this section you will learn how to select the objects first and then move around, copy, or edit the selections without affecting the rest of the screen.

### 4.2.1. Selecting and De-selecting the Objects

#### ■ Selecting Objects

To select an object, move the mouse to the object you want to select and then click the left button.

To add an object to the selection, use Shift + Click.

To select all objects of the active screen, use Ctrl + A or use the Select All command on the Edit menu.

#### ■ Selecting Objects by a Rectangular Area

Click the mouse left button on the blank area of the screen, and hold the button to begin your selection. Where you click will become one of the corners of the rectangular selection area. Then drag the mouse diagonally. Release the mouse button when to the position you want the opposite corner of the rectangular area to be.

Each of the selected objects will have blue square-shaped tabs around it. The object with solid tabs is the reference object.

#### ■ De-selecting the Objects

To de-select the objects, either click the blank area of the screen, or make a new selection.

### 4.2.2. Basic Operations with the Selected Area

#### ■ Moving Objects





Left-click anywhere inside the selected objects and hold down the button. When the cursor turns to be , drag the mouse to move the selection to another area of the screen. It will "float" over the rest of the screen, allowing you to position it wherever you want it to be. Release the mouse button to "let go" of the selection.

#### ■ Grouping or Ungrouping Objects

To group the selection, click  on the edit toolbar, or use the Group command on the Edit menu or on the object popup menu. After you have grouped a selection that includes at least two objects, you can copy, move and resize all objects in a group as a single unit. Or you can select an object within the group and change the properties without ungrouping. You can also save the group to the object library and use this object group in the animated graphic.

To ungroup the selected group, click  on the edit toolbar, or use the Ungroup command on the Edit menu or on the object popup menu. After ungrouping the objects, the objects within the group will be restored to the single ones.

#### ■ Resizing Objects

The square-shaped tabs around your object can be re-sized. You can resize by clicking on the square-shaped tabs located at the corners and the middle sections of the bound rectangle area, holding the mouse button down, when the cursor turns to be  or  or  or , dragging the mouse to change the size of the selection. Release the mouse button when the selection is the size you want it to be. You can make it bigger or smaller, and achieve a distorted effect by "squashing" or "stretching" the selection to make it either wider/narrower or taller/shorter than its original proportions.

**Tip:** You can't resize more than one object at a time unless you group multiple objects before resizing.

#### ■ Auto Text Resizing

To automatically scale the text of the object when resizing the object, click  on the edit toolbar if it is raised, or use the Auto Text Resizing command on the Edit menu.

**Tip:** Auto Text Resizing command is checked and the icon is sunken by default. If you don't want to resize the text when resizing the object, you need to uncheck the Auto Text Resizing command or click the sunken icon to make the font size fixed.



### ■ Pinning or Unpinning Objects

To pin the selection so it can not move, click  on the edit toolbar, or use the Pin command on the Edit menu or on the object popup menu.

To unpin the selection so it can move again, click  on the edit toolbar, or use the Unpin command on the Edit menu or on the object popup menu.

**Tip:** Pinning objects can still be resized.

### ■ Copying or Cutting and Pasting Objects

To copy the selection from the current screen and places it on the Windows™ clipboard, press Ctrl+C, or click  on the standard toolbar, or use the Copy command on the Edit menu or on the object popup menu.

To cut the selection from the screen, press Ctrl+X, or click  on the standard toolbar, or use the Cut command on the Edit menu or on the object popup menu.

After Copying or Cutting, you can paste the selection by pressing Ctrl+V, or click  on the standard toolbar, or use the Paste command on the Edit menu or on the object popup menu.

To copy and paste the selection by mouse, press and hold down Ctrl key, and then left-click the selection and hold down the button. When the cursor turns to be , drag the mouse to copy the selection to another area of the screen. The picture on the right shows the example.

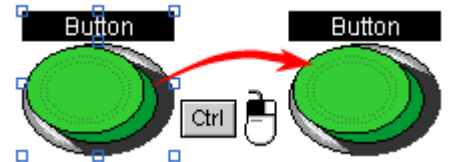

**Tip:** Cut and Paste are good for moving objects around in the screen or to another screen.

Copy and Paste are good for duplication objects for current screen or some others screens.

By pasting multiple times on the current screen, you can achieve a cascading effect.

By pasting once to the different screen, the position of the pasted object will be same as the copied object in the different screen.

### ■ Deleting Objects

To delete the selection, press Del or use the Delete command on the Edit menu or on the object popup menu. When you use Delete, whatever is in the selection will be deleted.

### ■ Undo

To reserve the last action, press Ctrl+Z, or use the Undo command on the Edit menu.

### ■ Redo

To reapply the actions that were previously canceled by the Undo command. press Ctrl+Z, or use the Redo command on the Edit menu.

### ■ Keyboard Shortcuts

Shortcut	Operation	Shortcut	Operation	Shortcut	Operation
【Ctrl+N】	New Project	【Ctrl+X】	Cut	【Ctrl+D】	Duplicate
【Ctrl+O】	Open Project	【Ctrl+C】	Copy	【Ctrl+F】	Find
【Ctrl+S】	Save	【Ctrl+V】	Paste	【Ctrl+R】	Replace
【Ctrl+Z】	Undo	【Ctrl+Click+move】	Copy & Paste	【Ctrl+A】	Select All
【Ctrl+Y】	Redo	【Del】	Delete	【Shift+Click】	Multiple Select
				【Ctrl+Click】	Reference Object Select

### 4.2.3. Duplicating Objects

To duplicate the selected object, use the Duplicate... command on the Edit menu or on the object popup menu. After the duplicate command is executed, the following dialog will popup and allows you to set how to duplication objects.

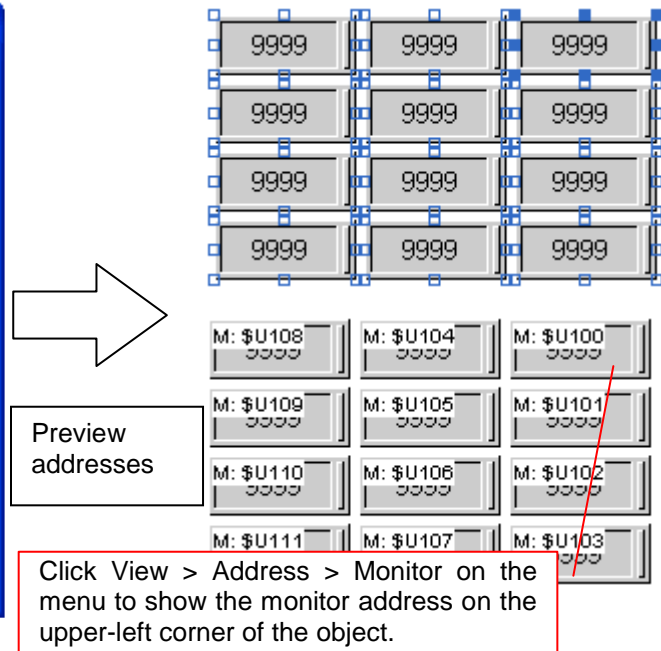
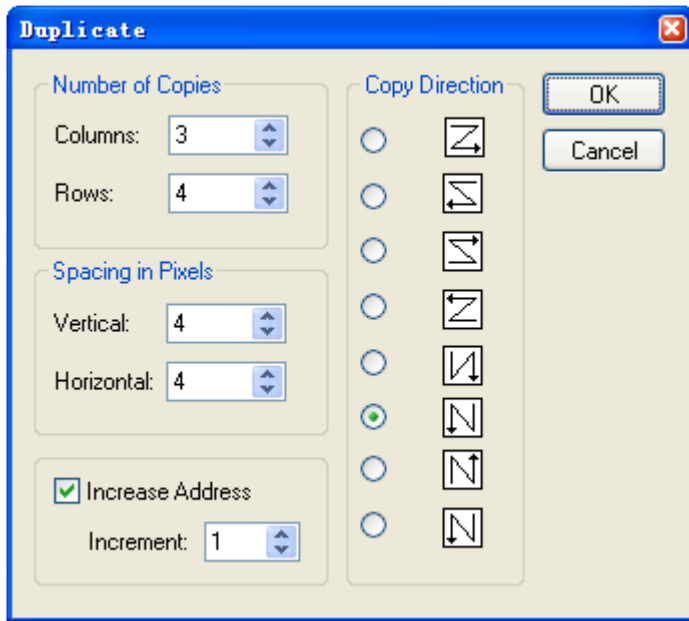

The following table describes each property in the Duplicate dialog.

Property		Description
Number of Copies	Columns	The total number of the columns.
	Rows	The total number of the rows.
Spacing in Pixels	Vertical	The distance (in pixels) between two adjacent objects in the vertical direction.
	Horizontal	The distance (in pixels) between two adjacent objects in the horizontal direction.
Increase Address		Check this item so the address of each duplicate will be increased of the specified increment over the previous object.
Increment		The increase amount.
Copy Direction		From top to down, place the duplicates row by row. In the same row, place the duplicate to the right of the previous object.
		From top to down, place the duplicates row by row. In the same row, place the duplicate to the left of the previous object.
		From down to top, place the duplicates row by row. In the same row, place the duplicate to the right of the previous object.
		From down to top, place the duplicates row by row. In the same row, place the duplicate to the left of the previous object.
		From left to right, place the duplicates column by column. In the same column, place the duplicate down to the previous object.
		From right to left, place the duplicates column by column. In the same column, place the duplicate down to the previous object.
		From left to right, place the duplicates column by column. In the same column, place the duplicate up to the previous object.
		From right to left, place the duplicates column by column. In the same column, place the duplicate up to the previous object.



#### 4.2.4. Aligning Objects

To arrange the selected objects on a screen, you need to select a reference object from the selections and then press the icon on the toolbar or click the menu item listed as below. To do the multiple selection, use Shift + Click. To select a reference object from the selections, use Ctrl + Click.



Use the **Align** commands on the [Edit](#) menu to arrange objects/draws on a screen. Select an object or draw by single-clicking on it, then hold down the **Shift** key while clicking on other objects or draws to be aligned with it. When all of the objects or draws to be aligned are selected, choose one of the commands in the **Align** submenu or directly click specified icon in the **Edit Toolbar**.

Icon	Menu Item	Description	
	Align	Left	Align the left sides of selected objects to the left side of the reference object. All the objects move horizontally so their left sides are in line with the left side of the reference object.
		Vertical Center	Align the vertical centers of selected objects to the vertical center of the reference object. All the objects move horizontally so their vertical centers are in line with the vertical center of the reference object.
		Right	Align the right sides of selected objects to the right side of the reference object. All the objects move horizontally so their right sides are in line with the right side of the reference object.
		Top	Align the tops of the selected objects to the top of the reference object. All the objects move vertically so their tops are in line with the top of the reference object.
		Horizontal Center	Align the horizontal centers of selected objects to the horizontal center of the reference object. All the objects move vertically so their horizontal centers are in line with the horizontal center of the reference object.
		Bottom	Align the bottoms of selected objects to the bottom of the reference object. All the objects move vertically so their bottoms are in line with the bottom of the reference object.
		To Grid	Select or deselect the option of aligning objects to the grid points.
	Nudge	Left	Nudge the selection left. When the Snap to Grid option is not selected, all objects of the selection move one pixel left. When the Snap to Grid option is selected, each object of the selection moves left to where its upper-left corner aligns to the nearest grid point.
		Right	Nudge the selection right. When the Snap to Grid option is not selected, all objects of the selection move one pixel right. When the Snap to Grid option is selected, each object of the selection moves right to where its upper-left corner aligns to the nearest grid point.
		Up	Nudge the selection up. When the Snap to Grid option is not selected, all objects of the selection move one pixel up. When the Snap to Grid option is selected, each object of the selection moves up to where its upper-left corner aligns to the nearest grid point.
		Down	Nudge the selection down. When the Snap to Grid option is not selected, all objects of the selection move one pixel down. When the Snap to Grid option is selected, each object of the selection moves down to where its upper-left corner aligns to the nearest grid point.







### 4.2.5. Making Objects Same Size

To make the selection same size as the reference object which can be selected by using Ctrl + Click, press the icon on the toolbar or click the menu item listed as below.

Icon	Menu Item	Description	
	Make Same Size	Width	Make the selected objects have the same width as the reference object.
		Height	Make the selected objects have the same height as the reference object.
		Both	Make the selected objects have the same width and height as the reference object.

### 4.2.6. Arranging the Order of Objects

Icon	Menu Item	Description	
	Layer	Bring to Top	Bring the selection to the top.
		Bring Forward	Bring the selected object one layer up.
		Send Backward	Send the selected object one layer down.
		Send to Bottom	Send the selection to the bottom.
	Set Order	Start the order setting process for the objects of the active screen. For details, please see <a href="#">Section 4.2.6.1 Changing the Order of Objects</a>	

#### 4.2.6.1. Changing the Order of Objects

The object order in PM Designer is the order in which the selection cursor moves the input focus from one object to the next within a screen. Usually the order proceeds from left to right and from top to bottom in a screen. In the model with programmable keys such as 037-LSK, the Data Entry Object receives input focus in the specified order by clicking direction keys. In touch panel, you can use function button to select a data entry object with the order number previous or next to the current selection.

The object order is also the display order. If the screen contains overlapping the objects, change the order will change the display sequence of the objects. The objects that come later in the order are always displayed on top of any overlapping objects that precede them in the order.

##### ■ Viewing order

To view the current order of all objects in the screen, click Set Order on the Edit menu.

##### ■ Changing order

To change the order for all objects in the screen

- 1) On the Edit menu, click Set Order  
A Number in the upper-left corner of each object shows its place in the current order
- 2) Set the order by clicking each object in the order you want to display the object. The ordering number starts from 1.
- 3) Click the blank field on the screen to exit Set Order mode

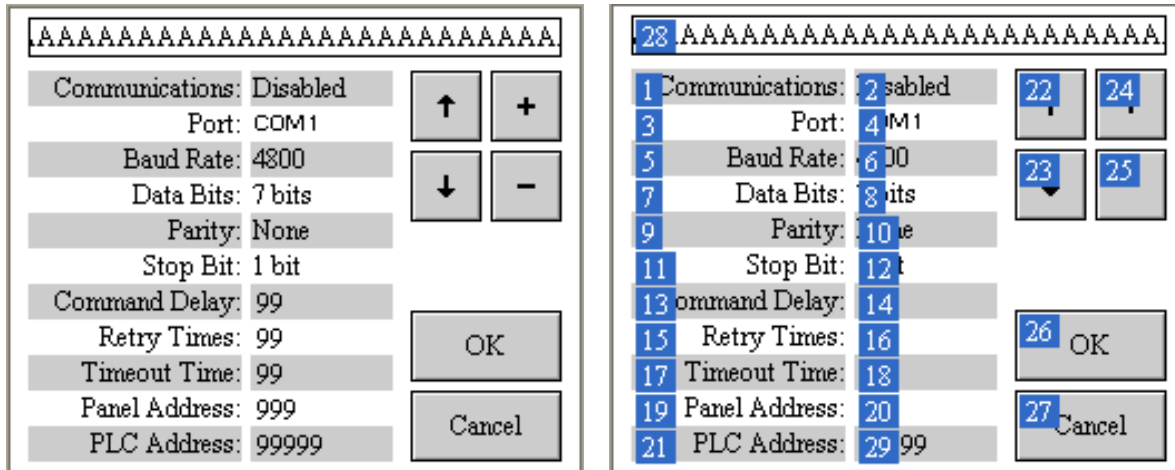

The following is an example of the object ordering.



If the screen running on 037-LSK, click the down or right direction key to move the selection in 2-4-6-8-10-12-14-16-18-20-22-24-26-28 sequence. If the screen running on the touch panel, click function button  to move the selection in the same sequence. The text objects with 1,3,5...order number are not data entry object, so they won't receive the selection and don't list in the sequence.

### 4.3. Designing Object Appearance

There are four common components of object appearance. They are described in the following table:

Appearance Component	Description								
Shape	<p>The shape of an object can either be a graphical shape or a picture shape. The following are examples of graphical shapes</p>  <p>The following are examples of picture shapes.</p>  <p>PM Designer provides many graphical shapes for you to choose. For details, see <a href="#">Section 4.3.3 Selecting a Graphical Shape</a>. The color or the pattern of a graphical shape is dependent on the state of the associated object. You need to specify the color or pattern settings of a graphical shape for each state of the associated object. For details, see <a href="#">Section 4.3.1 Selecting a Color</a> and <a href="#">Section 4.3.2 Selecting a Pattern</a>.</p> <p>If you want an object to have a picture shape, check the item Picture Shape in the General Page of the object's property dialog box. You can select a picture from the picture database or import a picture from a library file for the shape of an object. Any picture with the format of BMP, JPG, or WMF can be a picture shape. When a picture is used as a shape, the shape is state independent, i.e. the same look appears for all (object) states. If you want a picture shape to display the object state and/or show the touch action, you need to select a picture group as the shape. For details of picture groups, see <a href="#">Section 2.1.3.3 Picture Groups</a></p> <p>To know how to set a shape, see <a href="#">Section 4.3.4 Setting up the Shape of an Object</a>.</p>								
Inner Label	<p>An inner label is a label inside the associated object. It has the same number of states as the associated object. You need to specify the text settings and the picture settings of an inner label for each (object) state. Inner labels are language dependent. You need to specify the text of an inner label for each language too. Note that not all objects can have inner labels and some objects can just have text or a picture in their inner label.</p> <p>To know how to set an inner label, see <a href="#">Section 4.3.5 Label Settings</a>.</p>								
VFTA (Visual Feedback for Touch Action)	<p>A button or switch can give the operator one of the following visual feedback when it is touched:</p> <table border="1"> <thead> <tr> <th>Visual Feedback</th> <th>Description</th> </tr> </thead> <tbody> <tr> <td>Sunken</td> <td>Shifts the inner label to the lower-right corner by one or two pixels.</td> </tr> <tr> <td>Back</td> <td>Fills the area inside the border of the shape with the shape's FG Color.</td> </tr> <tr> <td>Outline</td> <td>Outlines the object with the shape's FG Color.</td> </tr> </tbody> </table>	Visual Feedback	Description	Sunken	Shifts the inner label to the lower-right corner by one or two pixels.	Back	Fills the area inside the border of the shape with the shape's FG Color.	Outline	Outlines the object with the shape's FG Color.
Visual Feedback	Description								
Sunken	Shifts the inner label to the lower-right corner by one or two pixels.								
Back	Fills the area inside the border of the shape with the shape's FG Color.								
Outline	Outlines the object with the shape's FG Color.								
External Label	<p>An external label is a label outside but attached to the associated object. Unlike inner labels, external labels are state independent. They have the same look for all (object) states. However, external labels are language dependent. You need to set the text of an external label for each language. External labels are touch insensitive. Touching an external label will not activate the associated object. Note that not all objects can have an external label.</p> <p>To know how to set an external label, see <a href="#">Section 4.3.8 External Label Settings</a>.</p>								











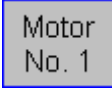

The following table shows the common appearance components that each object type can have:

Object Types	Shape		Inner Label		VFTA	External Label
	Graphical Shape	Picture Shape	Text	Picture		
Bit Button, Toggle Switch, Screen Button, Word Button, Multi-state Switch, Radio Button Group	•	•	•	•	•	•
Function Button, Keypad Button, Page Selector	•	•	•	•	•	
Step Button	•		•	•	•	•
Bit Lamp, Multi-state Lamp,	•	•	•	•		•
Message Display	•		•			•
Picture Display	•			•		•
Day-of-week Display	•		•			
Meter	•	•				
Slide Switch, Numeric Entry, Numeric Display, Advanced Numeric Display, ASCII Character Entry, ASCII Character Display, Bar Graph	•					•
Time Display, Date Display, Pie Graph, Line Chart, Scatter Chart, Alarm Display, Historic Data Display, Historic Trend Graph, Single Record Line Chart, Operation Log Display, Recipe Selector, Recipe Table, Sub-link Table, Static Text, Table	•					
Animated Graphic				•		

The orders of drawing the common appearance components are shown in the following table with examples:

Step	Draw	Example 1	Example 2	Description
1	Shape	 A picture group that supports the pressed look	 A graphical shape named SW_0023	Described in <a href="#">Section 4.3.4</a>
2	Picture of Inner label		(None)	
3	Text of inner label	<b>HELP</b>	<b>START</b>	Described in <a href="#">Section 4.3.5.1</a>
4	VFTA	(None)	Back (FG Color is  )	
5	External label	(None)		Described in <a href="#">Section 4.3.8</a>
Final Appearance (When untouched)				
Final Appearance (When touched)				



### 4.3.1. Selecting a Color

#### ■ Color Icons

In a dialog box, a color icon is associated with a property that requires a color. It shows the color of the current selection and you can click it to bring up the Color palette. With the Color palette, you can select a color for the associated property. The following is a Color icon showing that the current selection is yellow.



#### ■ Color Palette

With the Color palette, you can: 1) Select a color from a set of predefined colors, 2) Customize a set of user colors, and 3) Select a color from a set of user colors.

Usually, you click a Color icon to bring up the Color palette. The following shows the pages of the Color palette.

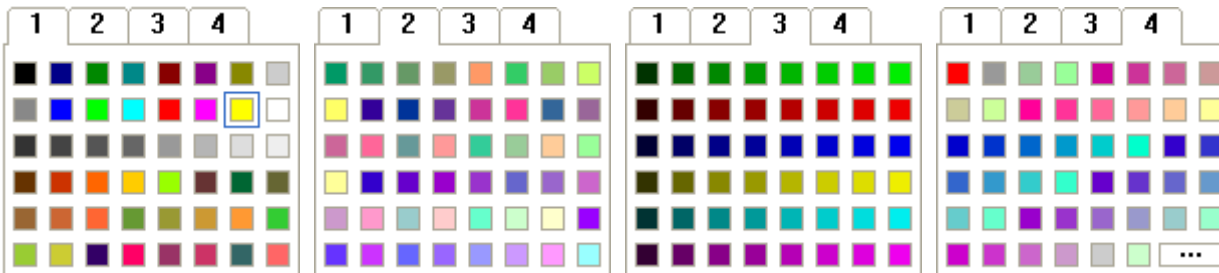

On page 1, the yellow block is outlined to indicate that it is the current selection. To select a color, click on that color block. To select a page, click on that page's number tab. To cancel the operation click on any position other than the color blocks and the number tabs. Page 1, 2, and 3 contain the predefined colors. Page 4 contains the user colors. To customize user colors, click  to bring up the Define Custom Color dialog box as shown below.

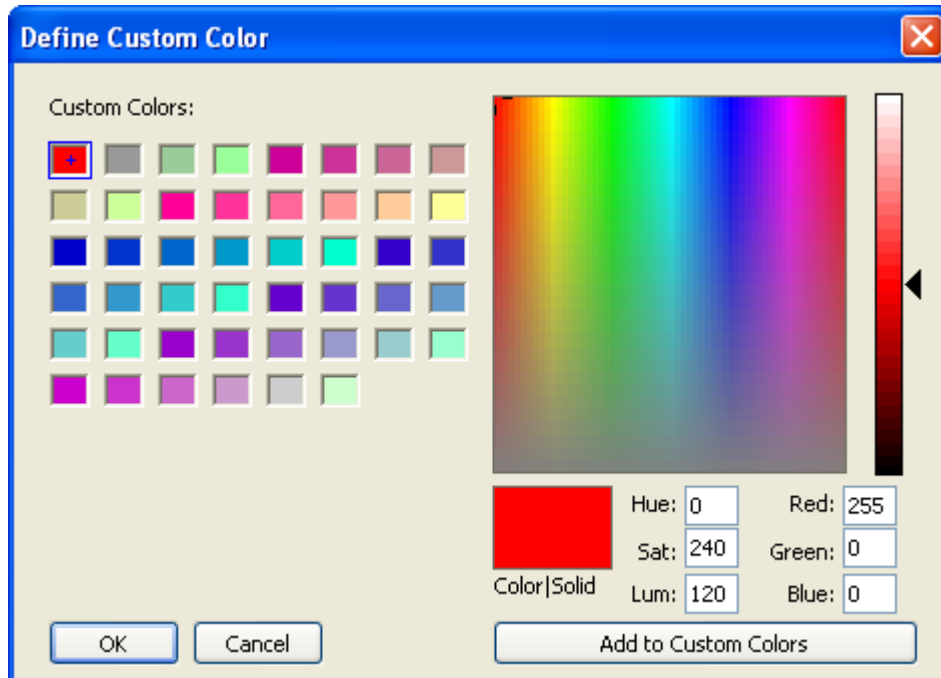



### 4.3.2. Selecting a Pattern

#### ■ Pattern Icons

In a dialog box, a Pattern icon is associated with a property that requires a pattern. It shows the pattern of the current selection and you can click it to bring up the Pattern palette. With the Pattern palette, you can select a pattern for the associated property. The following is a Pattern icon showing that the current selection is the “big dashes”.



#### ■ Pattern Palette

With the Pattern palette, you can select a pattern from a set of predefined patterns. Usually, you click a Pattern icon to bring up the Pattern palette as shown below.

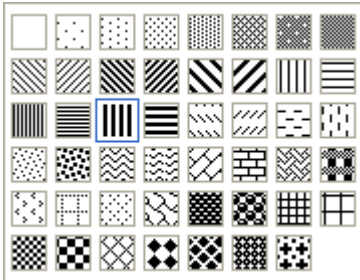



The “big dashes” block is outlined to indicate that it is the current selection. To select a pattern, click on that pattern block. To cancel the operation, click on any position other than the pattern blocks.

### 4.3.3. Selecting a Graphical Shape

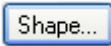
#### ■ Shape Buttons

In an object’s property dialog box, you can click the shape button  to bring up the Shape palette. With the Shape palette, you can select a graphical shape as the shape of the associated object.

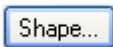
#### ■ Shape Palette

With the Shape palette, you can select a graphical shape for an object. Usually, you click  to bring up the Shape palette. The Shape palette contains several pages of graphical shapes. To select a graphical shape, click on that graphical shape. To select a page, click on that page’s number tab. To cancel the operation, click the close button  to close the Shape palette.

There are four sets of graphical shapes available for your applications. Each of them is suitable for certain kinds of objects. The Shape palette shows the set that is suitable for the type of the concerned object. The four sets of shapes are shown below.



Graphical shapes for buttons and switches

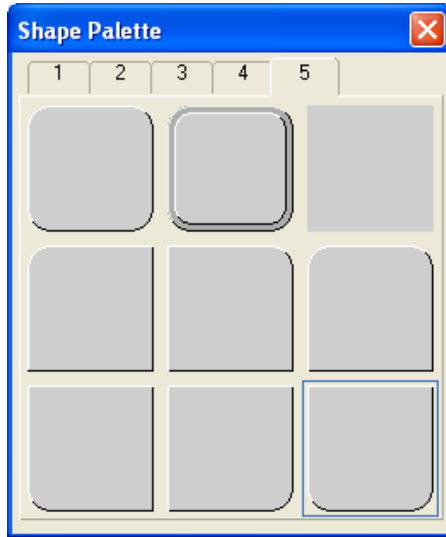
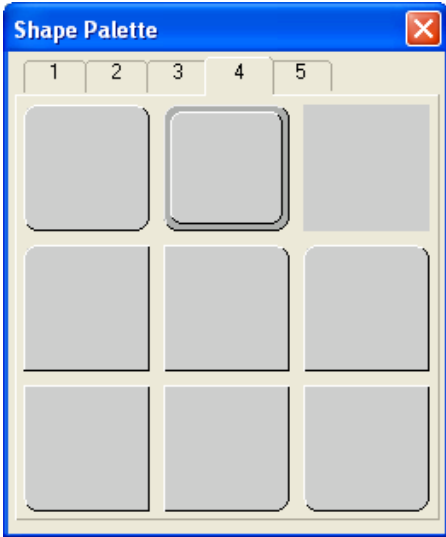
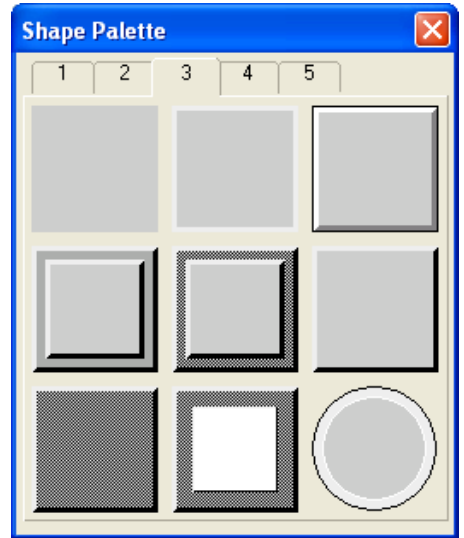
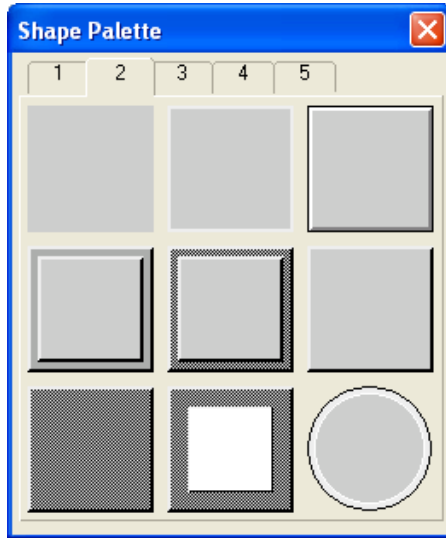
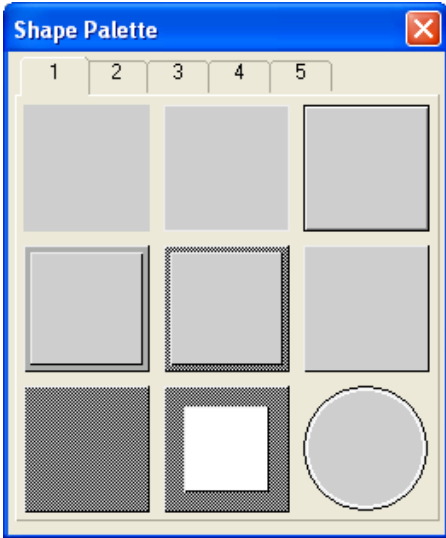

Graphical shapes for data entry objects

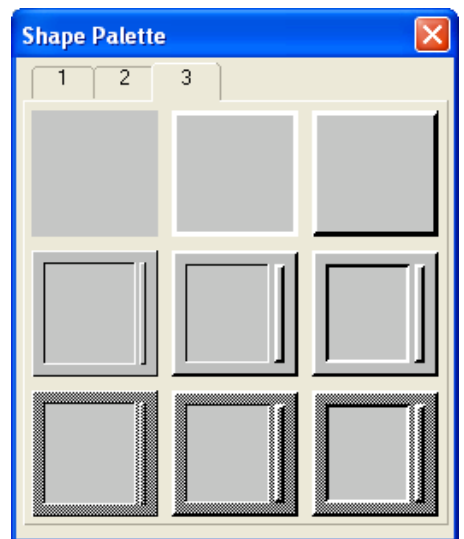
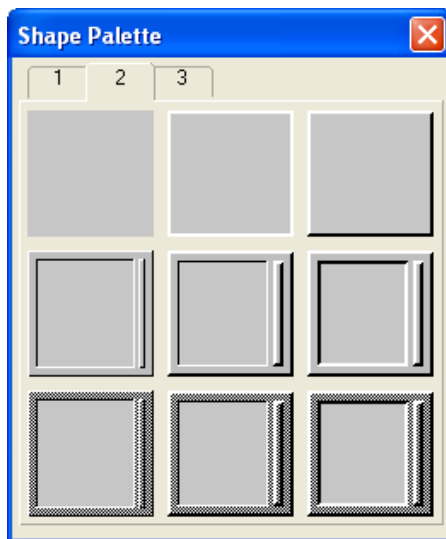
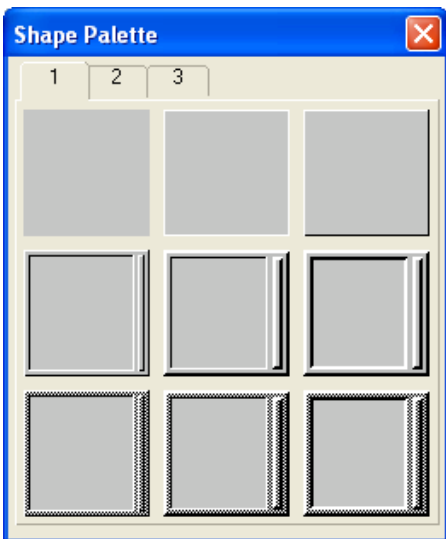

Graphical shapes for data display objects

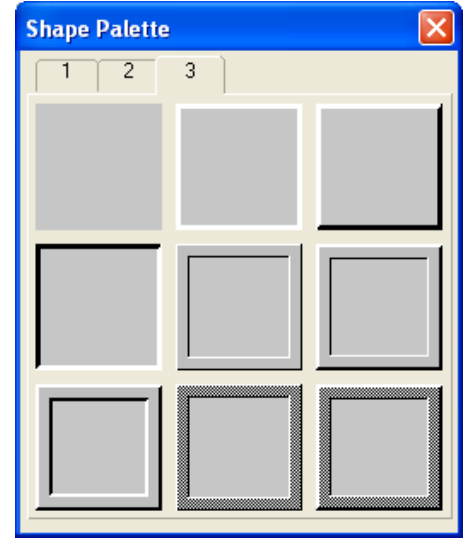
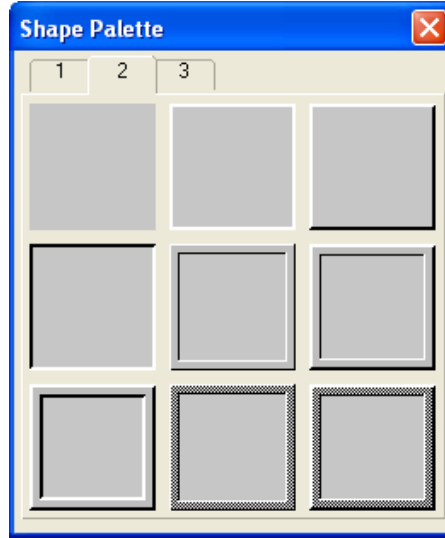
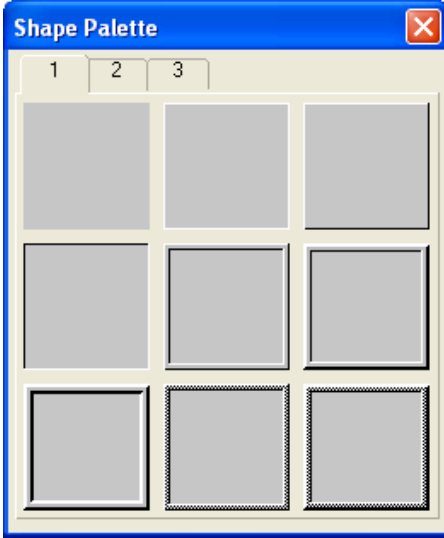

Graphical shapes for lamps

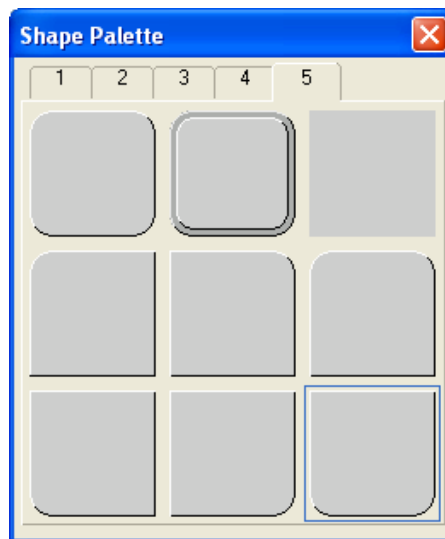
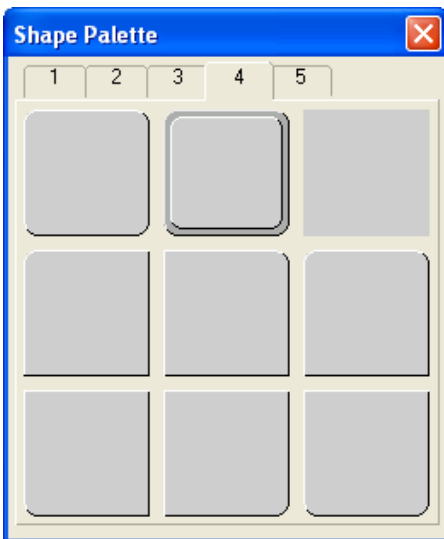
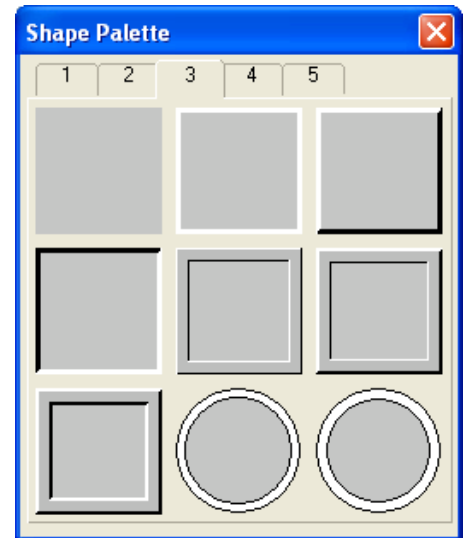
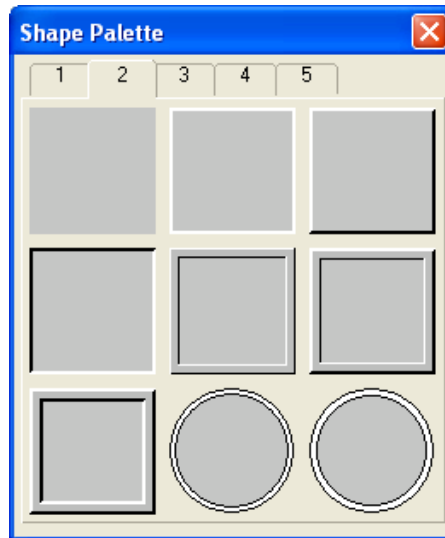
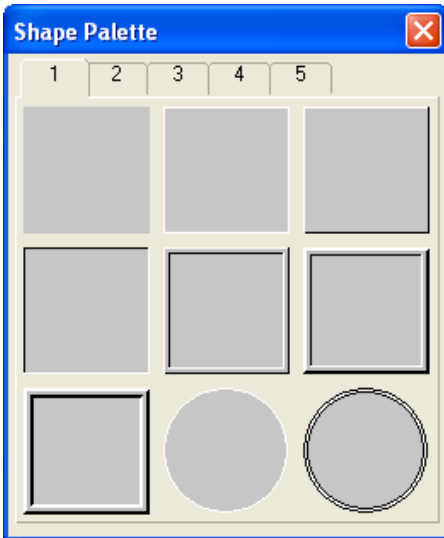

### 4.3.4. Setting up the Shape of an Object

This section describes how to set the shape of an object.

In order to give the operator a visual feedback for the touch action, most of the graphical shapes designed for the touch operable objects can change their look when touched. They can make the edge or border look pressed or show the outline with a different color.

The following examples are the shape settings of a bit button:

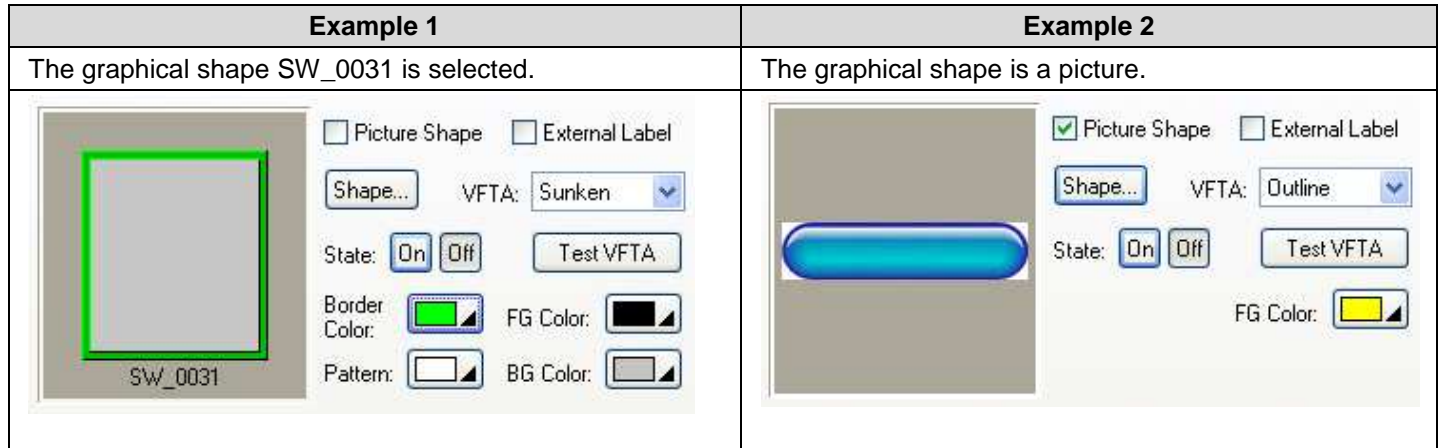

The following table describes each property that may be required for the settings of an object's shape.

Property	Description				
Picture Shape	Check this option if you want the object to have a picture shape instead of a graphical shape. This option is available when the object can have a picture shape.				
	Click this button to specify the shape of the object. When the Picture Shape is checked, the Select/Import from Library dialog box will display. Otherwise the Shape palette will display.				
VFTA	The type of VFTA (Visual Feedback for Touch Action).				
Test VFTA	Click this button to view the selected VFTA.				
Border Color	The border color of the graphical shape. Click the corresponding Color icon to specify the color.				
Pattern	The pattern that is used to fill the area inside the border of the graphical shape for the current (object) state. To specify the pattern, click the corresponding Pattern icon and select a pattern from the Pattern palette. This item is available when the area inside the graphical shape needs be painted.				
FG Color	<p>The color that is used to paint the black part of the pattern for the current (object) state. When the solid white pattern is selected, this color is not used. When a picture shape is used, this color is used for the outline mode with VFTA.</p> <table border="1" style="width: 100%;"> <thead> <tr> <th style="text-align: center;">Example 1</th> <th style="text-align: center;">Example 2</th> </tr> </thead> <tbody> <tr> <td> </td> <td> </td> </tr> </tbody> </table> <p>To specify the color, click the corresponding Color icon and select a color from the Color palette. This item is available when the area inside the graphical shape needs be painted.</p>	Example 1	Example 2		
Example 1	Example 2				
BG Color	The color that is used to paint the white part of the pattern for the current object state. To specify the color, click the corresponding Color icon and select a color from the Color palette. This item is available when the area inside the graphical shape needs be painted.				

### 4.3.5. Label Settings

This section describes how to set up the inner label for the following types of objects:

Bit Button, Toggle Switch, Screen Button, Function Button, Word Button, Keypad Button, and Bit Lamp.

The property sheets of the above mentioned objects provide you the Label page to set up the inner label. If an object has only one state, the Label page has the Text sub-page and the Picture sub-page for you to set up the text and the picture of the inner label respectively. If an object has two states, the Label page has the following four sub-pages:

Sub-page	For Setting
OFF Text	Text of state 0 (Off)
OFF Picture	Picture of state 0 (Off)
ON Text	Text of state 1 (On)
ON Picture	Picture of state 1 (On)

You can use the Label page to set the inner label of an object that can have at most two states. The following is an example of the Label page.

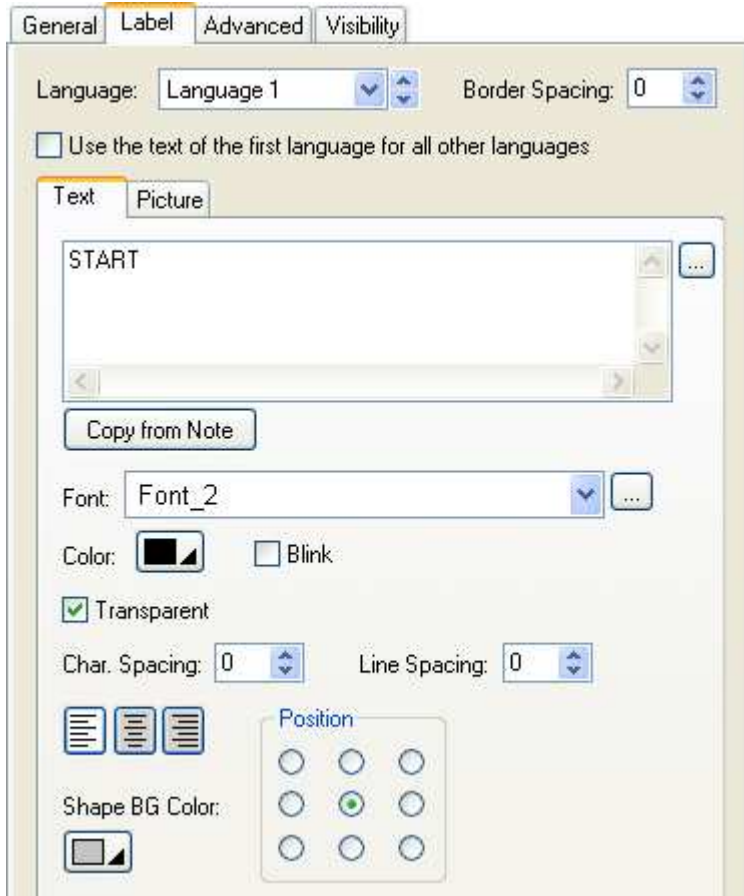

The following table describes only the properties in the Label page that are common to all its sub-pages. The properties of each of its sub-pages are described in the specific section about that sub-page.

Property	Description
Language	The language that you are setting the text for.
Border Spacing	The margin (in pixels) to the border of the object's shape for both the text body and picture.
Use the text of the first language for all other languages	Check this item so the inner label always shows the text of the first language regardless of what the current language is.
Text tab	Click this tab to bring up the Text sub-page.
Picture tab	Click this tab to bring up the Picture sub-page.
OFF Text tab	Click this tab to bring up the OFF Text sub-page.
ON Text tab	Click this tab to bring up the ON Text sub-page.
OFF Picture tab	Click this tab to bring up the OFF Picture sub-page.
ON Picture tab	Click this tab to bring up the ON Picture sub-page.

### 4.3.5.1. Text Sub-page Settings

You can use the Text sub-page, OFF Text sub-page, and ON Text sub-page to set up the text of the inner label for the corresponding state and the current language. The language you are setting for is specified by the Language item in the Label page.

The following are examples of the Text pages:

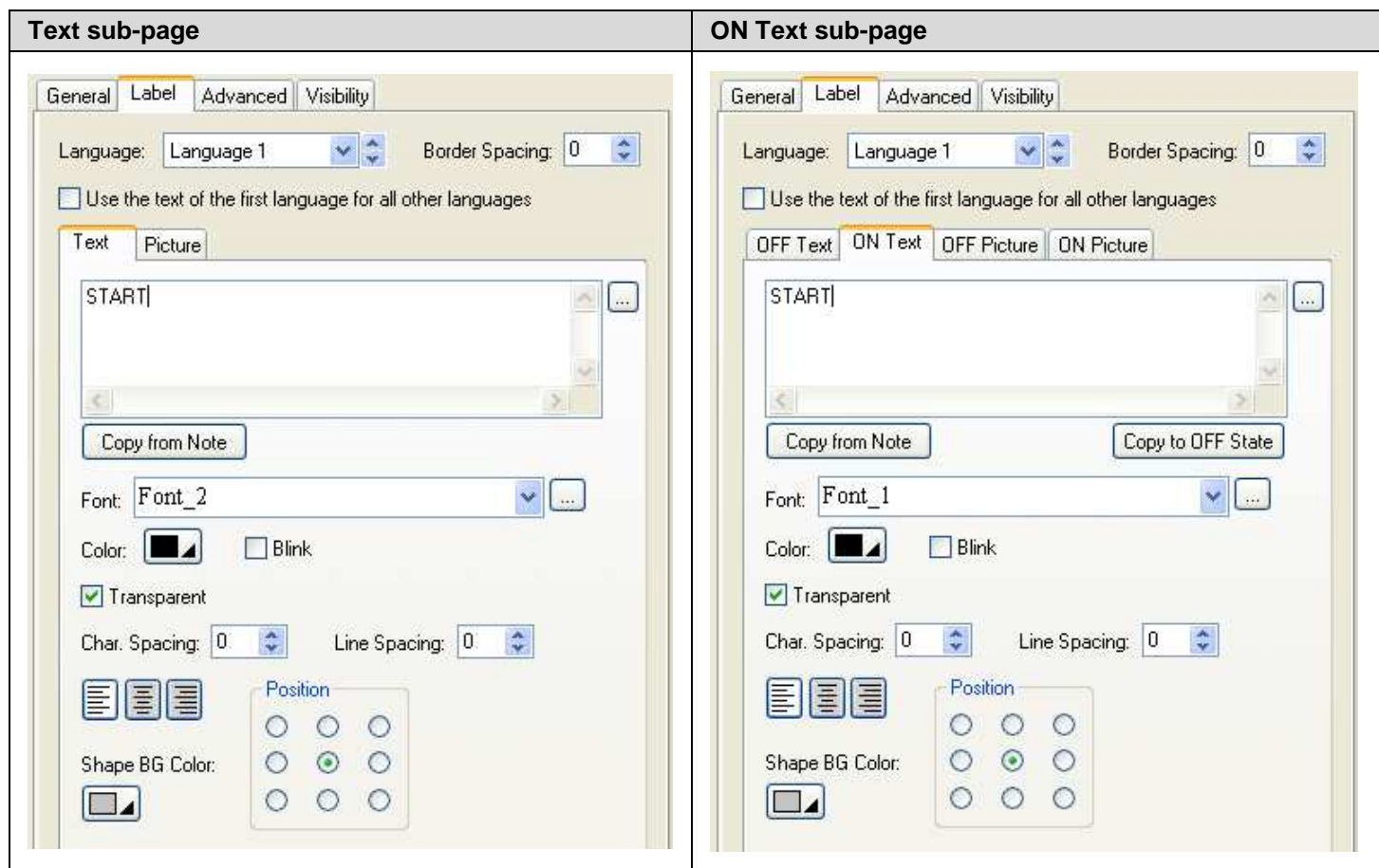



The following table describes each property in the Text sub-page, OFF Text sub-page, and ON Text sub-page.

Property	Description
Copy from Note	Click this button to replace the current text by the text of Note in the General page.
Copy to ON State	Click this button to use the current text to replace the text of ON state.
Copy to OFF State	Click this button to use the current text to replace the text of OFF state.
Font	The font of the text. You can use the drop-down list to select a font. Click  to bring up the Font Templates dialog box and select a font for the text. You can change the font templates before selecting a font in that dialog box.
Color	The color of the text. To specify the color, click the corresponding Color icon and select a color from the Color palette.
Blink	Check this item so the text will blink.
Transparent	Check this item to make the background of the characters transparent.
BG Color	The background color of the text.
Line Spacing	The distance (in pixels) between two adjacent lines of the text.
Character Spacing	The distance (in pixels) between two adjacent characters of the text.

Continued



Property	Description
	The alignment of the text.
Position 	The position of the text body.
Shape BG Color	The BG color of the object's shape for the current state.

### 4.3.5.2. Picture Sub-page Settings

You can use the Picture sub-page, OFF Picture sub-page, and ON Picture sub-page to set up the picture of the inner label for the corresponding state.

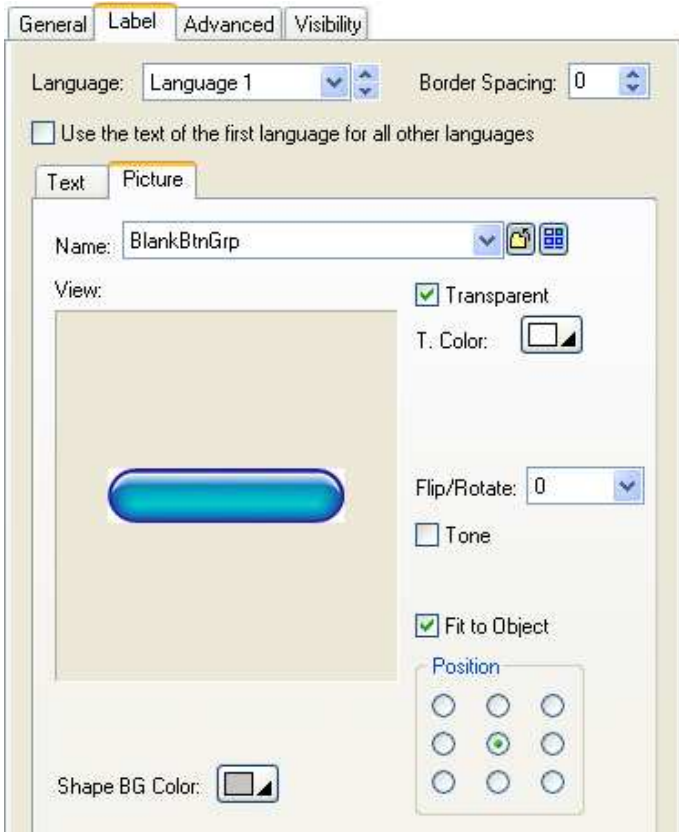
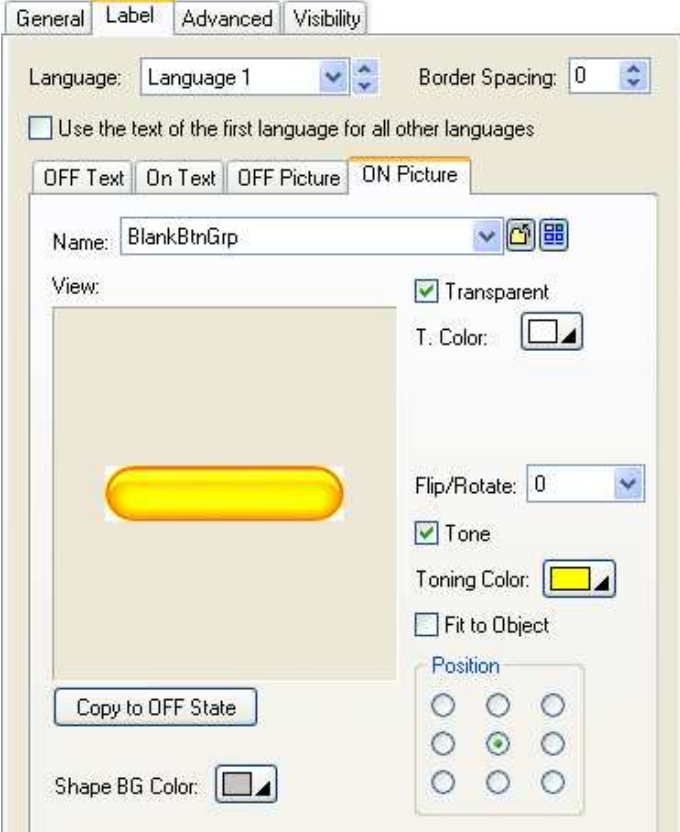

The following are examples of the Picture pages:

Picture sub-page	ON Picture sub-page.
	





The following table describes each property in the Picture sub-page, OFF Picture sub-page, and ON Picture sub-page.

Property	Description																		
Name	The name of the picture. You can use the drop-down list to select a picture from the picture database. Click  to select a picture file. After the selection, the picture of the selected file is imported and saved in the picture database. Click  to bring up the Select/Import from Library dialog box. Select a picture from a picture library file. After the selection, the selected picture is imported and saved in the picture database.																		
Copy to OFF State	Click this button to use the current picture to replace the picture of OFF state.																		
Copy to ON State	Click this button to use the current picture to replace the picture of ON state.																		
Transparent	Check this item to make parts of the picture transparent. The transparent parts are pixels whose colors are the same as the specified transparent color. This item is available when the picture is not a black and white picture.																		
T. Color	The transparent color.																		
FG Color	The color to paint the black part of a black and white picture. This item is available when the picture is a black and white picture.																		
BG Color	The color to paint the white part of a black and white picture. This item is available when the picture is a black and white picture.																		
Flip/Rotate	Specifies the method to flip or rotate the picture before drawing it. There are 8 options: <table border="1" data-bbox="300 945 1257 1393"> <thead> <tr> <th>Method</th> <th>Description</th> </tr> </thead> <tbody> <tr> <td>0°</td> <td>Do nothing</td> </tr> <tr> <td>90°</td> <td>Rotates the picture clockwise by 90 degree</td> </tr> <tr> <td>180°</td> <td>Rotates the picture clockwise by 180 degree</td> </tr> <tr> <td>270°</td> <td>Rotates the picture clockwise by 270 degree</td> </tr> <tr> <td>X</td> <td>Flips the picture over X axis</td> </tr> <tr> <td>90° &amp; X</td> <td>Rotates the picture clockwise by 90 degree and flips it over X Axis</td> </tr> <tr> <td>Y</td> <td>Flips the picture over Y axis</td> </tr> <tr> <td>90° &amp; Y</td> <td>Rotates the picture clockwise by 90 degree and flips it over Y Axis</td> </tr> </tbody> </table>	Method	Description	0°	Do nothing	90°	Rotates the picture clockwise by 90 degree	180°	Rotates the picture clockwise by 180 degree	270°	Rotates the picture clockwise by 270 degree	X	Flips the picture over X axis	90° & X	Rotates the picture clockwise by 90 degree and flips it over X Axis	Y	Flips the picture over Y axis	90° & Y	Rotates the picture clockwise by 90 degree and flips it over Y Axis
Method	Description																		
0°	Do nothing																		
90°	Rotates the picture clockwise by 90 degree																		
180°	Rotates the picture clockwise by 180 degree																		
270°	Rotates the picture clockwise by 270 degree																		
X	Flips the picture over X axis																		
90° & X	Rotates the picture clockwise by 90 degree and flips it over X Axis																		
Y	Flips the picture over Y axis																		
90° & Y	Rotates the picture clockwise by 90 degree and flips it over Y Axis																		
Tone	Check this item to tone the picture.																		
Toning Color	The color to tone the picture.																		
Fit to Object	Check this item so the picture can change its size automatically to just fit inside the border of the object's shape.																		
Position	 <p>The position of the picture within the object.</p>																		
Shape BG Color	The BG color of the object's shape for the current state.																		

### 4.3.6. Text Settings

This section describes how to set up the text of the inner label for the following types of objects:

Multi-state Switch, Radio Button Group, Step Button, Page Selector, Multi-state Lamp, Message Display, and Day-of-week Display.

The property sheets of the above mentioned objects provide you the Text page to set up the text of the inner label. The following is an example of the Text page.

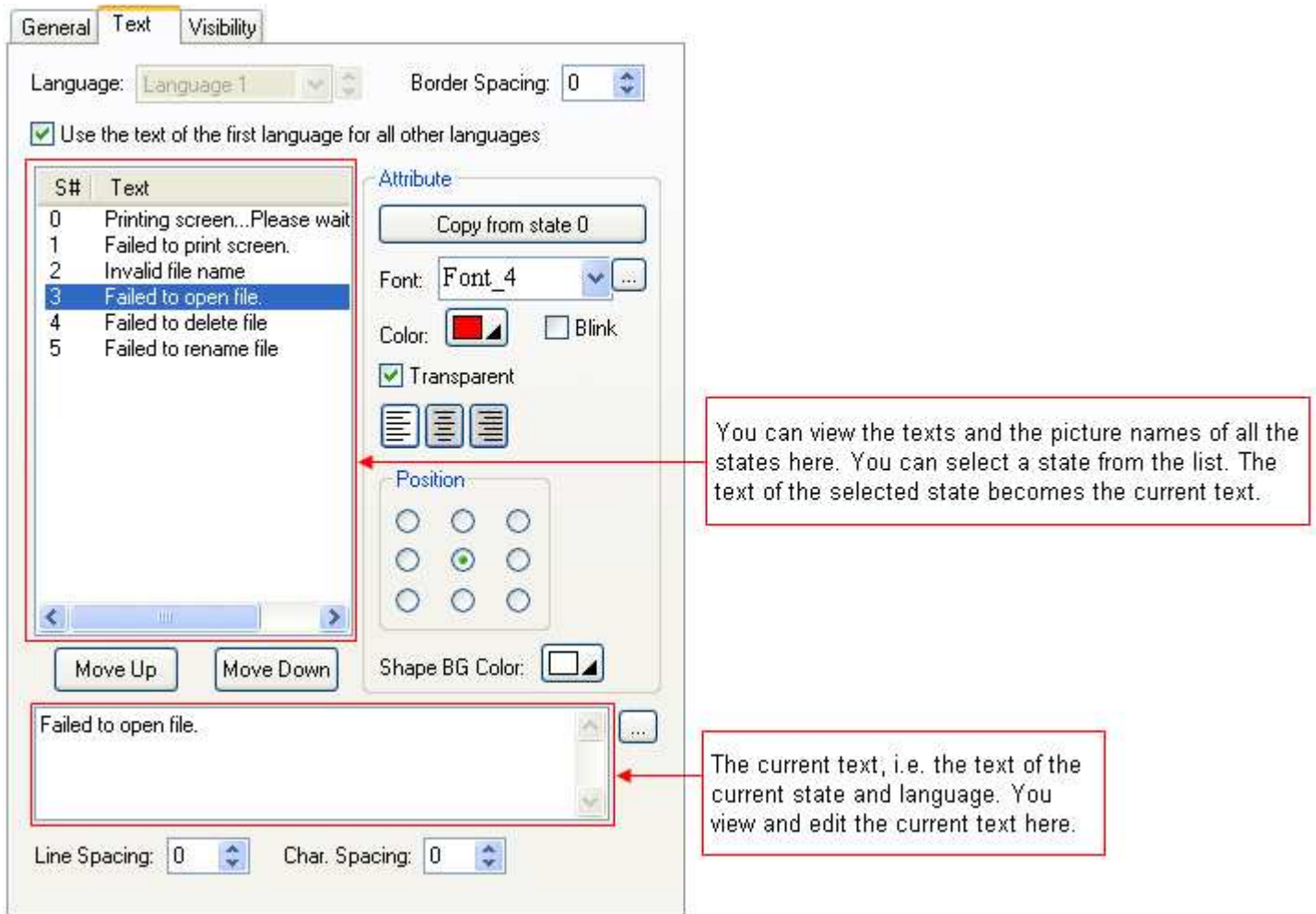

The screenshot shows the 'Text' tab of a property sheet. At the top, there are fields for 'Language' (set to 'Language 1') and 'Border Spacing' (set to 0). A checkbox 'Use the text of the first language for all other languages' is checked. Below this is a table with columns 'S#' and 'Text':

S#	Text
0	Printing screen...Please wait
1	Failed to print screen.
2	Invalid file name
3	Failed to open file.
4	Failed to delete file
5	Failed to rename file



To the right of the table is an 'Attribute' section with a 'Copy from state 0' button, a 'Font' dropdown (set to 'Font\_4'), a 'Color' selector (set to red), and a 'Blink' checkbox (unchecked). Below that is a 'Position' section with a 3x3 grid of radio buttons, where the center one is selected. There are also 'Move Up' and 'Move Down' buttons. At the bottom, there is a 'Shape BG Color' selector. A text input field at the bottom contains 'Failed to open file.' and has a callout box pointing to it. Another callout box points to the state list table.

The following table describes each property in the Text page.

Property	Description
Language	The language that you are setting the text for.
Border Spacing	The margin (in pixels) to the border of the object's shape for the text body.
Use the text of the first language for all other languages	Check this item so the inner label always shows the text of the first language regardless of what the current language is.
Move Up	Click this button to move the current text (and picture) up in the list and thus the associated state number of the current text (and picture) is decreased by one.
Move Down	Click this button to move the current text (and picture) down in the list and thus the associated state number of the current text (and picture) is increased by one.

Continued

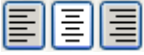

Property	Description
Copy to all states...	Click this button to use the text of state 0 to replace the text of all other states.
Copy from state 0...	Click this button to use the text of state 0 to replace the current text.
Font	The font of the current text. You can use the drop-down list to select a font. Click  to bring up the Font Templates dialog box and select a font for the current text. You can change the font templates before selecting a font in that dialog box.
Color	The color of the current text. To specify the color, click the corresponding Color icon and select a color from the Color palette.
Blink	Check this item so the current text will blink.
Transparent	Check this item to make the background of the text transparent.
BG Color	The background color of the text.
	The alignment of the text.
Position 	The position of the text body.
Shape BG Color	The BG color of the object's shape for the current state.
Line Spacing	The distance (in pixels) between two adjacent lines of the text.
Character Spacing	The distance (in pixels) between two adjacent characters of the text.

### 4.3.7. Picture Settings

This section describes how to define the picture settings for the following types of objects:

Multi-state Switch, Radio Button Group, Step Button, Page Selector, Multi-state Lamp, Picture Display, and Animated Graphic.

The property sheets of the above mentioned objects provide you the Picture page to define the picture settings of the objects. The following is an example of the Picture page.

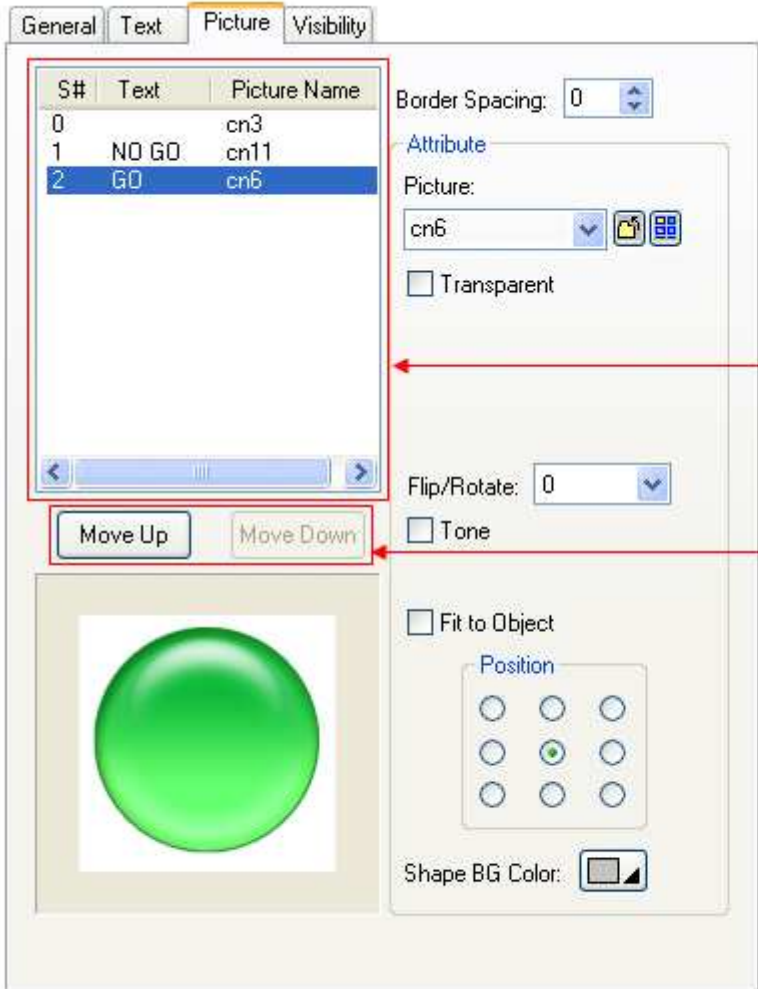



You can view the picture names and the texts of all the states here. You can select a state from the list. The picture of the selected state becomes the current picture.

Click [Move Up] to move the current picture (and text) up in the list and thus the associated state number of the current picture (and text) is decreased by one.

Click [Move Down] to move the current picture (and text) down in the list and thus the associated state number of the current picture (and text) is increased by one.

The following table describes each property in the Picture page.

Property	Description
Picture	<p>The name of the current picture. You can use the drop-down list to select a picture from the picture database.</p> <p>Click  to select a picture from a file as the current picture. After the selection, PM Designer imports the picture of the selected file and saves the picture in the picture database.</p> <p>Click  to bring up the Select/Import from Library dialog box. Select a picture from a picture library file as the current picture. After the selection, PM Designer imports the selected picture from the selected library and saves the picture in the picture database.</p>

Continued

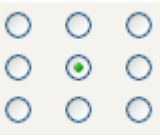

Property	Description																		
Transparent	Check this item to make parts of the current picture transparent. The transparent parts are pixels whose colors are identical to the specified transparent color. This item is available when the current picture is not a black and white picture.																		
Transparent Color	The transparent color.																		
FG Color	The color to paint the black part of a black and white picture. This item is available when the current picture is a black and white picture.																		
BG Color	The color to paint the white part of a black and white picture. This item is available when the current picture is a black and white picture.																		
Flip/Rotate	Specifies the method to flip or rotate the current picture before drawing it. There are 8 options: <table border="1" data-bbox="304 611 1294 994"> <thead> <tr> <th>Method</th> <th>Description</th> </tr> </thead> <tbody> <tr> <td>0°</td> <td>Do nothing</td> </tr> <tr> <td>90°</td> <td>Rotates the picture clockwise by 90 degree</td> </tr> <tr> <td>180°</td> <td>Rotates the picture clockwise by 180 degree</td> </tr> <tr> <td>270°</td> <td>Rotates the picture clockwise by 270 degree</td> </tr> <tr> <td>X</td> <td>Flips the picture over X axis</td> </tr> <tr> <td>90° &amp; X</td> <td>Rotates the picture clockwise by 90 degree and flips it over X Axis</td> </tr> <tr> <td>Y</td> <td>Flips the picture over Y axis</td> </tr> <tr> <td>90° &amp; Y</td> <td>Rotates the picture clockwise by 90 degree and flips it over Y Axis</td> </tr> </tbody> </table>	Method	Description	0°	Do nothing	90°	Rotates the picture clockwise by 90 degree	180°	Rotates the picture clockwise by 180 degree	270°	Rotates the picture clockwise by 270 degree	X	Flips the picture over X axis	90° & X	Rotates the picture clockwise by 90 degree and flips it over X Axis	Y	Flips the picture over Y axis	90° & Y	Rotates the picture clockwise by 90 degree and flips it over Y Axis
Method	Description																		
0°	Do nothing																		
90°	Rotates the picture clockwise by 90 degree																		
180°	Rotates the picture clockwise by 180 degree																		
270°	Rotates the picture clockwise by 270 degree																		
X	Flips the picture over X axis																		
90° & X	Rotates the picture clockwise by 90 degree and flips it over X Axis																		
Y	Flips the picture over Y axis																		
90° & Y	Rotates the picture clockwise by 90 degree and flips it over Y Axis																		
Tone	Check this item to tone the current picture.																		
Toning Color	The color to tone the current picture.																		
Fit to Object	Check this item so the current picture can change its size automatically to just fit inside the border of the object's shape.																		
Position	The position of the current picture within the object. 																		
Shape BG Color	The BG color of the object's shape for the current state.																		

### 4.3.8. External Label Settings







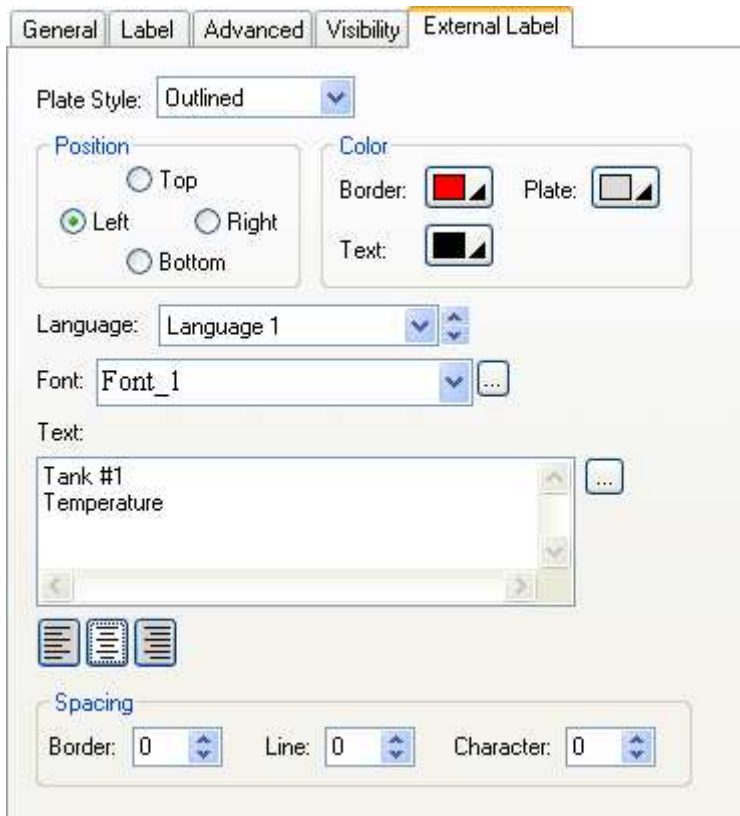





This section describes how to set up the external label for the following types of objects:

Bit Button, Toggle Switch, Screen Button, Slide Switch, Word Button, Multi-state Switch, Radio Button Group, Step Button, Numeric Entry, Numeric Display, Advanced Numeric Display, ASCII String Entry, ASCII String Display, Bit Lamp, Multi-state Lamp, Message Display, Picture Display, and Bar Graph.

You can use the External Label page in an object's property sheet to set up the external label of that object. The following is an example of the External Label page.



The following table describes each property in the External Label page.

Property	Description										
Plate Style	Specifies the plate type of the external label. There are four plate types as shown below:										
	<table border="1"> <thead> <tr> <th>Plate Type</th> <th>Example</th> </tr> </thead> <tbody> <tr> <td>Transparent,</td> <td>  </td> </tr> <tr> <td>Flat,</td> <td>  </td> </tr> <tr> <td>Outlined</td> <td>  </td> </tr> <tr> <td>Raised</td> <td>  </td> </tr> </tbody> </table>	Plate Type	Example	Transparent,		Flat,		Outlined		Raised	
	Plate Type	Example									
	Transparent,										
	Flat,										
Outlined											
Raised											

Continued



Property		Description										
Position		<p>Specifies the position of the external label relative to the object. There are four positions as shown below:</p> <table border="1"> <thead> <tr> <th>Position</th> <th>Example</th> </tr> </thead> <tbody> <tr> <td>Top</td> <td> </td> </tr> <tr> <td>Left</td> <td> </td> </tr> <tr> <td>Right</td> <td> </td> </tr> <tr> <td>Bottom</td> <td> </td> </tr> </tbody> </table>	Position	Example	Top		Left		Right		Bottom	
Position	Example											
Top												
Left												
Right												
Bottom												
Color	Border	The border color of the plate. To specify the color, click the corresponding Color icon and select a color from the Color palette.										
	Plate	The color of the plate. To specify the color, click the corresponding Color icon and select a color from the Color palette.										
	Text	The color of the text. To specify the color, click the corresponding Color icon and select a color from the Color palette.										
Language		The language that you are setting the text for.										
Font	<Drop-down List>	The font of the text for the current language										
		Click this button to bring up the Font Templates dialog box and select a font for the text. You can change the font templates before selecting a font in that dialog box.										
Text	<Edit Box>	The text for the current language.										
		Click this button to bring up the Text Source dialog box and select a string for the current text. You can change the text database before selecting a string in that dialog box.										
		The alignment of the text.										
Spacing	Border	The distance (in pixels) between the plate border and the text body.										
	Line	The distance (in pixels) between two adjacent lines of the text.										
	Character	The distance (in pixels) between two adjacent characters of the text.										





## 4.4. Setting up Objects

### 4.4.1. States of Objects

When an object has multiple states, its appearance automatically has the same number of states. You need to specify the settings of the shape and the inner label of an object for each state. Usually the state of an object is determined by the value of the variable it monitors. An object that monitors a bit has state 0 (off) and state 1 (on). An object that monitors a word or a double-word can have up to 256 states.

#### 4.4.1.1. State Types

You need to specify the state type for an object so the object knows how to determine its state. The following table describes each of the four state types.

State Type	For	How to decide the state
Bit	Bit Variable	The state is the value of the variable. <b>Example:</b> 1)The state of \$U1.3 is 0 when \$U1.3 is 0 (off). 2)The state of WX3.f is 1 when WX3.f is 1 (on).
Value	Word Variable, Double-word Variable	The state is the value of the variable. The valid states are from 0 to 255. <b>Example:</b> 1)The state of \$U200 is 123 when \$U200 is 123. 2)The state of WX20 is 0 when WX20 is 0. 3)The state of \$N300 is invalid when \$N300 is 999.
LSB	Word Variable, Double-word Variable	The state is the number of the least significant bit of the variable's value that is 1 (on). For a word variable, the valid state are from 0 to 16 and state 16 means all the bits are 0. For a double-word variable, the valid state are from 0 to 32 and state 32 means all the bits are 0. <b>Example:</b> 1)The state of \$U200 is 1 when \$U200 is 246H. 2)The state of WX20 is 19 when WX20 is 80000H. 3)The state of \$N300 is 16 when \$N300 is 0.
Custom	Word Variable, Double-word Variable	When you configure an object with the Custom state type, you assign each valid state a unique number which is called a state value. The assigned state values will be used to determine the state of the object. If the variable's value is equal to one of the state values, the corresponding state of that state value is the state of the object. If the value is equal to none of the state values, the state is invalid. <b>Example:</b> An object monitors \$U100 and its state type is Custom. There are three valid states and you assigned 300, 200, and 100 to state 0, 1, and 2 respectively. The state is 2 when \$U100 is 100 and the state is 0 when \$U100 is 300.



#### 4.4.1.2. Setting the Custom States of an Object

In the General page of the object's property dialog box, with the Custom state type selected, click the Custom State Value... button to bring up the Custom State Value dialog box as the example shown below.

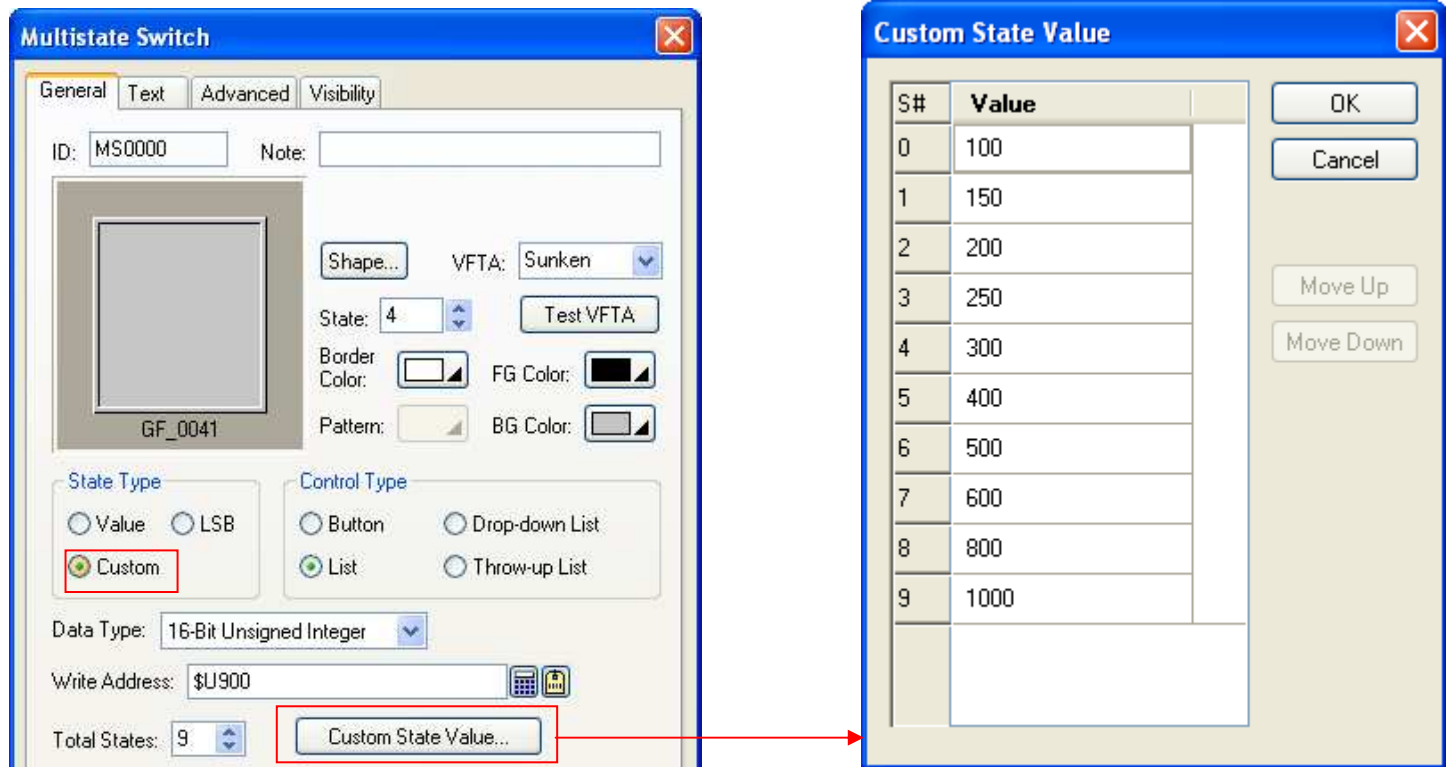

You can assign a positive integer for each state in that dialog box. To edit the value, click the row of that state on its value column.

You can use the Move Up button and the Move Down button to adjust the position of state values. To move up or move down the state values, you need to make a selection first. To select a state, click the header column. To select multiple rows, click the header column and use Ctrl+Click to add a row to the selection.



### 4.4.2. Operation Options of Objects

The following table explains operation options which can be added to an object to make it more informative, secure, and useful.

Terminology	Definition
Enabling and disabling the touch operation	<p>The touch operation can be enabled and disabled either by a specified bit or by the current user level. You can choose to display the touch operation disabled sign on the button when the touch operation is disabled.</p> <p>If the touch operation is to be enabled by a bit, you need to specify that bit and the bit value that enables the touch operation.</p> <p>If the touch operation is to be enabled by the current user level, you need to specify the lowest user level that is required to enable the touch operation.</p> <p>Select and set this feature in the Advanced page of the Bit Button dialog box.</p>
Requiring the minimum hold time	<p>The touch operation will not be activated until the button is pressed and held down for the specified Minimum Hold Time.</p> <p>Select and set this feature in the Advanced page of the Bit Button dialog box.</p>
Requiring the operator confirmation	<p>A confirmation dialog box displays when the button is activated to about to set a bit. The button will proceed to set that bit if the operator selects “Yes” to confirm the operation. The touch operation will be cancelled if the operator selects “No” to reject the operation or the operator does not respond within the Maximum Waiting Time.</p> <p>This feature is available for the following operations: Set ON, Set OFF, Set ON Pulse, Set OFF Pulse, and Invert.</p> <p>Select and set this feature in the Advanced page of the Bit Button dialog box.</p>
Notifying a bit of the touch operation	<p>The notification is performed after the touch operation is done. You need to specify the bit to be notified and the bit value to be used for the notification.</p> <p>Select and set this feature in the Advanced page of the Bit Button dialog box.</p>
Logging the touch operations	<p>The time and data when the touch operation occurs, the new value that is written to the bit, and the predefined text can be recorded in the operation log with this feature.</p> <p>Select and set this feature in the Advanced page of the Bit Button dialog box.</p>
Showing and hiding an object	<p>The visibility of an object can be controlled either by a specified bit or by the current user level, i.e. an object can be shown and hidden dynamically by any of those two methods.</p> <p>If the visibility is to be controlled by a bit, you need to specify that bit and the bit value that shows the object.</p> <p>If the visibility is to be controlled by the current user level, you need to specify the lowest user level that is required to show the visibility.</p> <p><b>Note 1:</b> When an object is invisible, the touch operation is automatically disabled. <b>Note 2:</b> It is allowed to simply set an object invisible. The touch operation is still enabled with this setting.</p> <p>Select and set this feature in the Visibility page of the object setting dialog box.</p>



### 4.4.3. Address Settings

This chapter describes the terms, rules, and methods to address data.

#### 4.4.3.1. Terminologies for Data Accessing









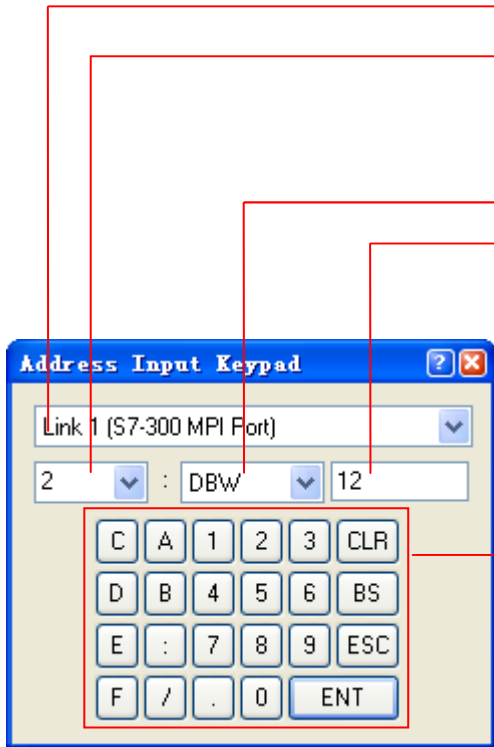



The following table explains variables, addresses and tags.

Terminology	Definition
Internal memory	The memory space in the target panel that can be accessed by the panel application. For example, the user memory \$U, the non-volatile memory \$N, the system memory \$S, and the recipe memory \$R are all parts of the internal memory.
Internal variable	An address or a tag referring to an address of a space in the internal memory.
Internal bit variable	An internal variable that refers to a bit in the internal memory.  For easy to read, we usually use “internal variable” instead of “internal bit variable” when referring to a bit if there is no ambiguity.
Internal word variable	An internal variable that refers to a word in the internal memory. The variables can also be used to refer to a double-word, a block of bytes (byte array), a block of words (word array), and a block of double-words (double-word array).  For easy to read, we usually use “internal variable” instead of “internal word variable” when referring to a word or a block of memory space if there is no ambiguity,
External memory	The memory spaces or the collections of addressable devices in the controllers that can be accessed by the panel application through communication links.
External variable	An address or a tag referring to an address of a space in the external memory.
External bit variable	An external variable that refers to a bit in the external memory.  For easy to read, we usually use “external variable” instead of “external bit variable” when referring to a bit if there is no ambiguity.
External word variable	An external variable that refers to a word in the external memory. The variables can also be used to refer to a double-word, a block of bytes (byte array), a block of words (word array), and a block of double-words (double-word array) if the access unit of the associated addresses is word. If the access unit is double-word, you can only use the variable to refer to a double-word or a block of memory space with a length of a multiple of 4 (bytes).  For easy to read, we usually use “external variable” instead of “external word variable” when referring to a word or a block of memory space if there is no ambiguity,
Variable	An internal variable or an external variable.
Bit variable	An internal bit variable or an external bit variable.
Word variable	An internal word variable or an external word variable.
Double-word variable	An internal variable or an external variable that refers to a double-word.
Byte array variable	An internal variable or an external variable that refers to a byte array.
Word array variable	An internal variable or an external variable that refers to a word array.
Double-word array variable	An internal variable or an external variable that refers to a double-word array.
Tag	A name that stands for an address of the internal memory or the external memory. It also specifies the data type and scan rate of the data in the memory location it refers to.

### 4.4.3.2. Address Input Keypad

With the address input keypad, you can enter an address easily. Usually, you click  to bring up the address input keypad as shown below.

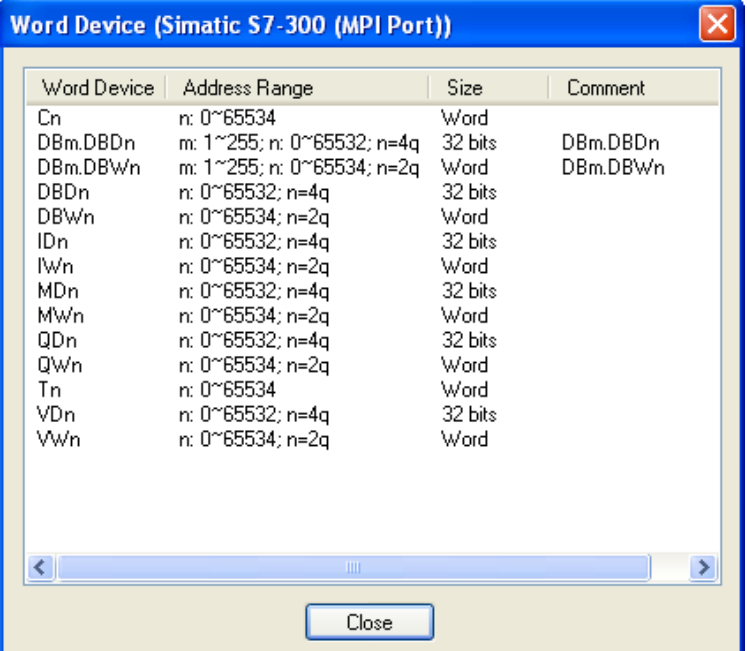

Property	Description																																																												
Link	Click the down arrow and select a link from the drop down list.																																																												
PLC Address	Click the down arrow and select a value between 0 and 255 or an indirect address between [\$I0] and [\$I15] as the PLC Address. If the indirect address is used, the plc address can be dynamic changed.																																																												
Location Type	Click the down arrow and select an item from the drop down list as the location type.																																																												
Address	Specify the address.																																																												
Input keypad	<table border="1"> <thead> <tr> <th>Buttons</th> <th>Description</th> </tr> </thead> <tbody> <tr> <td></td> <td>Clears all the texts in the address field.</td> </tr> <tr> <td></td> <td>Deletes all selected texts, if any, or the text character to the left of the cursor in the address field.</td> </tr> <tr> <td></td> <td>Cancel the address input and escapes the dialog.</td> </tr> <tr> <td></td> <td>Checks and enters the address if valid.</td> </tr> <tr> <td>Others</td> <td>Click to specify the address. Only available when the Address field holds the input focus.</td> </tr> </tbody> </table>	Buttons	Description		Clears all the texts in the address field.		Deletes all selected texts, if any, or the text character to the left of the cursor in the address field.		Cancel the address input and escapes the dialog.		Checks and enters the address if valid.	Others	Click to specify the address. Only available when the Address field holds the input focus.																																																
	Buttons	Description																																																											
		Clears all the texts in the address field.																																																											
		Deletes all selected texts, if any, or the text character to the left of the cursor in the address field.																																																											
		Cancel the address input and escapes the dialog.																																																											
		Checks and enters the address if valid.																																																											
Others	Click to specify the address. Only available when the Address field holds the input focus.																																																												
	Click the help button to see how to specify word or bit devices and their addresses for the specified link in the following popup dialog.																																																												
 <table border="1"> <thead> <tr> <th>Word Device</th> <th>Address Range</th> <th>Size</th> <th>Comment</th> </tr> </thead> <tbody> <tr> <td>Cn</td> <td>n: 0~65534</td> <td>Word</td> <td></td> </tr> <tr> <td>DBm.DBDbn</td> <td>m: 1~255; n: 0~65532; n=4q</td> <td>32 bits</td> <td>DBm.DBDbn</td> </tr> <tr> <td>DBm.DBWn</td> <td>m: 1~255; n: 0~65534; n=2q</td> <td>Word</td> <td>DBm.DBWn</td> </tr> <tr> <td>DBDn</td> <td>n: 0~65532; n=4q</td> <td>32 bits</td> <td></td> </tr> <tr> <td>DBWn</td> <td>n: 0~65534; n=2q</td> <td>Word</td> <td></td> </tr> <tr> <td>IDn</td> <td>n: 0~65532; n=4q</td> <td>32 bits</td> <td></td> </tr> <tr> <td>IWn</td> <td>n: 0~65534; n=2q</td> <td>Word</td> <td></td> </tr> <tr> <td>MDn</td> <td>n: 0~65532; n=4q</td> <td>32 bits</td> <td></td> </tr> <tr> <td>MWn</td> <td>n: 0~65534; n=2q</td> <td>Word</td> <td></td> </tr> <tr> <td>QDn</td> <td>n: 0~65532; n=4q</td> <td>32 bits</td> <td></td> </tr> <tr> <td>QWn</td> <td>n: 0~65534; n=2q</td> <td>Word</td> <td></td> </tr> <tr> <td>Tn</td> <td>n: 0~65534</td> <td>Word</td> <td></td> </tr> <tr> <td>VDn</td> <td>n: 0~65532; n=4q</td> <td>32 bits</td> <td></td> </tr> <tr> <td>VWn</td> <td>n: 0~65534; n=2q</td> <td>Word</td> <td></td> </tr> </tbody> </table>		Word Device	Address Range	Size	Comment	Cn	n: 0~65534	Word		DBm.DBDbn	m: 1~255; n: 0~65532; n=4q	32 bits	DBm.DBDbn	DBm.DBWn	m: 1~255; n: 0~65534; n=2q	Word	DBm.DBWn	DBDn	n: 0~65532; n=4q	32 bits		DBWn	n: 0~65534; n=2q	Word		IDn	n: 0~65532; n=4q	32 bits		IWn	n: 0~65534; n=2q	Word		MDn	n: 0~65532; n=4q	32 bits		MWn	n: 0~65534; n=2q	Word		QDn	n: 0~65532; n=4q	32 bits		QWn	n: 0~65534; n=2q	Word		Tn	n: 0~65534	Word		VDn	n: 0~65532; n=4q	32 bits		VWn	n: 0~65534; n=2q	Word	
Word Device	Address Range	Size	Comment																																																										
Cn	n: 0~65534	Word																																																											
DBm.DBDbn	m: 1~255; n: 0~65532; n=4q	32 bits	DBm.DBDbn																																																										
DBm.DBWn	m: 1~255; n: 0~65534; n=2q	Word	DBm.DBWn																																																										
DBDn	n: 0~65532; n=4q	32 bits																																																											
DBWn	n: 0~65534; n=2q	Word																																																											
IDn	n: 0~65532; n=4q	32 bits																																																											
IWn	n: 0~65534; n=2q	Word																																																											
MDn	n: 0~65532; n=4q	32 bits																																																											
MWn	n: 0~65534; n=2q	Word																																																											
QDn	n: 0~65532; n=4q	32 bits																																																											
QWn	n: 0~65534; n=2q	Word																																																											
Tn	n: 0~65534	Word																																																											
VDn	n: 0~65532; n=4q	32 bits																																																											
VWn	n: 0~65534; n=2q	Word																																																											

#### 4.4.3.3. Selecting Tags

To select a tag, you can click  to bring up the Select Tag dialog box as shown below.

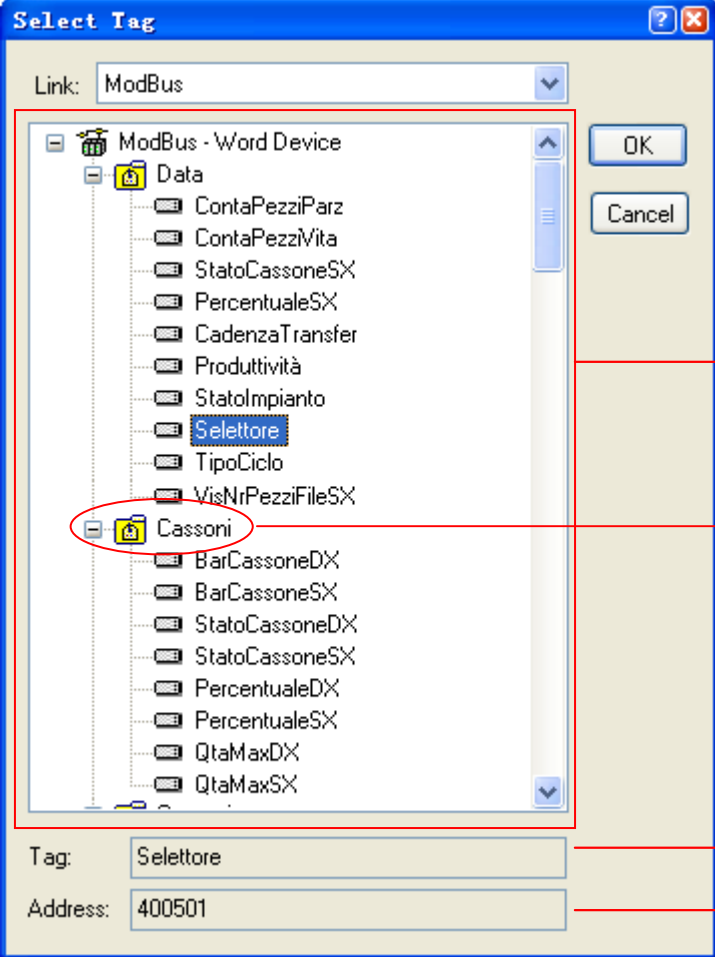

All the predefined word or bit tags for the selected link are listed. To use a tag, you can double click the tag you want or select a tag and then click the OK button.

Tag group

Selected tag

The address for the selected tag

**Note:** All the listed tags and tag groups are created in the Tags window. To create a tag, please see [Section 3.3 Creating Tags](#).



#### 4.4.4. Scale Settings

This section describes how to set up the scale for the following types of objects:

Slide Switch, Bar Graph, Circular Bar Graph, and Meter.

The following are examples of scales used in different kinds of objects.

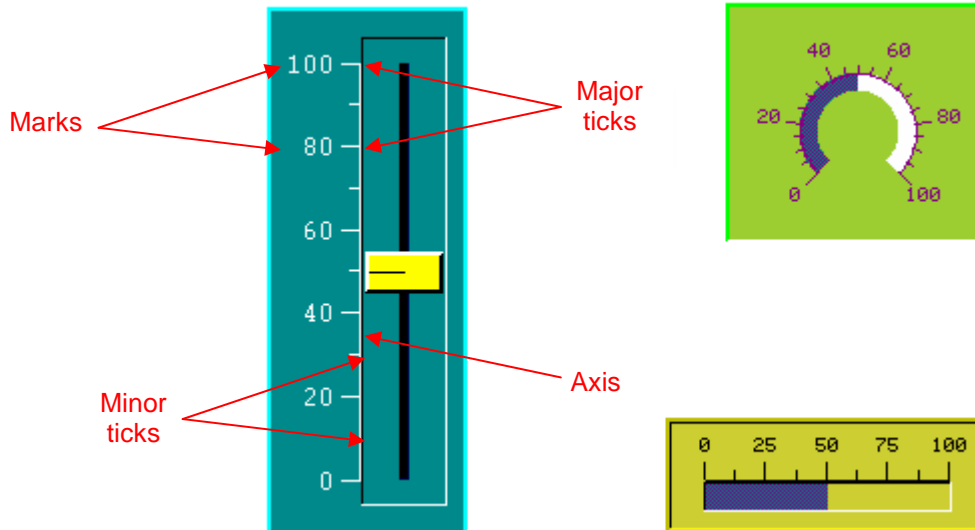

You can use the Scale page in an object's property sheet to set up the scale of that object. The following is an example of the Scale page.

General **Scale** F. Marker B. Marker Advanced Visibility

Scale

Position:  Top  Bottom

Color:

Number of Major Ticks: 5

Number of Sub Divisions: 2

Axis

Marks

Font:  6x8  8x12







Dynamic Range

Minimum: 0 Maximum: 100

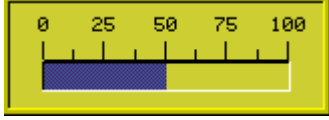
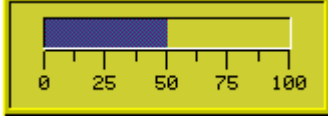
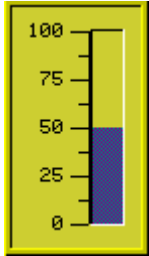
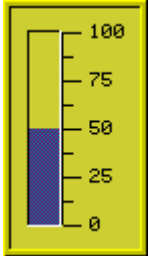
Total Digits: 3

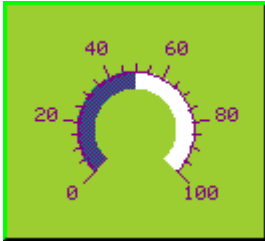
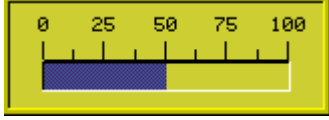
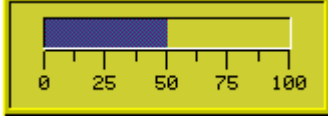
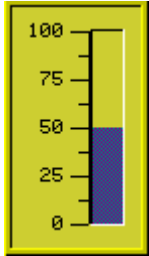
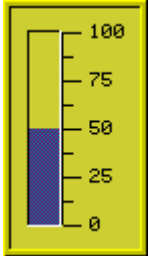
Fractional Digits: 0

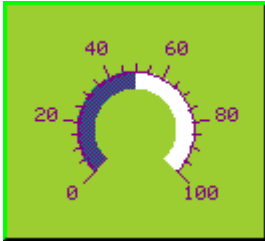
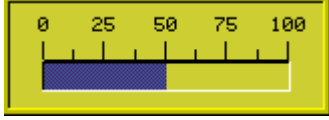
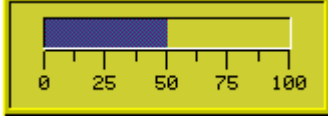
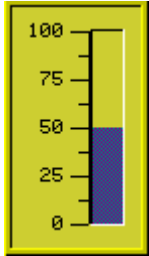
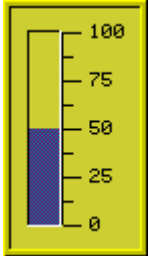
The following table describes each property in the Scale page.

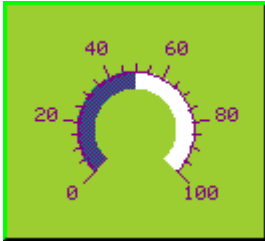
Property		Description																
Scale		Check this item if you want the object to have a scale.																
Position		Specifies the position of the scale in the object. The position is relative to the part of the object that displays the monitored variable. There are six positions shown below:																
	<table border="1"> <thead> <tr> <th>Position</th> <th>Example</th> <th>Position</th> <th>Example</th> </tr> </thead> <tbody> <tr> <td>Top</td> <td></td> <td>Bottom</td> <td></td> </tr> <tr> <td>Left</td> <td></td> <td>Right</td> <td></td> </tr> <tr> <td>Inner</td> <td></td> <td>Outer</td> <td></td> </tr> </tbody> </table>	Position	Example	Position	Example	Top		Bottom		Left		Right		Inner		Outer		
Position	Example	Position	Example															
Top		Bottom																
Left		Right																
Inner		Outer																
Color		The color of the scale. To specify the color, click the corresponding Color icon and select a color from the Color palette.																
Number of Major Ticks		The number of major ticks. The minimum you can specify is two.																
Number of Sub Divisions		The number of divisions between two adjacent major ticks. The minimum you can specify is one.																
Axis		Check this item if you want the scale to have an axis.																
Marks	Marks	Check this option if you want the scale to have marks.																
	Font	The font of the marks.																
	Dynamic Range	Check this option if you want the minimum and maximum of the marks to be controlled by the dynamic range parameter block of the associated object at runtime.																
	Minimum	The minimum of the marks. It is a 32-bit integer.																
	Maximum	The maximum of the marks. It is a 32-bit integer.																
	Total Digits	The total digits to be displayed for the marks.																
	Fractional Digits	The number of fractional digits for the marks. For example, when the Maximum is 5000, the Total Digits is 4, and the Fractional Digits is 2, the mark for the Maximum will be 50.00.																



### 4.4.5. Advanced Settings

This section describes how to define the advanced settings for the following types of objects:

Bit Button, Toggle Switch, Screen Button, Function Button, Slide Switch, Word Button, Multi-state Switch, Radio Button Group, Step Button, Advanced Numeric Display, ASCII String Entry, and Recipe Selector.

You can use the Advanced page in an object's property sheet to define the advanced settings of that object.

The following are examples of the Advanced page for different objects:

For an advanced numeric display.	For a bit button.

The following table describes each property in the Advanced page.

Property		Description
Touch Operation Control	Enabled by Bit	Check this option so the touch operation of the numeric entry will be enabled and disabled by the specified bit.
	Control Bit	Specifies the bit that enables and disables the touch operation. Click  to enter a bit address. Click  to select a bit tag.
	Enabling State	Specifies the state (On or Off) that enables the touch operation.
	Enabled by User Level	Check this item so the touch operation of the numeric entry will be enabled and disabled by the current user level.
	Lowest Enabling User Level	Specifies the lowest user level that is required to enable the touch operation.
	Show Disabled Sign	Check this option so the touch operation disabled sign will be shown on the numeric entry when the touch operation is disabled.

Continued





Property		Description						
Timeout	Timeout	Check this option so the data entry will be cancelled if the numeric keypad does not receive any input within the specified time.						
	Timeout Time	Specifies the maximum time that the numeric keypad will wait to get a new input. If there is no input within the specified time, the numeric keypad will be closed and the data entry will be cancelled.						
Notification	Notification	Check this option so the numeric entry will notify the specified bit after it finishes outputting the entered value to the destination variable.						
	Signal	Select one of the following signal for the notification: <table border="1" data-bbox="496 546 1497 678"> <thead> <tr> <th>Signal</th> <th>Description</th> </tr> </thead> <tbody> <tr> <td>Level</td> <td>Set the specified bit to the specified state.</td> </tr> <tr> <td>Pulse</td> <td>Send a positive pulse to the specified bit.</td> </tr> </tbody> </table>	Signal	Description	Level	Set the specified bit to the specified state.	Pulse	Send a positive pulse to the specified bit.
	Signal	Description						
	Level	Set the specified bit to the specified state.						
	Pulse	Send a positive pulse to the specified bit.						
Bit	Specifies the bit that receives the notification.							
State	Specifies the state (On or Off) that is used for the notification.							
Operator Confirmation	Operator Confirmation	Check this option if you want the operator to confirm what he/she enters for the numeric entry. The Confirmation box will be displayed when a value is entered for the numeric entry. If the operator selects "Yes" in the Confirmation box, the numeric entry will write the entered value to the specified variable. If the operator selects "No" or the operator does not respond within the specified time period (Maximum Waiting Time), the numeric entry will cancel the data entry operation.						
	Maximum Waiting Time	Specifies the maximum time that the numeric entry will wait for the operator's confirmation. The data entry will be cancelled if the operator does not respond within this time.						
Operation Logging	Operation Logging	Check this option so the following three items will be recorded in the operation log when the numeric entry outputs the entered value. There are three recorded items: 1) The time when the operation is performed 2) The entered value 3) The predefined operation message						
	Message	Enter the operation message of the first language here.						
		Click this button to bring up the Operation Message dialog box that you can edit the operation message for all the languages.						
Minimum Hold Time		Available when the object is a button or switch. The touch operation of the button will not be activated until the button is pressed and held down for the specified time period (Minimum Hold Time).						



#### 4.4.6. Visibility Settings

In the Visibility page of an object's property sheet, you can define how to show and hide that object. You can also modify the position and size of an object with the Visibility page.

The following are examples of the Visibility page:

The option "Controlled by Bit" is checked	The option "Controlled by User Level" is checked

The following table describes each property in the Visibility page.

Property		Description
Invisible		Check this option so the object will be invisible always. <b>Note:</b> The touch operation is still enabled with this setting.
Controlled by Bit	Controlled by Bit	Check this option so the object will be shown and hidden by the specified bit.
	Control Bit	Specifies the bit that will show or hide the object. Click  to enter the bit address. Click  to enter the bit tag.
	Visible State	Specifies the state (On or Off) that makes the object visible.
Controlled by User Level	Controlled by User Level	Check this option so the object will be shown and hidden by the current user level.
	Lowest Visible User Level	Specifies the lowest user level that is required to show the object.
Dimension	Left	Specifies the X coordinate of the object's upper-left corner on the screen.
	Top	Specifies the Y coordinate of the object's upper-left corner on the screen.
	Width	Specifies the width (in pixels) of the object.
	Height	Specifies the height (in pixels) of the object.
		Click this button to redraw the object with the new settings.



## CHAPTER 5

# BUTTONS AND SWITCHES

<b>5.1. Changing Bit State Using Bit Buttons .....</b>	<b>1</b>
5.1.1. Basic Operations.....	1
5.1.2. Operation Options.....	2
5.1.3. Settings.....	3
5.1.4. General Settings .....	4
<b>5.2. Toggling Bit State Using Toggle Switches.....</b>	<b>6</b>
5.2.1. Settings.....	6
5.2.2. General Settings .....	7
<b>5.3. Changing Screen Using Screen Buttons .....</b>	<b>9</b>
5.3.1. Basic Operations.....	9
5.3.2. Operation Options.....	9
5.3.3. Settings.....	10
5.3.4. General Settings .....	11
<b>5.4. Performing Built-in Function Using Function Buttons .....</b>	<b>14</b>
5.4.1. Basic Operations.....	14
5.4.2. Operation Options.....	17
5.4.3. Settings.....	18
5.4.4. General Settings .....	19
<b>5.5. Selecting Word Value Using Slide Switches.....</b>	<b>21</b>
5.5.1. Basic Operations.....	21
5.5.2. Operation Options.....	22
5.5.3. Settings.....	22
5.5.4. General Settings .....	23
<b>5.6. Setting Word Value Using Word Buttons .....</b>	<b>25</b>
5.6.1. Basic Operations.....	25
5.6.2. Operation Options.....	25
5.6.3. Settings.....	26
5.6.4. General Settings .....	26

<b>5.7. Selecting Work Value Using Multi-state Switches.....</b>	<b>28</b>
5.7.1. Basic Operations.....	28
5.7.2. Operation Options.....	29
5.7.3. Settings.....	29
5.7.4. General Settings.....	30
<b>5.8. Setting Word State Using Radio Button Groups .....</b>	<b>32</b>
5.8.1. Basic Operations.....	32
5.8.2. Operation Options.....	32
5.8.3. Settings.....	32
5.8.4. General Settings.....	33
<b>5.9. Customizing Keypad Using Keypad Buttons.....</b>	<b>35</b>
5.9.1. Basic Operations.....	35
5.9.2. Operation Options.....	35
5.9.3. Settings.....	35
5.9.4. General Settings.....	36
<b>5.10. Scrolling Object Content Using Scroll Button Groups .....</b>	<b>38</b>
5.10.1. Basic Operations.....	38
5.10.2. Operation Options.....	39
5.10.3. Settings.....	39
5.10.4. General Settings.....	40
<b>5.11. Scrolling Object Content Using Scroll Bars .....</b>	<b>41</b>
5.11.1. Basic Operations.....	41
5.11.2. Operation Options.....	42
5.11.3. Settings.....	42
5.11.4. General Settings.....	43
<b>5.12. Stepping Through Word State Using Step Buttons.....</b>	<b>44</b>
5.12.1. Basic Operations.....	44
5.12.2. Operation Options.....	44
5.12.3. Settings.....	45
5.12.4. General Settings.....	45
<b>5.13. Displaying Window Screen as Information Page Using Page     Selectors.....</b>	<b>48</b>
5.13.1. Basic Operations.....	48
5.13.2. Settings.....	48
5.13.3. General Settings.....	49



## 5.1. Changing Bit State Using Bit Buttons

You can touch a bit button to change the state of the specified bit.

### 5.1.1. Basic Operations

A bit button can be configured to perform the following operations:

Operation	Description
Set ON	Sets the specified bit to On when the button is pressed.
Set OFF	Sets the specified bit to Off when the button is pressed.
Set ON Pulse	Sets the specified bit to On when the button is pressed and then sets the bit to Off to generate a positive pulse with the specified pulse width.
Set OFF Pulse	Sets the specified bit to Off when the button is pressed and then sets the bit to On to generate a negative pulse with the specified pulse width.
Momentary ON	Sets the specified bit to On when the button is pressed and sets the bit to Off when the button is released. Note: Pressing and releasing a momentary button quickly might generate a pulse that is too short to be detected by the controller. To avoid this problem, specify a sufficient minimum pulse width for the operation so the setting of the bit to Off is delayed if necessary to generate a pulse that is always detectable.
Momentary OFF	Sets the specified bit to Off when the button is pressed and sets the bit to On when the button is released. Note: See the note above.
Invert	Inverts the state of the specified bit when the button is pressed.

**Note:** You can configure a bit button to operate a bit of a word or a bit of a double-word. In these cases, you need to specify the number of the bit to be operated.



### 5.1.2. Operation Options

The following operation options can be selected for a bit button to make it more informative, secure, and useful. You need to select and set those options in the Bit Button property sheet.

Option	Description																								
Monitor	The bit button can be configured to monitor a bit. When this option is selected, the state of the button is controlled by the monitored bit. With the monitored bit, you can control the color and label of the bit button.																								
ON Macro, OFF Macro	<p>An ON Macro is a macro that is run when the associated button is activated to set a bit to 1 (On). An OFF Macro, on the contrary, is a macro that is run when the associated button is activated to set a bit to 0 (Off). The following table shows the macros that each bit button operations can support.</p> <table border="1"> <thead> <tr> <th>Operation</th> <th>ON Macro</th> <th>OFF Macro</th> </tr> </thead> <tbody> <tr> <td>Set ON</td> <td>•</td> <td></td> </tr> <tr> <td>Set OFF</td> <td></td> <td>•</td> </tr> <tr> <td>Set ON Pulse</td> <td>•</td> <td></td> </tr> <tr> <td>Set OFF Pulse</td> <td></td> <td>•</td> </tr> <tr> <td>Momentary ON</td> <td>•</td> <td>•</td> </tr> <tr> <td>Momentary OFF</td> <td>•</td> <td>•</td> </tr> <tr> <td>Invert</td> <td></td> <td></td> </tr> </tbody> </table> <p>Select these options in the General Page. Specify and edit the ON macro in the ON Macro page. Specify and edit the OFF macro in the OFF Macro page.</p> <p><b>Note:</b> When an ON macro or OFF macro is specified, the associated bit setting operation is not performed until the macro is completely executed. So it is important to keep ON and OFF macros as short as possible in order not to delay the bit setting operation.</p>	Operation	ON Macro	OFF Macro	Set ON	•		Set OFF		•	Set ON Pulse	•		Set OFF Pulse		•	Momentary ON	•	•	Momentary OFF	•	•	Invert		
Operation	ON Macro	OFF Macro																							
Set ON	•																								
Set OFF		•																							
Set ON Pulse	•																								
Set OFF Pulse		•																							
Momentary ON	•	•																							
Momentary OFF	•	•																							
Invert																									
Touch Operation Control	The touch operation can be enabled or disabled either by a specified bit or by the current user level. Select and set this option in the Advanced page.																								
Minimum Hold Time	The touch operation of the button will not be activated until the button is pressed and held down for the specified time period (Minimum Hold Time). Set this option in the Advanced page.																								
Operator Confirmation	<p>This option is available for the following bit button operations: Set ON, Set OFF, Set ON Pulse, Set OFF Pulse, and Invert.</p> <p>The Confirmation box will display when the button is touched. If the operator selects “Yes” in the Confirmation box, the button will proceed to perform its operation. If the operator selects “No” or the operator does not respond within the specified time period (Maximum Waiting Time), the button will stop performing its operation.</p> <p>Select and set this option in the Advanced page.</p>																								
Notification	The button can be configured to notify a bit of the completion of the bit setting operation when the button is pressed. Select and set this option in the Advanced page.																								
Operation Logging	Each touch operation of the button can be recorded in the operation log. Select and set this option in the Advanced page.																								
Invisible	The button can be invisible and still touch operable. Select this option in the Visibility page.																								
Visibility Control	The button can be shown or hidden either by a specified bit or by the current user level. Select and set this option in the Visibility page.																								



### 5.1.3. Settings

You can complete all the settings of a bit button in the Bit Button property sheet. This sheet contains the following seven pages. Some of the pages appear only when they are needed.

- **General**

Described in [Section 5.1.4.](#)

- **Label**

Described in [Section 4.3.5.](#)

- **Advanced**

Described in [Section 4.4.5.](#)

- **Visibility**

Described in [Section 4.4.6.](#)

- **External Label**

Described in [Section 4.3.8.](#)

- **On Macro**

Described in [Section 14.2.6.](#)

- **OFF Macro**

Described in [Section 14.2.6.](#)



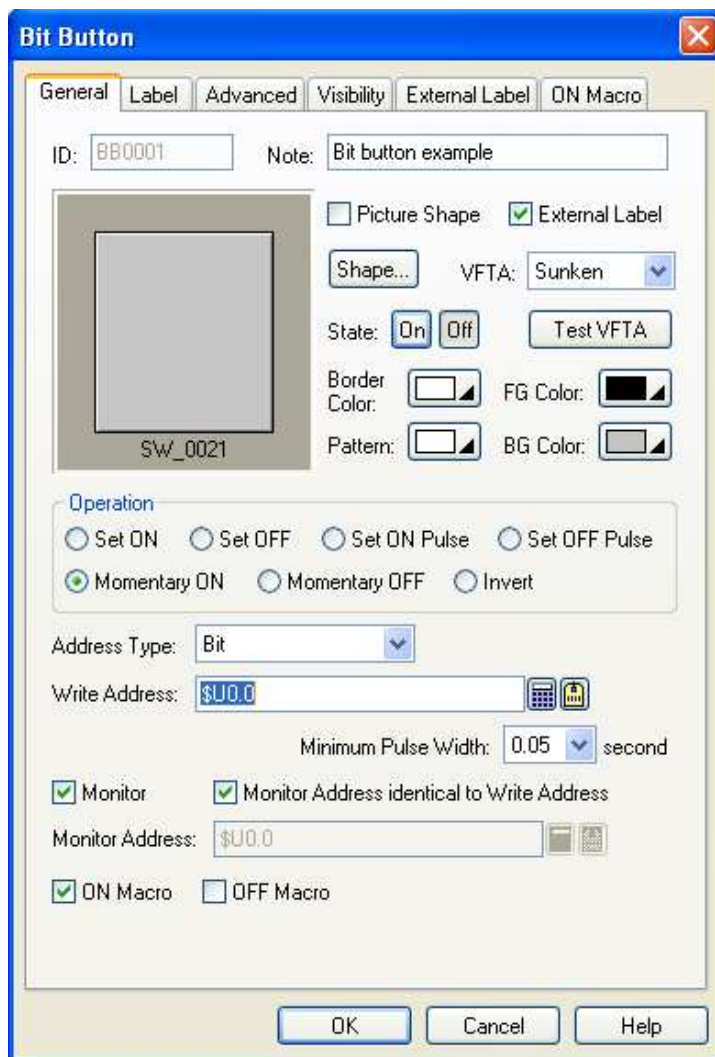

### 5.1.4. General Settings

This section describes how to define the general settings for the bit buttons in the General page of the Bit Button property sheet. The following is an example of the General page.



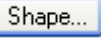
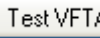



The following table describes each property in the General page.

Property	Description
ID	The object's identifier. It is generated when the object is created. The identifier is unique within the screen where the object is on. The format of the ID's for the bit buttons is BBnnnn.
Note	You can type a note for the bit button.
Shape settings	For details about the following properties, see <a href="#">Section 4.3.4 Setting up the Shape of an Object</a> . Picture Shape,  , VFTA,  , Border Color, Pattern, FG Color, BG Color
External Label	Check this option if you want the bit button to have an external label. Set up the external label in the External Label page.
	Click this button to change the object state to 1 (On) so you can view and set the object appearance for state 1 (On).
	Click this button to change the object state to 0 (Off) so you can view and set the object appearance for state 0 (Off).

Continued



Property		Description								
Operation		Select the operation for the bit button. There are 7 choices: Set ON, Set OFF, Set ON Pulse, Set OFF Pulse, Momentary ON, Momentary OFF, and Invert. For details, see <a href="#">Section 5.1.1 Basic Operations</a>								
Write Address	Address Type	Specifies the type of variable in the Write Address field. The bit buttons support the following three variable types:								
		<table border="1"> <thead> <tr> <th>Variable Type</th> <th>Description</th> </tr> </thead> <tbody> <tr> <td>Bit</td> <td>The variable is a bit variable.</td> </tr> <tr> <td>Word</td> <td>The variable is a word variable. You need to specify which bit of the word variable that is to be operated. Specify the bit number (0~15) in the Bit Number field.</td> </tr> <tr> <td>Double-word</td> <td>The variable is a double-word variable. You need to specify which bit of the double-word variable that is to be operated. Specify the bit number (0~31) in the Bit Number field.</td> </tr> </tbody> </table>	Variable Type	Description	Bit	The variable is a bit variable.	Word	The variable is a word variable. You need to specify which bit of the word variable that is to be operated. Specify the bit number (0~15) in the Bit Number field.	Double-word	The variable is a double-word variable. You need to specify which bit of the double-word variable that is to be operated. Specify the bit number (0~31) in the Bit Number field.
		Variable Type	Description							
		Bit	The variable is a bit variable.							
	Word	The variable is a word variable. You need to specify which bit of the word variable that is to be operated. Specify the bit number (0~15) in the Bit Number field.								
	Double-word	The variable is a double-word variable. You need to specify which bit of the double-word variable that is to be operated. Specify the bit number (0~31) in the Bit Number field.								
Write Address	Specifies the bit variable to be operated when the Address Type is Bit. Specifies the word variable that contains the bit to be operated when the Address Type is Word. Specifies the double-word variable that contains the bit to be operated when the Address Type is Double-word.									
	Click this icon to bring up the Address Input Keypad and specify the desired address for the Write Address field.									
	Click this icon to bring up the Select Tag dialog box and select the desired tag for the Write Address field.									
	Bit Number	Specifies which bit of the variable specified in Write Address field is to be operated.								
Minimum Pulse Width		The minimum width of the pulse that the Momentary ON and Momentary OFF operations must generate. There are six choices available: 0.05, 0.1, 0.2, 0.3, 0.4, and 0.5 second.								
Pulse Width		The width of the pulse generated by the Set ON Pulse and Set OFF Pulse operations. There are six choices available: 0.05, 0.1, 0.2, 0.3, 0.4, and 0.5 second.								
Monitor		Check this option if you want the bit button to monitor a specified bit and display its state.								
Monitor Address identical to Write Address		Specifies that the Monitor Address is identical to the Write Address. With this item checked, you don't need to specify the Monitor Address again. This item is available when the option Monitor is checked.								
Monitor Address	Monitor Address	Specifies the bit variable to be monitored when the Address Type is Bit. Specifies the word variable that contains the bit to be monitored when the Address Type is Word. Specifies the double-word variable that contains the bit to be monitored when the Address Type is Double-word.								
			Click this icon to bring up the Address Input Keypad and specify the desired address for the Monitor Address field.							
		Click this icon to bring up the Select Tag dialog box and select the desired tag for the Monitor Address field.								
ON Macro		Check this option if you want the button to have an ON macro. Specify and edit the ON macro in the ON Macro page. This option is available when the bit button operation is Set ON, Set ON Pulse, Momentary ON, or Momentary OFF.								
OFF Macro		Check this option if you want the button to have an OFF macro. Specify and edit the OFF macro in the OFF Macro page. This option is available when the bit button operation is Set OFF, Set OFF Pulse, Momentary ON, or Momentary OFF.								
Key		The hard key that is used to operate the bit button. This item is available only when the target panel has hard keys.								



## 5.2. Toggling Bit State Using Toggle Switches

You can touch a toggle switch to toggle the state of the specified bit.

The difference between a toggle switch and a bit button performing Invert operation is described below:

- 1) A toggle switch performs the toggle operation by writing the inverse state of the monitored bit to the destination bit.
- 2) A bit button performs the Invert operation by inverting the destination bit directly regardless of the monitored bit.

### 5.2.1. Settings

You can complete all the settings of a toggle switch in the Toggle Switch property sheet. This sheet contains the following seven pages. Some of the pages appear only when they are needed.

- **General**

Described in [Section 5.2.2.](#)

- **Label**

Described in [Section 4.3.5.](#)

- **Advanced**

Described in [Section 4.4.5.](#)

- **Visibility**

Described in [Section 4.4.6.](#)

- **External Label**

Described in [Section 4.3.8.](#)

- **On Macro**

Described in [Section 14.2.6.](#)

- **OFF Macro**

Described in [Section 14.2.6.](#)

### 5.2.2. General Settings

This section describes how to define the general settings for a toggle switch.

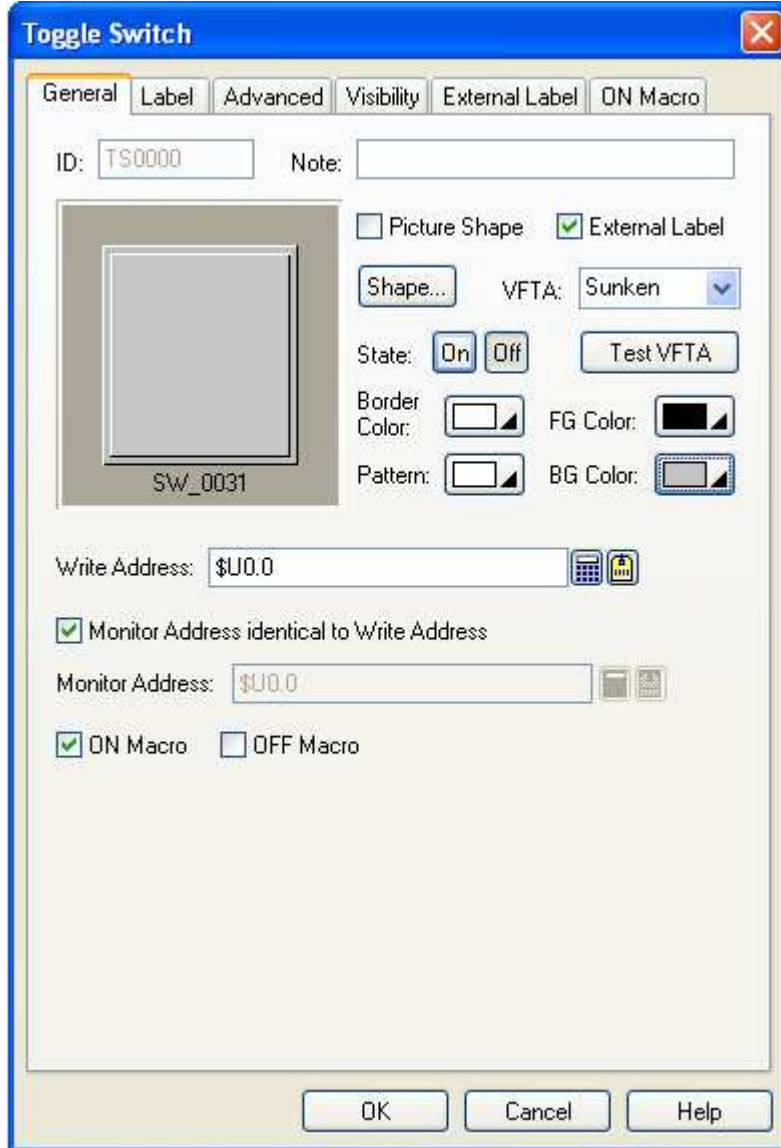







The above is an example of the General page of the Toggle Switch property sheet.

The following table describes each property in the General page.

Property	Description
ID	The object's identifier. It is generated when the object is created. The identifier is unique within the screen where the object is on. The format of the ID's for toggle switches is TSnnnn.
Note	You can type a note for the object.
Shape settings	For details about the following properties, see <a href="#">Section 4.3.4 Setting up the Shape of an Object.</a> Picture Shape, <input type="button" value="Shape..."/> , VFTA, <input type="button" value="Test VFTA"/> , Border Color, Pattern, FG Color, BG Color
External Label	Check this option if you want the object to have an external label. Set up the external label in the External Label page.

Continued



Property		Description
		Click this button to change the object state to 1 (On) so you can view and set the object appearance for state 1 (On).
		Click this button to change the object state to 0 (Off) so you can view and set the object appearance for state 0 (Off).
Write Address	Write Address	Specifies the bit variable to be operated.
		Click this icon to bring up the Address Input Keypad and specify a bit address for the Write Address field.
		Click this icon to bring up the Select Tag dialog box and select a bit tag for the Write Address field.
Monitor Address identical to Write Address		Specifies that the Monitor Address is identical to the Write Address. With this item checked, you don't need to specify the Monitor Address again. This item is available when the option Monitor is checked.
Monitor Address	Monitor Address	Specifies the bit variable to be monitored.
		Click this icon to bring up the Address Input Keypad and specify a bit address for the Monitor Address field.
		Click this icon to bring up the Select Tag dialog box and select a bit tag for the Monitor Address field.
ON Macro		Check this option if you want the button to have an ON macro. Specify and edit the ON macro in the ON Macro page.
OFF Macro		Check this option if you want the button to have an OFF macro. Specify and edit the OFF macro in the OFF Macro page.
Key		The hard key that is used to operate the object. This item is available only when the target panel has hard keys.



## 5.3. Changing Screen Using Screen Buttons

You can touch a screen button to open or close a screen.

### 5.3.1. Basic Operations

A screen button can be configured to perform one of the following screen switching operations:

Operation	Description
Open Screen	Opens the specified screen.
Previous Screen	Closes the current main screen and opens the previous main screen. Note: The panel can display many window screens but only one normal screen at a time so a normal screen is also called a main screen. The panel can remember up to 32 previously opened main screens.
Close & Open Screen	Closes the window screen where the screen button is on and opens the specified screen.
Close Screen	Closes the window screen where the screen button is on.

### 5.3.2. Operation Options

The following operation options can be selected for a screen button to make it more informative, secure, and useful. You need to select and set those options in the Screen Button property sheet.

Options	Description
Change User Level	The button can be configured to change the current user level.
Acknowledge Alarm	The button can be configured to acknowledge the associated alarm of the screen where it is on. You can configure an alarm to display an (alarm) screen and the associated alarm of a screen is the alarm that displays the screen.
Indicate Screen Already Opened	The button can be configured to indicate that the specified screen is opened. The indication is done by exchanging the button's FG color with its text color.
Macro	You can specify a macro that will be run when the screen button is activated to perform its operation. Select this option in the General page. Specify and edit the macro in the Macro page. Note: The screen switching operation will not be performed until the macro is completely executed. So it is important to keep the macro as short as possible to not delay the operation.
Touch Operation Control	The touch operation can be enabled or disabled either by a specified bit or by the current user level. Select and set this option in the Advanced page.
Minimum Hold Time	The touch operation of the button will not be activated until the button is pressed and held down for the specified time period (Minimum Hold Time). Select and set this option in the Advanced page.
Notification	The screen button can be configured to notify a bit of the completion of the screen switching operation. Select and set this option in the Advanced page.
Operation Logging	Each touch operation of the button can be recorded in the operation log. Select and set this option in the Advanced page.
Invisible	The button can be invisible and still touch operable. Select this option in the Visibility page.
Visibility Control	The button can be shown or hidden either by a specified bit or by the current user level. Select and set this option in the Visibility page.



### 5.3.3. Settings

You can complete all the settings of a screen button in the Screen Button property sheet. This sheet contains the following six pages. Some of the pages appear only when they are needed.

- **General**

Described in [Section 5.3.4.](#)

- **Label**

Described in [Section 4.3.5.](#)

- **Advanced**

Described in [Section 4.4.5.](#)

- **Visibility**

Described in [Section 4.4.6.](#)

- **External Label**

Described in [Section 4.3.8.](#)

- **Macro**

Described in [Section 14.2.6.](#)

### 5.3.4. General Settings

This section describes how to define the general settings for a screen button.

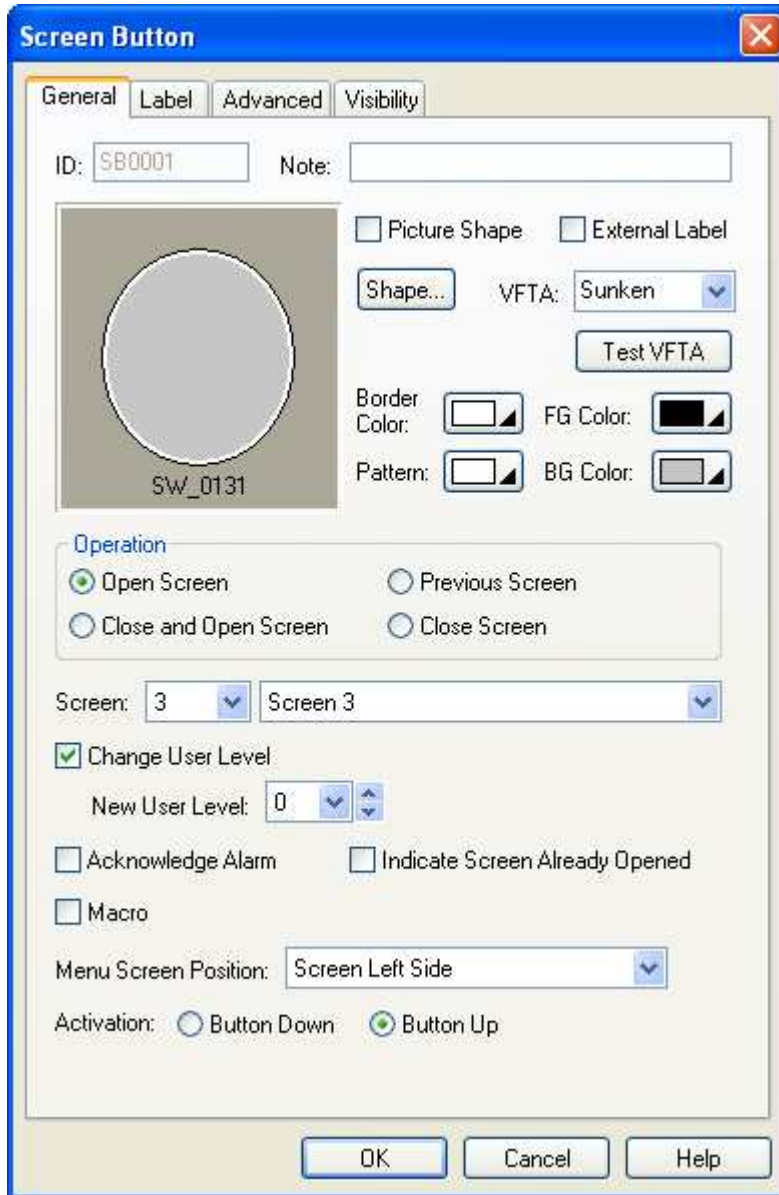



The above is an example of the General page of the Screen Button dialog box.



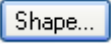

The following table describes each property in the General page.

Property		Description
ID		The object's identifier. It is generated when the object is created. The identifier is unique within the screen where the object is on and is unchangeable. The format of the ID's for screen buttons is SB####.
Note		You can type a note for the object.
Shape settings		For details about the following properties, see <a href="#">Section 4.3.4 Setting up the Shape of an Object</a> . Picture Shape,  , VFTA,  , Border Color, Pattern, FG Color, BG Color
External Label		Check this option if you want the object to have an external label. Set up the external label in the External Label page.
Operation		Specifies the operation that you want the screen button to perform. There are four choices: Open Screen, Previous Screen, Close and Open Screen, and Close Screen. For details, see <a href="#">Section 5.3.1 Basic Operations</a> .
Screen		Specifies the screen to be opened.
Change User Level	<Check Box>	Check this option if you want the button to change the current user level.
	New User Level	The new user level to replace the current user level.
Acknowledge Alarm		Check this option if you want the button to acknowledge the associated alarm of the screen where the button is on.
Indicate Screen Already Opened		Check this option if you want the button to indicate the specified screen is already open.
Macro		Check this option if you want the button to have a macro. Specify and edit the macro in the Macro page.
Activation	Button Down	Specifies that the touch operation is activated when the button is pushed.
	Button Up	Specifies that the touch operation is activated when the button is released.
Key		The hard key that is used to operate the object. This item is available only when the target panel has hard keys.

Continued

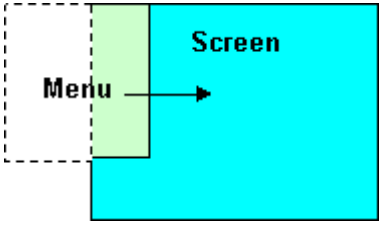
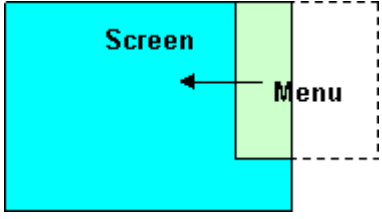
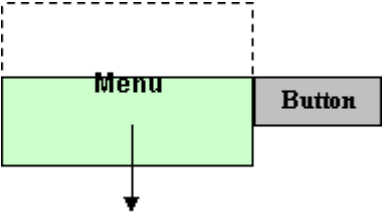
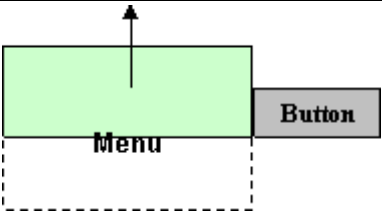
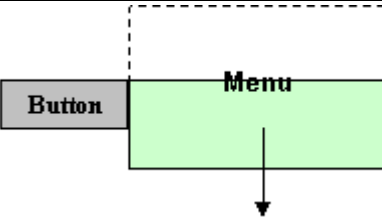
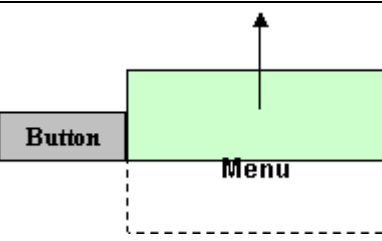

Property	Description	
Menu Screen Position	Select one of the following 6 positions for the specified menu screen to show up. This field will be showed up only when the specified screen is a menu screen.	
	Position	Description
	Screen Left Side	The menu screen slides into the view horizontally from the left side of the screen. 
	Screen Right Side	The menu screen slides into the view horizontally from the right side of the screen. 
	Button Left Side & Downward	The menu screen appears by the left side of the button and slides downward into the view. 
	Button Left Side & Upward	The menu screen appears by the left side of the button and slides upward into the view. 
	Button Right Side & Downward	The menu screen appears by the right side of the button and slides downward into the view. 
	Button Right Side & Upward	The menu screen appears by the right side of the button and slides upward into the view. 



## 5.4. Performing Built-in Function Using Function Buttons

You can touch a function button to perform the specified built-in function provided by the target panel.

### 5.4.1. Basic Operations

Category	Operation	Description											
Setting up Panel	Increase Brightness/Contrast	Increases either the brightness or the contrast of the display depending on the MT model. Not all MT models support this operation. Check the hardware manual for details.											
	Decrease Brightness/Contrast	Decreases either the brightness or the contrast of the display depending on the MT model. Not all MT models support this operation. Check the hardware manual for details.											
	Save Brightness/Contrast	Saves the setting of either the brightness or the contrast of the display depending on the MT model. Not all MT models support this operation. Check the hardware manual for details.											
	Enter Panel Setup Mode	Exits the application and enters the panel setup mode.											
	End Transparent Communication	Ends the transparent communication.											
	Show Real Time Clock	Displays the settings of Real Time Clock so you can change the settings.											
	Turn Backlight Off	Turns off the backlight of the display. To turn on the backlight, touch the screen. Not all MT models support this operation. Check the hardware manual for details.											
Setting up Application	Log In	Displays the password keypad so you can enter a password to change the current user level.											
	Log Out	Changes the current user level to 0.											
	Show Password Table	Displays the password table so you can change the passwords. The password table only lists the passwords whose user level is equal to or less than the current user level.											
	Acknowledge Alarm	Acknowledges the associated alarm of the screen that the button is on.											
	Change Language	Change the current language to the specified language.											
	Show File Selection Box	<p>Displays the File Selection box for the specified purpose. The following table lists the five purposes:</p> <table border="1"> <thead> <tr> <th>Purpose</th> <th>Description</th> </tr> </thead> <tbody> <tr> <td>Open to Read</td> <td>Open the specified file for reading. The file must exist. (Note)</td> </tr> <tr> <td>Open/create to Write</td> <td>Open the specified file for reading. A new file is created when the specified file does not exist. If the specified file exists, it will be over written. (Note)</td> </tr> <tr> <td>Open/create to Append</td> <td>Open the specified file for appending data. A new file is created when the specified file does not exist. (Note)</td> </tr> <tr> <td>Delete</td> <td>Delete the specified file.</td> </tr> <tr> <td>Rename</td> <td>Rename the specified file.</td> </tr> </tbody> </table> <p>You can specify the File Extension Name that will limit the File Selection Box to list only the files of the specified type. The specified extension name can only have ASCII characters and at most 3 characters.</p> <p><b>Note:</b> You need to specify the File I/O Control Block Address which is an internal variable that receives the result of the file open operation. You can specify a macro that will be run when the specified file is opened successfully. It is important to close an opened file by the macro command CLOSE_FILE when you finish the operation on it, or the file data will be lost.</p>	Purpose	Description	Open to Read	Open the specified file for reading. The file must exist. (Note)	Open/create to Write	Open the specified file for reading. A new file is created when the specified file does not exist. If the specified file exists, it will be over written. (Note)	Open/create to Append	Open the specified file for appending data. A new file is created when the specified file does not exist. (Note)	Delete	Delete the specified file.	Rename
Purpose	Description												
Open to Read	Open the specified file for reading. The file must exist. (Note)												
Open/create to Write	Open the specified file for reading. A new file is created when the specified file does not exist. If the specified file exists, it will be over written. (Note)												
Open/create to Append	Open the specified file for appending data. A new file is created when the specified file does not exist. (Note)												
Delete	Delete the specified file.												
Rename	Rename the specified file.												

Continued



Category	Operation	Description
Saving Data to File	Save Recipe Data (.txt file)	Saves the data of the specified recipe block in a text file. The file can be read by any text editor, Microsoft Excel, and the target panel.
	Save Recipe Data (.prd file)	Saves the data of the specified recipe block in a file using the PRD format. The file can be read by the RecipeEditor and the target panel.
	Save Logged Data (.txt file)	Saves the data collected by the specified data logger in a text file. The file can be read by any text editor, Microsoft Excel, and the target panel.
	Save Logged Data (.ldf file)	Saves the data collected by the specified data logger in an LDF file. The file can be read by the target panel only.
	Save Alarm History (.txt file)	Saves the alarm history in a text file. The file can be read by any text editor, Microsoft Excel, and the target panel.
	Save Alarm Counts (.txt file)	Saves the alarm counts in a text file. The file can be read by any text editor, Microsoft Excel, and the target panel.
	Save Operation History (.txt file)	Saves the operation history in a text file. The file can be read by any text editor, Microsoft Excel, and the target panel.
	Save Line Chart Data (.txt file)	Saves the data collected by the specified line chart in a text file. The file can be read by any text editor, Microsoft Excel, and the target panel.
	Save Scatter Chart Data (.txt file)	Saves the data collected by the specified scatter chart in a text file. The file can be read by any text editor, Microsoft Excel, and the target panel.
	Save Application Configuration Data (.plf file)	Saves the application configuration data that was downloaded to the target panel before in a PLF file. The file can be used by PM Designer.
	Save System and Application to File (.prp file)	Saves the system programs and the application runtime data in a PRP file. The file can be used by PM Designer and compatible MT panels.
Loading Data from File	Load Recipe Data (.txt file)	Loads the data of the specified recipe block from a text file.
	Load Recipe Data (.prd file)	Loads the data of the specified recipe block from a PRD file.
	Load Logged Data (.ldf file)	Loads the data of the specified data logger from a LDF file.
	Load Line Chart Data (.txt file)	Loads the data of the specified line chart from a text file.
	Load Scatter Chart Data (.txt file)	Loads the data of the specified scatter chart from a text file.
Transferring Data	Write Recipe to Controller	Writes the current recipe, which is determined by the current recipe block and the current recipe number, to the specified controller. The controller and the destination address are specified in the settings of the recipe block.
	Read Recipe from Controller	Updates the current recipe, which is determined by the current recipe block and the current recipe number, by reading a recipe from the specified controller. The controller and the source address are specified in the settings of the recipe block.
	Save Recipe Data to Flash ROM	Saves the data of the specified recipe block to the target panel's flash ROM. The option "Need space in flash ROM to save backup" must be selected in the settings of the recipe block to make this operation available.
	Load Recipe Data from Flash ROM	Loads the data of the specified recipe block from the target panel's flash ROM. The option "Need space in flash ROM to save backup" must be selected in the settings of the recipe block to make this operation available.

Continued



Category	Operation	Description
Printing Screen	Print Screen	Prints the screen where the button is on. The printed area is specified in the settings of the screen properties.
	Print Screen to File (256-color .bmp)	Prints the screen where the button is on to a file with the BMP format of 256 colors. The printed area is specified in the settings of the screen properties.
	Print Screen to File (64K-color .bmp)	Prints the screen where the button is on to a file with the BMP format of 64K colors. The printed area is specified in the settings of the screen properties.
	Print Screen to File (True-color .bmp)	Prints the screen where the button is on to a file with the BMP format. The color resolution is the same as the target panel's display. The printed area is specified in the settings of the screen properties.
	Print Screen to File (.jpg)	Prints the screen where the button is on to a file with the JPG format. The printed area is specified in the settings of the screen properties.
Clearing Data	Clear Logged Data	Clears the data of the specified data logger.
	Clear Logged Data (All)	Clears the data of all the data loggers.
	Clear Alarm History	Clears the alarm history.
	Clear Alarm Counts	Resets the alarm counts to 0.
	Clear Operation History	Clears the operation history.
Running Application	Restart Application	Restarts the application.
	Update System and Application From File (.prp)	Updates the system programs and the application runtime data from a PRP file. The original system programs and the application runtime data are replaced by the new ones.
	Boot from File (.prp)	Load-and-runs the system programs and the application runtime data from a PRP file. The original system programs and runtime data are intact. The loaded system programs and the runtime data will be lost after power off.
Multimedia	Play Sound	Plays the specified sound file.
	Stop Playing Sound	Stops playing the current sound file
	Take Picture	Takes a picture from the specified USB camera.
Adjusting Viewing Range	Zoom In	Makes the viewing range of the associated object one half smaller so the object shows less content with more detail.
	Zoom Out	Makes the viewing range of the associated object twice larger so the object shows more content with less detail.
	Restore to Normal View	Restores the viewing range to the original setting.
Scrolling Content	Scroll Left	Scrolls the content displayed by the associated object to the left.
	Scroll Right	Scrolls the content displayed by the associated object to the right.
	Scroll Up	Scrolls the content displayed by the associated object to the top.
	Scroll Down	Scrolls the content displayed by the associated object to the bottom.
	Scroll Page Left	Scrolls the content displayed by the associated object to the left by one page.
	Scroll Page Right	Scrolls the content displayed by the associated object to the right by one page.
	Scroll Page Up	Scrolls the content displayed by the associated object to the top by one page.
	Scroll Page Down	Scrolls the content displayed by the associated object to the bottom by one page.
	Scroll to Left End	Scrolls the content displayed by the associated object to the left end.
	Scroll to Right End	Scrolls the content displayed by the associated object to the right end.
	Scroll to Bottom End	Scrolls the content displayed by the associated object to the bottom end.
	Scroll to Top End	Scrolls the content displayed by the associated object to the top end.

Continued



Category	Operation	Description
Changing Data	Select Next Data Entry Object	Selects the next data entry object on the screen where the button is on.
	Select Previous Data Entry Object	Selects the previous data entry object on the screen where the button is on.
	Increase Value by One	Activates the selected data entry object to set its specified variable to the value that is obtained by increasing the value of its monitored variable by one. The operation is available for multi-state buttons whose property "Activation" is set to "Indirect". The operation is available for numeric entries whose property "Data Entry" is set to "On-screen Keypad and/or Function Keys".
	Decrease Value by One	Activates the selected data entry object to set its specified variable to the value that is obtained by decreasing the value of its monitored variable by one. The operation is available for multi-state buttons whose property "Activation" is set to "Indirect". The operation is available for numeric entries whose property "Data Entry" is set to "On-screen Keypad and/or Function Keys".

### 5.4.2. Operation Options

The following operation options can be added to a function button to make it more informative, secure, and useful. You need to select and set these options in the Function Button property sheet.

Options	Description
Macro	You can specify a macro that will be run when a file is successfully opened. Select this option in the General page. Specify and edit the macro in the Macro page.
Touch Operation Control	The touch operation can be enabled and disabled either by a specified bit or by the current user level. Select and set this option in the Advanced page.
Minimum Hold Time	The touch operation of the button will not be activated until the button is pressed and held down for the specified time period (Minimum Hold Time). Set this option in the Advanced page.
Operator Confirmation	The Confirmation box will display when the button is touched. If the operator selects "Yes" in the Confirmation box, the button will proceed to perform its operation. If the operator selects "No" or the operator does not respond within the specified time period (Maximum Waiting Time), the button will stop performing its operation. Select and set this option in the Advanced page.
Notification	The button can be configured to notify a bit when the specified operation is performed successfully. Select and set this option in the Advanced page.
Operation Logging	Each touch operation of the button can be recorded in the operation log. Select and set this option in the Advanced page.
Invisible	The button can be invisible and still touch operable. Select this option in the Visibility page.
Visibility Control	The button can be shown or hidden either by a specified bit or by the current user level. Select and set this option in the Visibility page.



### 5.4.3. Settings

You can complete all the settings of a function button in the Function Button property sheet. This sheet contains the following five pages. Some of the pages appear only when they are needed.

- **General**

Described in [Section 5.4.4.](#)

- **Label**

Described in [Section 4.3.5.](#)

- **Advanced**

Described in [Section 4.4.5.](#)

- **Visibility**

Described in [Section 4.4.6.](#)

- **Macro**

Described in [Section 14.2.6.](#)

### 5.4.4. General Settings

This section describes how to define the general settings for a function button.

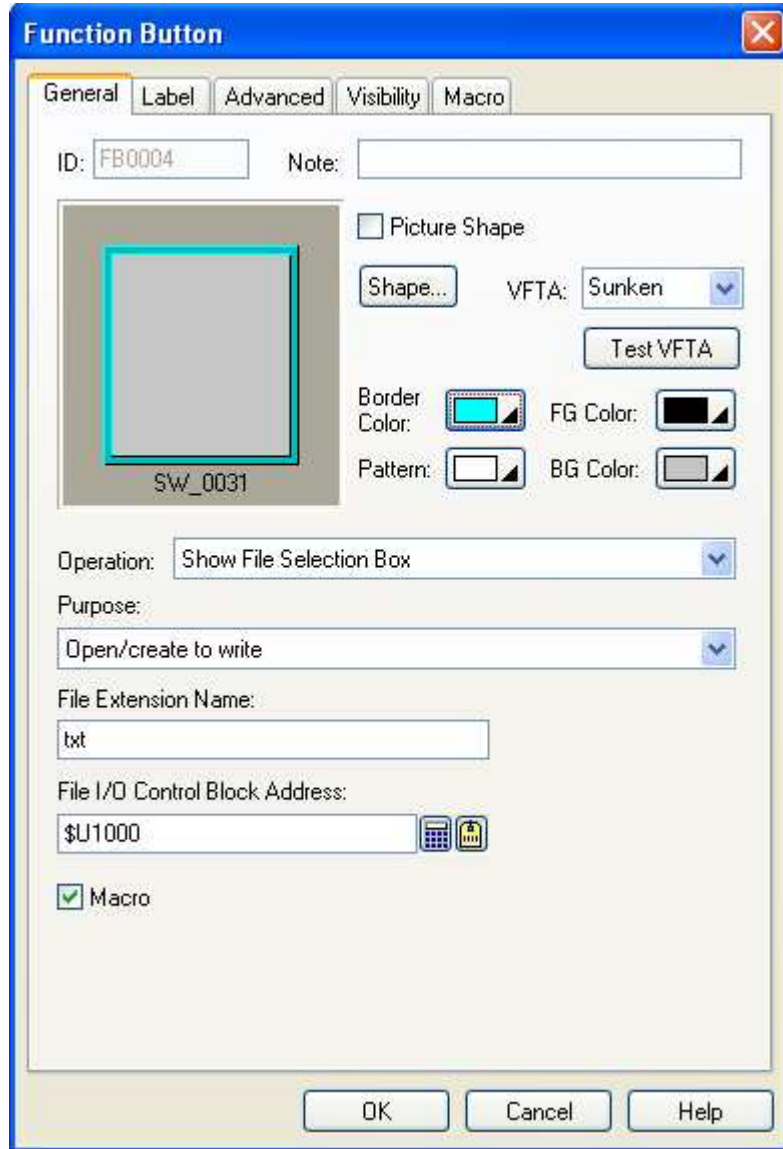

The above are an example of the General page of the Function Button dialog box.

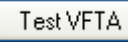

The following table describes each property in the General page.

Property	Description
ID	The object's identifier. It is generated when the object is created. The identifier is unique within the screen where the object is on. The format of the ID's for function buttons is FBnnnn.
Note	You can type a note for the object.
Shape settings	For details about the following properties, see <a href="#">Section 4.3.4 Setting up the Shape of an Object</a> . Picture Shape,  , VFTA,  , Border Color, Pattern, FG Color, BG Color

Continued





Property		Description	
External Label		Check this option if you want the object to have an external label. Set up the external label in the External Label page.	
Operation		Specifies the operation that you want the function button to perform. About the available operations, see <a href="#">Section 5.4.1 Basic Operation</a> .	
ID, Purpose, or Language	Associated Object ID	The ID of the object associated with the selected operation.	
	Data Logger	The ID of the data logger associated with the selected operation.	
	Line Chart	The ID of the line chart associated with the selected operation.	
	Recipe Block	The ID of the recipe block associated with the selected operation.	
	Scatter Chart	The ID of the scatter chart associated with the selected operation.	
	Purpose	The purpose for the Show File Selection Box operation.	
	Language	The language for the Change Language operation.	
	Sound	The ID of the sound for the Play Sound operation.	
	Camera ID & Picture Type	The camera ID and the picture file type for the Take Picture operation.	
Filename, Extension name, Method	Default Filename	The default filename for the selected operation. The name can only have ASCII characters and at most 80 characters.	
	File Extension Name	The file extension name for the selected operation. The name can only have ASCII characters and at most 3 characters.	
	Method	The method for the Play Sound operation.	
Filename Selectable		Check this item so the File Selection box will display for the operator to select a file. The selected file will be used for the selected operation.	
File I/O Control Block Address	<Edit Box>	Specifies the internal variable to receive the result of the file open operation. The memory block requires 44 words.	
		<b>Word</b>	<b>Description</b>
		0,1	A 32-bit word to store the handle of an opened file
		2,3	A 32-bit word to store the size (in byte) of the file
	4~43	A byte array to store the filename and the extension name of the opened file; the maximum length of the filename and the extension name is 80 characters	
		Click this icon to bring up the Address Input Keypad and specify an internal address for this property.	
		Click this icon to bring up the Select Tag dialog box and select an internal tag for this property.	
Macro		Check this option if you want the button to have a macro. Specify and edit the macro in the Macro page.	
Key		The hard key that is used to operate the object. This item is available only when the target panel has hard keys.	



## 5.5. Selecting Word Value Using Slide Switches

You can touch the knob of a slide switch and move the knob to select a desired value. The selected value is written to the specified variable when you release the knob.

### 5.5.1. Basic Operations

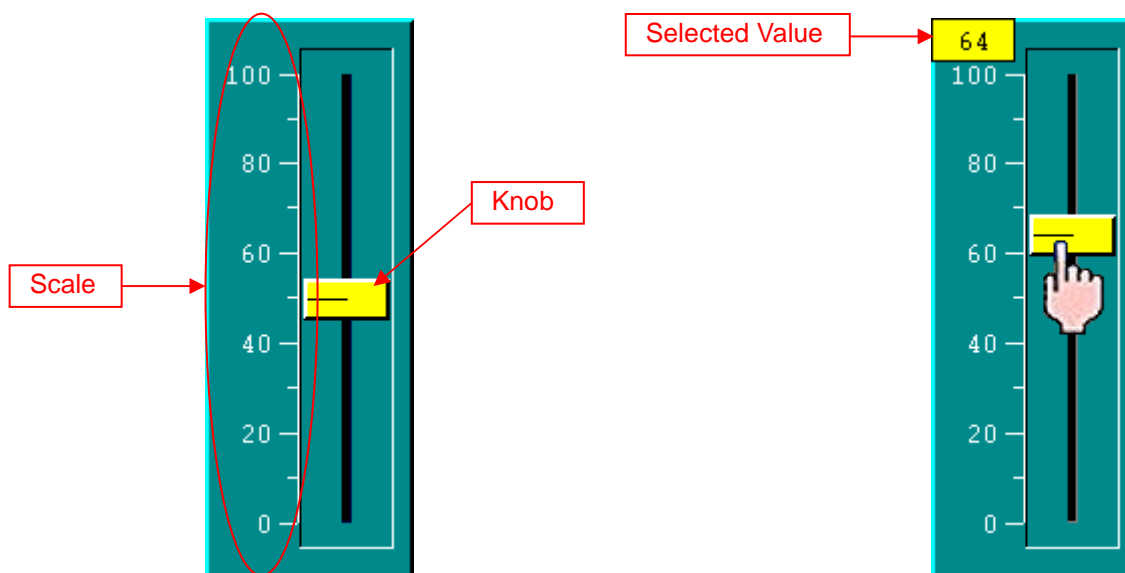

The above are two examples of slide switches. The right one shows a slide switch whose knob is being touched.

You specify the variable to be controlled, the minimum of the variable, and the maximum of the variable for a slide switch. The variable is monitored and its value combined with the specified minimum and maximum determines the knob position of the slide switch. You can touch and move the knob to select a desired value. The selected value is shown when the knob is being held. When you release the knob, the selected value is written to the specified variable.

You can choose one of the following four directions for a slide switch:

Direction	Description
Upward	The knob can move vertically. The knob is at the top end when the variable value is equal to or greater than the specified maximum. The knob is at the bottom end when the variable value is equal to or less than the specified minimum. When the variable value is between the maximum and minimum, the knob is at a proportional position between the top end and the bottom end.
Downward	The knob can move vertically. The knob is at the bottom end when the variable value is equal to or greater than the specified maximum. The knob is at the top end when the variable value is equal to or less than the specified minimum. When the variable value is between the maximum and minimum, the knob is at a proportional position between the bottom end and the top end.
Leftward	The knob can move horizontally. The knob is at the left end when the variable value is equal to or greater than the specified maximum. The knob is at the right end when the variable value is equal to or less than the specified minimum. When the variable value is between the maximum and minimum, the knob is at a proportional position between the left end and the right end.
Rightward	The knob can move horizontally. The knob is at the right end when the variable value is equal to or greater than the specified maximum. The knob is at the left end when the variable value is equal to or less than the specified minimum. When the variable value is between the maximum and minimum, the knob is at a proportional position between the right end and the left end.



### 5.5.2. Operation Options

The following operation options can be added to a slide switch to make it more informative, secure, and useful. You need to select and set these options in the Slide Switch dialog box.

Options	Description
Scale	The switch can have a scale. Select and set this option in the Scale page.
Touch Operation Control	The touch operation can be enabled and disabled either by a specified bit or by the current user level. Select and set this option in the Advanced page.
Notification	The switch can be configured to notify a bit when a change to the specified variable is performed. Select and set this option in the Advanced page.
Operation Logging	Each change to the specified variable can be recorded in the operation log. Select and set this option in the Advanced page.
Visibility Control	The switch can be shown or hidden either by a specified bit or by the current user level. Select and set this option in the Visibility page.

### 5.5.3. Settings

You can complete all the settings of a slide switch in the Slide Switch dialog box. This dialog box contains the following five pages. Some of the pages appear only when they are needed.

- **General**

Described in [Section 5.5.4.](#)

- **Scale**

Described in [Section 4.4.4.](#)

- **Advanced**

Described in [Section 4.4.5.](#)

- **Visibility**

Described in [Section 4.4.6.](#)

- **External Label**

Described in [Section 4.3.8.](#)

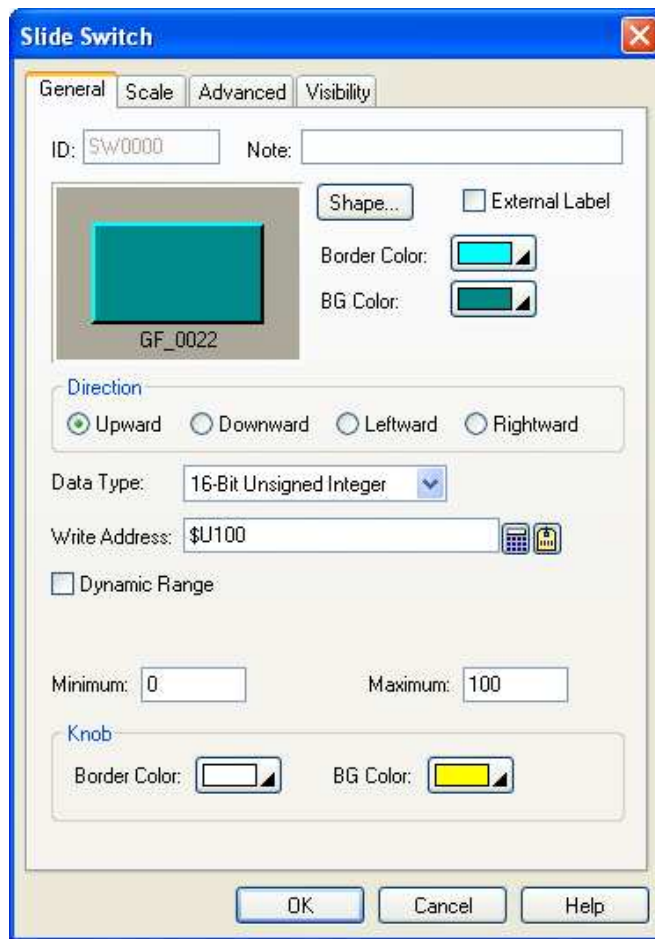

### 5.5.4. General Settings

This section describes how to define the general settings for a slide switch.





The above is an example of the General page of the Slide Switch dialog box.

The following table describes each property in the General page.

Property		Description
ID		The object's identifier. It is generated when the object is created. The identifier is unique within the screen where the object is on. The format of the ID's for slide switches is SWnnnn.
Note		You can type a note for the object.
Shape settings		For details about the following properties, see <a href="#">Section 4.3.4 Setting up the Shape of an Object</a> .  , Border Color, BG Color
External Label		Check this option if you want the object to have an external label. Set up the external label in the External Label page.
Direction		Specifies the direction of the slide switch. For details, <a href="#">see 5.5.1 Basic Operation</a> .
Data Type		The data type of the variable to be controlled by the object.
Write Address	Write Address	Specifies the variable to be controlled by the object.
		Click this icon to bring up the Address Input Keypad and specify an address for this field.
		Click this icon to bring up the Select Tag dialog box and select a tag for this field.

Continued



Property		Description																															
Dynamic Range	Dynamic Range	Check this option so the minimum and the maximum of the variable will be specified at runtime. When this option is selected, the minimum and maximum of the marks for the scale of the slide switch can be specified at runtime too. The data that specifies the above two ranges should be set and arranged correctly in a memory block called the dynamic range parameter block. You need to specify the dynamic range parameter block for the slide switch in the Dynamic Range Parameter Block field.																															
	Dynamic Range Parameter Block	<p>Specifies the variable that stores the dynamic range parameter block for the slide switch when the Dynamic Range is selected.</p> <p>Click  to enter an address for this field. Click  to select a tag for this field.</p> <p>The following table shows the data arrangement of the parameter block when the data type is 16-bit and the scale of the slide switch is not dynamic.</p> <table border="1"> <thead> <tr> <th>Word</th> <th>Parameter</th> </tr> </thead> <tbody> <tr> <td>0</td> <td>The minimum of the variable</td> </tr> <tr> <td>1</td> <td>The maximum of the variable</td> </tr> </tbody> </table> <p>The following table shows the data arrangement of the parameter block when the data type is 16-bit and the scale of the slide switch is dynamic.</p> <table border="1"> <thead> <tr> <th>Word</th> <th>Parameter</th> </tr> </thead> <tbody> <tr> <td>0</td> <td>The minimum of the variable</td> </tr> <tr> <td>1</td> <td>The maximum of the variable</td> </tr> <tr> <td>2, 3</td> <td>The minimum of the mark for the scale; 32-bit integer number</td> </tr> <tr> <td>4, 5</td> <td>The maximum of the mark for the scale; 32-bit integer number</td> </tr> </tbody> </table> <p>The following table shows the data arrangement of the parameter block when the data type is 32-bit and the scale of the slide switch is not dynamic.</p> <table border="1"> <thead> <tr> <th>Word</th> <th>Parameter</th> </tr> </thead> <tbody> <tr> <td>0, 1</td> <td>The minimum of the variable</td> </tr> <tr> <td>2, 3</td> <td>The maximum of the variable</td> </tr> </tbody> </table> <p>The following table shows the data arrangement of the parameter block when the data type is 32-bit and the scale of the slide switch is dynamic.</p> <table border="1"> <thead> <tr> <th>Word</th> <th>Parameter</th> </tr> </thead> <tbody> <tr> <td>0, 1</td> <td>The minimum of the variable</td> </tr> <tr> <td>2, 3</td> <td>The maximum of the variable</td> </tr> <tr> <td>4, 5</td> <td>The minimum of the mark for the scale; 32-bit integer number</td> </tr> <tr> <td>6, 7</td> <td>The maximum of the mark for the scale; 32-bit integer number</td> </tr> </tbody> </table>	Word	Parameter	0	The minimum of the variable	1	The maximum of the variable	Word	Parameter	0	The minimum of the variable	1	The maximum of the variable	2, 3	The minimum of the mark for the scale; 32-bit integer number	4, 5	The maximum of the mark for the scale; 32-bit integer number	Word	Parameter	0, 1	The minimum of the variable	2, 3	The maximum of the variable	Word	Parameter	0, 1	The minimum of the variable	2, 3	The maximum of the variable	4, 5	The minimum of the mark for the scale; 32-bit integer number	6, 7
Word	Parameter																																
0	The minimum of the variable																																
1	The maximum of the variable																																
Word	Parameter																																
0	The minimum of the variable																																
1	The maximum of the variable																																
2, 3	The minimum of the mark for the scale; 32-bit integer number																																
4, 5	The maximum of the mark for the scale; 32-bit integer number																																
Word	Parameter																																
0, 1	The minimum of the variable																																
2, 3	The maximum of the variable																																
Word	Parameter																																
0, 1	The minimum of the variable																																
2, 3	The maximum of the variable																																
4, 5	The minimum of the mark for the scale; 32-bit integer number																																
6, 7	The maximum of the mark for the scale; 32-bit integer number																																
Minimum		The minimum of the variable to be controlled.																															
Maximum		The maximum of the variable to be controlled.																															
Knob	Border Color	The border color of the knob. To specify the color, click the corresponding Color icon and select a color from the Color palette.																															
	BG Color	The color inside the border. To specify the color, click the corresponding Color icon and select a color from the Color palette.																															



## 5.6. Setting Word Value Using Word Buttons

You can touch a word button to set a value to the specified variable.

### 5.6.1. Basic Operations

A word button can be configured to perform one of the following operations:

Operation	Description
Set Constant	Writes the specified constant to the specified variable.
Enter Value	Allows you to enter a value to change the specified variable. The Numeric Keypad displays when the button is pressed and released. After a value is entered with the keypad, the buttons checks if the value is within the range of the specified minimum and maximum. If the value is valid, the button writes the entered value to the specified variable. If the value is invalid, the operator has to enter another value or quit the operation.
Enter Password	Allows you to enter a value to change the specified variable. The keypad shows the input with a string of asterisk so others can not know the input value. The Numeric Keypad displays when the button is pressed and released. The keypad shows the operator input with a string of asterisk so others do not know the input value. After a value is entered with the keypad, the buttons checks if the value is within the range of the specified minimum and maximum. If the value is valid, the button writes the entered value to the specified variable. If the value is invalid, the operator has to enter another value or quit the operation.
Add	Increases the specified variable by the specified constant. If the result of the increase is greater than the specified maximum, the variable is set to the maximum.
Subtract	Decreases the specified variable by the specified constant. If the result of the decrease is less than the specified minimum, the variable is set to the minimum.

### 5.6.2. Operation Options

The following operation options can be added to a word button to make it more informative, secure, and useful. You need to select and set these options in the Word Button dialog box.

Options	Description
Touch Operation Control	The touch operation can be enabled or disabled either by a specified bit or by the current user level. Select and set this option in the Advanced page.
Minimum Hold Time	The touch operation of the button will not be activated until the button is pressed and held down for the specified time period (Minimum Hold Time). Set this option in the Advanced page.
Operator Confirmation	The Confirmation box will display when the button is touched. If the operator selects "Yes" in the Confirmation box, the button will proceed to perform its operation. If the operator selects "No" or the operator does not respond within the specified time period (Maximum Waiting Time), the button will stop performing its operation. Select and set this option in the Advanced page. Note that this option is not available for the Enter Password operation.
Notification	The button can be configured to notify a bit of the completion of the specified operation. Select and set this option in the Advanced page.
Operation Logging	Each touch operation of the button can be recorded in the operation log. Select and set this option in the Advanced page.
Invisible	The button can be invisible and still touch operable. Select this option in the Visibility page.
Visibility Control	The button can be shown or hidden either by a specified bit or by the current user level. Select and set this option in the Visibility page.

### 5.6.3. Settings

You can complete all the settings of a word button in the Word Button property sheet. This sheet contains the following five pages. Some of the pages appear only when they are needed.

- **General**

Described in [Section 5.6.4.](#)

- **Label**

Described in [Section 4.3.5.](#)

- **Advanced**

Described in [Section 4.4.5.](#)

- **Visibility**

Described in [Section 4.4.6.](#)

- **External Label**

Described in [Section 4.3.8.](#)

### 5.6.4. General Settings

This section describes how to define the general settings for a word button.

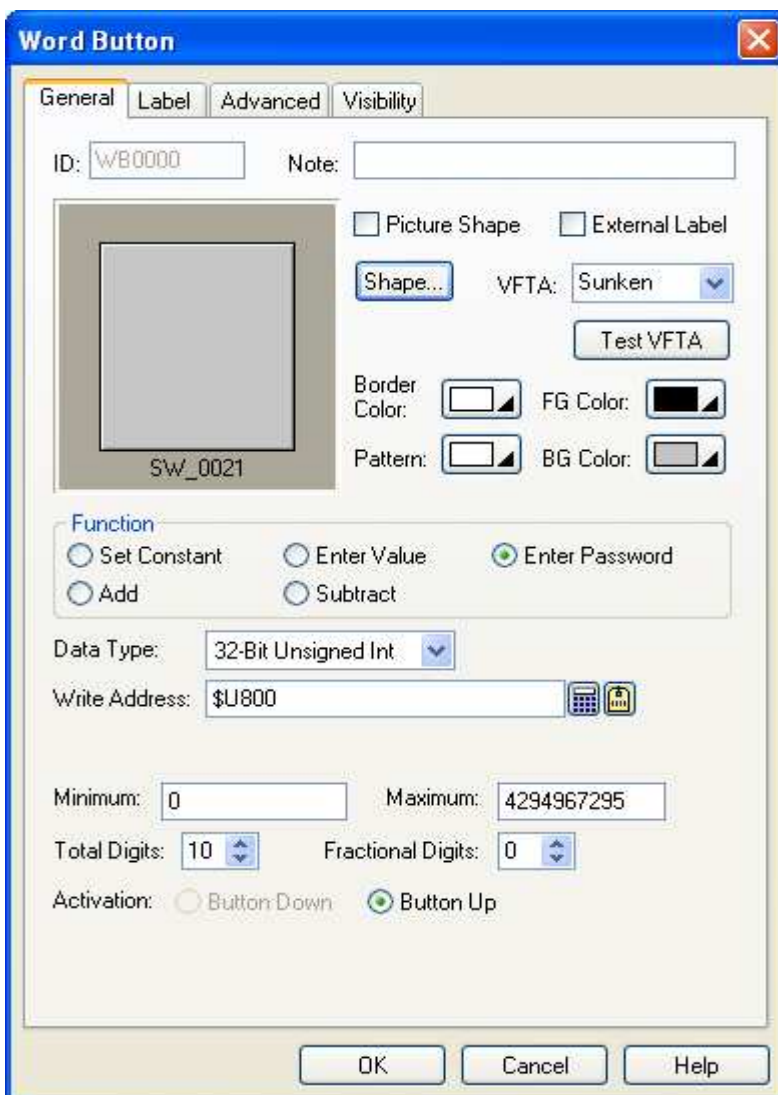





The above is an example of the General page of the Word Button property sheet.



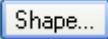

The following table describes each property in the General page.

Property		Description																														
ID		The object's identifier. It is generated when the object is created. The identifier is unique within the screen where the object is on. The format of the ID's for word buttons is WBnnnn.																														
Note		You can type a note for the word button.																														
Shape settings		For details about the following properties, see <a href="#">Section 4.3.4 Setting up the Shape of an Object</a> . Picture Shape,  , VFTA,  , Border Color, Pattern, FG Color, BG Color.																														
External Label		Check this option if you want the word button to have an external label. Set up the external label in the External Label page.																														
Operation		Specifies the operation that the word button performs. For details, <a href="#">see Section 5.6.1 Basic Operations</a> .																														
Data Type		The data type of the variable to be controlled.																														
Write Address	Write Address	Specifies the variable to be controlled.																														
		Click this icon to bring up the Address Input Keypad and specify an address for this property.																														
		Click this icon to bring up the Select Tag dialog box and select a tag for this property.																														
Constant		The constant for the specified operation.																														
Minimum		The minimum for the specified operation.																														
Maximum		The maximum for the specified operation.																														
Total Digits		The number of digits to be displayed for the Minimum and the Maximum on the numeric keypad.																														
Fractional Digits		<p>When the Data Type is 32-bit Floating Point, this property specifies the number of fractional digits to be displayed for the Minimum and the Maximum on the numeric keypad.</p> <p>When the Data Type is not 32-bit Floating Point, this property specifies not only the number of fractional digits to be displayed but also the number of least significant digits to be displayed as the fractional part. With this feature, an integer can be shown and entered as a fixed point number. When the Fractional Digits is nonzero, say N, the entered value will be converted to an integer according to the following formula before being output.</p> $\text{OutputValue} = \text{EnteredValue} * (\text{Nth power of } 10)$ <p><b>Example:</b></p> <table border="1"> <thead> <tr> <th>Display Type</th> <th>Total Digits</th> <th>Fractional Digits</th> <th>Entered Value</th> <th>Output Value</th> </tr> </thead> <tbody> <tr> <td>32-bit Floating Point</td> <td>4</td> <td>2</td> <td>12.34</td> <td>12.34</td> </tr> <tr> <td>32-bit Floating Point</td> <td>4</td> <td>2</td> <td>123.4</td> <td>Error!</td> </tr> <tr> <td>16-bit Signed Decimal</td> <td>5</td> <td>2</td> <td>123.45</td> <td>12345</td> </tr> <tr> <td>16-bit Signed Decimal</td> <td>5</td> <td>2</td> <td>-0.05</td> <td>-5</td> </tr> <tr> <td>16-bit Signed Decimal</td> <td>5</td> <td>2</td> <td>3</td> <td>300</td> </tr> </tbody> </table>	Display Type	Total Digits	Fractional Digits	Entered Value	Output Value	32-bit Floating Point	4	2	12.34	12.34	32-bit Floating Point	4	2	123.4	Error!	16-bit Signed Decimal	5	2	123.45	12345	16-bit Signed Decimal	5	2	-0.05	-5	16-bit Signed Decimal	5	2	3	300
Display Type	Total Digits	Fractional Digits	Entered Value	Output Value																												
32-bit Floating Point	4	2	12.34	12.34																												
32-bit Floating Point	4	2	123.4	Error!																												
16-bit Signed Decimal	5	2	123.45	12345																												
16-bit Signed Decimal	5	2	-0.05	-5																												
16-bit Signed Decimal	5	2	3	300																												
Activation	Button Down	Select this item so the touch operation will be activated when the button is touched.																														
	Button Up	Select this item so the touch operation will be activated when the button is released.																														
Key		The hard key that is used to operate the word button. This item is available when the target panel has hard keys.																														







## 5.7. Selecting Work Value Using Multi-state Switches

You can use a multi-state switch to change the state of the specified variable.

### 5.7.1. Basic Operations

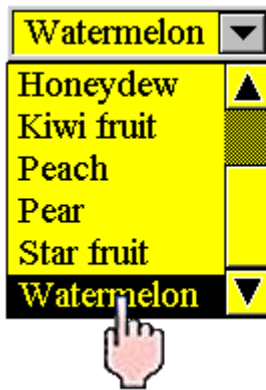
A multi-state switch can be configured to perform as one of the following types of controls:

Control Type	Description
Button	The multi-state switch is a push button. It changes the state of the specified variable to the next state when it is touched. Note that the next state is not necessarily the current state plus one.
List	<p>The multi-state switch is a list box. It lists the text of all the states of the switch one state per line starting from state 0 as shown in the right example.</p> <p>The text of the current state is highlighted. If the desired state is not in the view, you can use the scroll bar attached to the right side of the list box to scroll the text. When you select a desired state by touching its text, the list box writes the value of the selected state to the specified variable.</p> 
Drop-down List	<p>The multi-state switch is a drop-down list. It displays the text of the current state and a button with the down arrow symbol as shown in the following example.</p>  <p>When the button is touched, the switch list displays a list box beneath itself as shown in the following example.</p>  <p>The list box lists the text of all states of the switch one state per line starting from state 0. The text of the current state is highlighted. If the desired state is not in the view, you can use the scroll bar attached to the right side of the list to scroll the text. When you select a desired state by touching its text, the switch writes the value of the selected state to the specified variable and closes the list box.</p>   <p>If you want to cancel the operation when the list box is showing, touch anywhere other than the text in the list box.</p>

Continued



Control Type	Description
Throw-up List	

### 5.7.2. Operation Options

The following operation options can be added to a multi-state switch to make it more informative, secure, and useful. You need to select and set these options in the Multi-state Switch dialog box.

Options	Description
Touch Operation Control	The touch operation can be enabled and disabled either by a specified bit or by the current user level. Select and set this option in the Advanced page.
Minimum Hold Time	The touch operation of the switch will not be activated until the switch is pressed and held down for the specified time period (Minimum Hold Time). Set this option in the Advanced page.
Notification	The switch can be configured to notify a bit of the completion of the specified operation. Select and set this option in the Advanced page.
Operation Logging	Each data change performed by the switch can be recorded in the operation log. Select and set this option in the Advanced page.
Invisible	The switch can be invisible and still touch operable. Select this option in the Visibility page.
Visibility Control	The switch can be shown or hidden either by a specified bit or by the current user level. Select and set this option in the Visibility page.

### 5.7.3. Settings

You can complete all the settings of a multi-state switch in the Multi-state Switch dialog box. This dialog box contains the following six pages. Some of the pages appear only when they are needed.

- **General**

Described in [Section 5.7.4.](#)

- **Text**

Described in [Section 4.3.6.](#)

- **Picture**

Described in [Section 4.3.7.](#)

- **Advanced**

Described in [Section 4.4.5.](#)

- **Visibility**

Described in [Section 4.4.6.](#)

- **External Label**



Described in [Section 4.3.8.](#)

## 5.7.4. General Settings

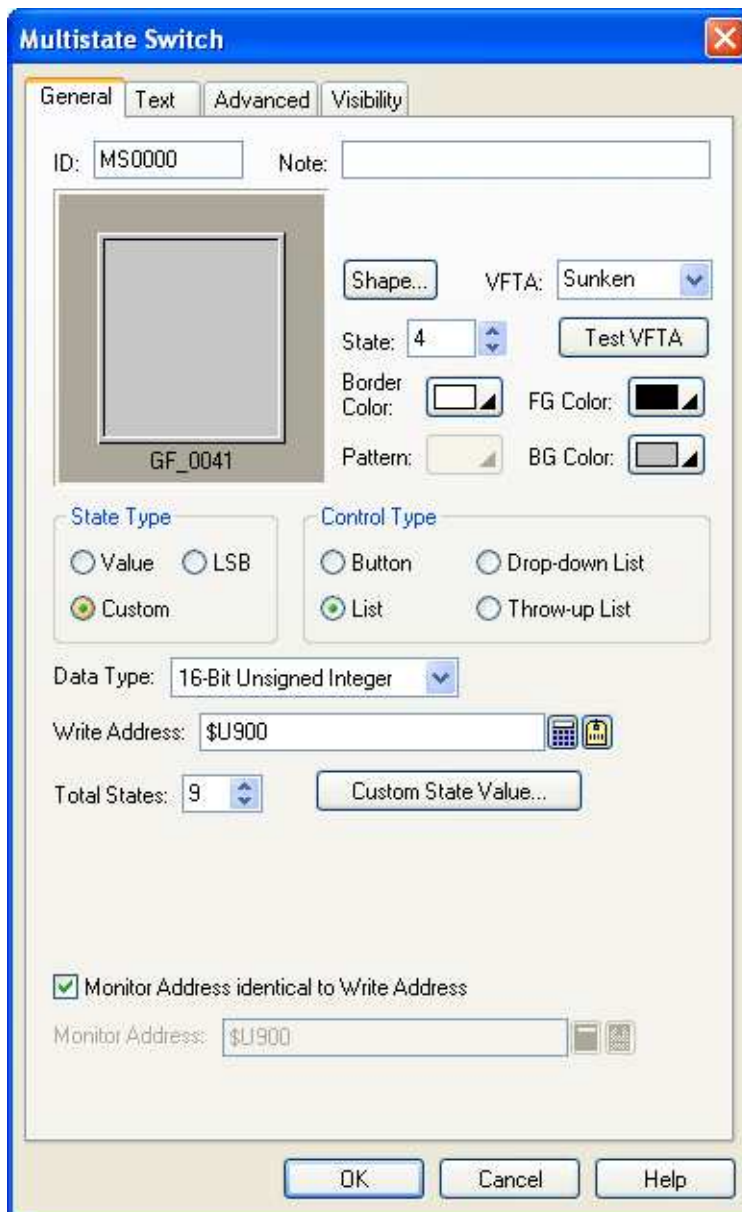
This section describes how to define the general settings for a multi-state switch. The following is an example of the General page of the Multi-state Switch property sheet.







The following table describes each property in the General page.

Property	Description
ID	The object's identifier. It is generated when the object is created. The identifier is unique within the screen where the object is on. The format of the ID's for multi-state switch is MSnnnn.
Note	You can type a note for the multi-state switch.
Shape settings	For details about the following properties, see <a href="#">Section 4.3.4 Setting up the Shape of an Object</a> . Picture Shape,  , VFTA,  , Border Color, Pattern, FG Color, BG Color
External Label	Check this option if you want the multi-state switch to have an external label. Set up the external label in the External Label page.

Continued



Property		Description
State		The current state of the multi-state switch that you can view and set the object appearance for.
State Type		The state type of the monitored variable. There are two options: Value and LSB. For details, see <a href="#">Section 4.4.1.1 State Types</a>
Control Type		Specifies the control type that the multi-state switch will perform as. There are three types you can choose: Button, List, and Drop-down List, Throw-up List. For details, see <a href="#">Section 5.7.1 Basic Operations</a>
Data Type		The data type of the variables specified in this page.
Write Address	Write Address	Specifies the variable to be controlled.
		Click this icon to bring up the Address Input Keypad and specify an address for this property.
		Click this icon to bring up the Select Tag dialog box and select a tag for this property.
Total States		Specifies the number of valid states that the monitored variable has. <b>Note:</b> The last state is state N-1 when the Total States is N.
Next State		Specifies the method of calculating the next state for the Button control type.
	+1 (Wrap)	The next state is the current state plus one when the current state is not the last state. When the current state is the last state, the next state is state 0.
	-1 (Wrap)	The next state is the current state minus one when the current state is not state 0. When the current state is state 0, the next state is the last state.
	+1/-1 (Retreat)	With this method, the switch is either in the increasing mode or in the decreasing mode for the next state calculation. The switch is in the increasing mode initially. Assume the total states of the switch is N. When the switch is in the increasing mode, the next state is the current state plus one if the current state is not the last state, i.e. state N-1. If the current state is the last state, the switch changes its mode to the decreasing mode and the next state is the current state minus one, i.e. state N-2. When the switch is in the decreasing mode, the next state is the current state minus one if the current state is not state 0. If the current state is state 0, the switch changes its mode to the increasing mode and the next state is the current state plus one, i.e. state 1.
Activation		Specifies how the multi-state switch is activated for the Button control type.
	Direct	The multi-state switch is activated when the button is touched.
	Indirect	The multi-state switch is activated when it is selected and a function button on the same screen with the operation of “Increase Value By One” or “Decrease Value y One” is touched.
Monitor Address identical to Write Address		Specifies that the Monitor Address is identical to the Write Address. With this item checked, you don't need to specify the same variable for the Monitor Address field.
Monitor Address	Monitor Address	Specifies the variable to be monitored.
		Click this icon to bring up the Address Input Keypad and specify an address for the Monitor Address field.
		Click this icon to bring up the Select Tag dialog box and select a tag for the Monitor Address field.
Key		The hard key that is used to operate the multi-state switch. This item is available when the target panel has hard keys.

## 5.8. Setting Word State Using Radio Button Groups

You can press a button of a radio button group to change the state of the controlled variable.

### 5.8.1. Basic Operations

A radio button group has as many radio buttons as the number of states it has. Each radio button corresponds to a state. When a radio button is pressed, the value of that button's associated state is written to the controlled variable. The state of a radio button group is determined by the state of the controlled variable. A radio button is highlighted when that button's associated state is the current state.

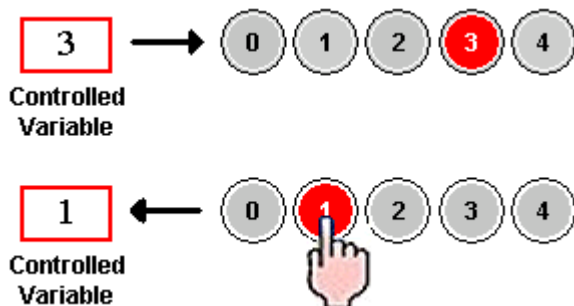

### 5.8.2. Operation Options

The following operation options can be added to a radio button group to make it more informative, secure, and useful. You need to select and set these options in the Radio Button Group dialog box.

Options	Description
Touch Operation Control	The touch operation of the radio button group can be enabled and disabled either by a specified bit or by the current user level. Select and set this option in the Advanced page.
Minimum Hold Time	The touch operation will not be activated until a button of the radio button group is pressed and held down for the specified time period (Minimum Hold Time). Set this option in the Advanced page.
Operation Logging	Each data change performed by the radio button group can be recorded in the operation log. Select and set this option in the Advanced page.
Visibility Control	The radio button group can be shown or hidden either by a specified bit or by the current user level. Select and set this option in the Visibility page.

### 5.8.3. Settings

You can complete all the settings of a radio button group in the Radio Button Group dialog box. This dialog box contains the following six pages. Some of the pages appear only when they are needed.

- **General**

Described in [Section 5.8.4.](#)

- **Text**

Described in [Section 4.3.6.](#)

- **Picture**

Described in [Section 4.3.7.](#)

- **Advanced**

Described in [Section 4.4.5.](#)

- **Visibility**

Described in [Section 4.4.6.](#)

- **External Label**



Described in [Section 4.3.8.](#)

### 5.8.4. General Settings

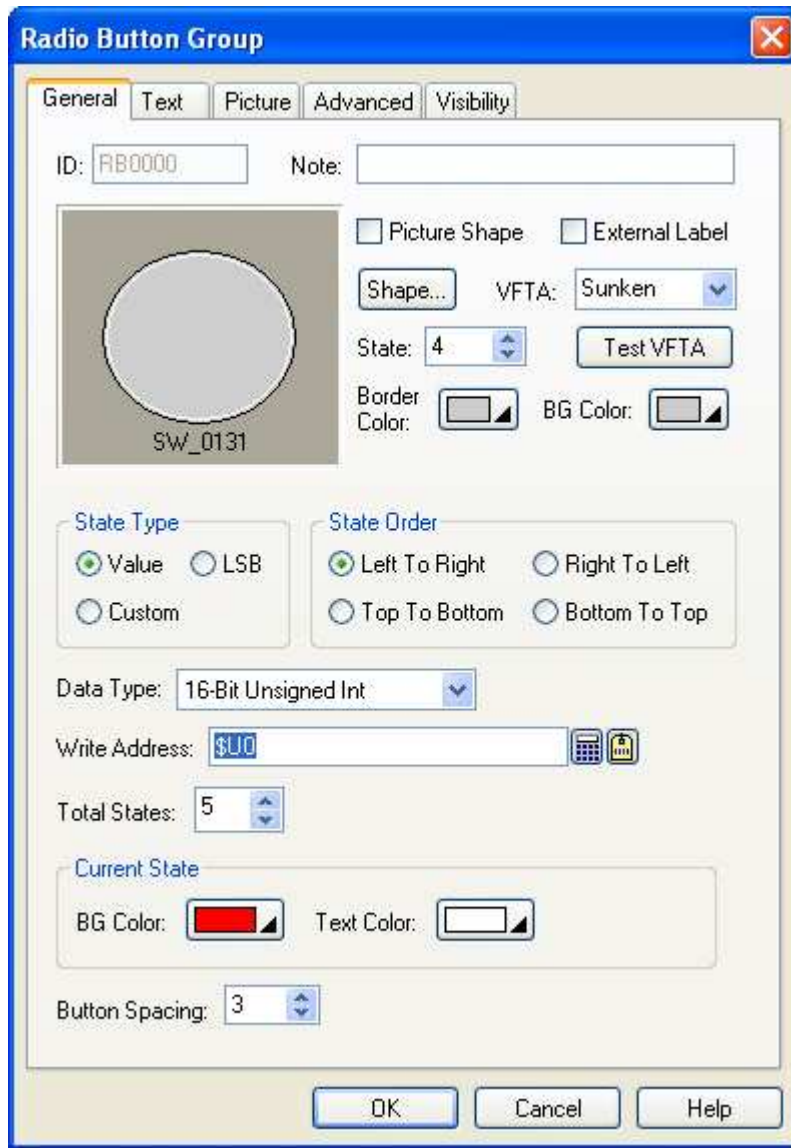
This section describes how to define the general settings for a radio button group. The following is an example of the General page of the Radio Button Group property sheet.





The following table describes each property in the General page.

Property	Description
ID	The object's identifier. It is generated when the object is created. The identifier is unique within the screen where the object is on. The format of the ID's for radio button groups is RBnnnn.
Note	You can type a note for the radio button group.
Shape settings	For details about the following properties, <a href="#">Section 4.3.4 Setting up the Shape of an Object</a> . Picture Shape,  , VFTA,  , Border Color, BG Color
External Label	Check this option if you want the radio button group to have an external label. Set up the external label in the External Label page.

Continued



Property		Description										
State		<p>Specifies the current state of the radio button group. You can set the appearance of the button associated with the current state.</p> <p><b>Note:</b> Although you can set the appearance for the button of the current state, you can not view all the changes right away. This is because the button is highlighted with the BG color and the text color set for the Current State. You can change the current state so the button is shown with new settings instead of being highlighted.</p>										
State Type		The state type of the controlled variable. There are three options: Value, LSB, and Custom. For details, see <a href="#">Section 4.4.1.1 State Types</a> .										
State Order		<p>Specifies how to arrange the radio buttons. There are four kinds of order:</p> <table border="1"> <thead> <tr> <th>State Order</th> <th>Description</th> </tr> </thead> <tbody> <tr> <td>Left To Right</td> <td>The buttons are arranged in a row orderly with the button of state 0 at the left most position.</td> </tr> <tr> <td>Right To Left</td> <td>The buttons are arranged in a row orderly with the button of state 0 at the right most position.</td> </tr> <tr> <td>Top To Bottom</td> <td>The buttons are arranged in a column orderly with the button of state 0 at the top position.</td> </tr> <tr> <td>Bottom To Top</td> <td>The buttons are arranged in a column orderly with the button of state 0 at the bottom position.</td> </tr> </tbody> </table>	State Order	Description	Left To Right	The buttons are arranged in a row orderly with the button of state 0 at the left most position.	Right To Left	The buttons are arranged in a row orderly with the button of state 0 at the right most position.	Top To Bottom	The buttons are arranged in a column orderly with the button of state 0 at the top position.	Bottom To Top	The buttons are arranged in a column orderly with the button of state 0 at the bottom position.
State Order	Description											
Left To Right	The buttons are arranged in a row orderly with the button of state 0 at the left most position.											
Right To Left	The buttons are arranged in a row orderly with the button of state 0 at the right most position.											
Top To Bottom	The buttons are arranged in a column orderly with the button of state 0 at the top position.											
Bottom To Top	The buttons are arranged in a column orderly with the button of state 0 at the bottom position.											
Data Type		The data type of the variables specified in this page.										
Write Address	Write Address	Specifies the variable to be controlled.										
		Click this icon to bring up the Address Input Keypad and specify an address for this property.										
		Click this icon to bring up the Select Tag dialog box and select a tag for this property.										
Total States		Specifies the number of valid states that the controlled variable has.										
Current State		The settings to highlight the button of the current state.										
	BG Color	The color to replace the shape's BG color for highlighting.										
	Text Color	The color to replace the text color for highlighting.										
Button Spacing		The distance in pixels between two adjacent radio buttons.										
Custom State Value		Click this button to define the state value for each state when the State Type is Custom. For details, see <a href="#">Section 4.4.1.2 Setting the Custom States of an Object</a> .										



## 5.9. Customizing Keypad Using Keypad Buttons

You can use keypad buttons to create your own keypads.

### 5.9.1. Basic Operations

A keypad button inputs a character to the keypad buffer or issues a command to the keypad buffer when it is pressed. You can create your own keypads as the custom keypads for your application. The following is a custom keypad.



### 5.9.2. Operation Options

The following operation options can be added to a keypad button to make it more useful. You need to select and set these options in the Keypad Button dialog box.

Options	Description
Macro	The keypad button can have a macro to execute when being pressed. Specify and edit the macro in the Macro page.
Visibility Control	The keypad button can be shown or hidden either by a specified bit or by the current user level. Select and set this option in the Visibility page.

### 5.9.3. Settings

You can complete all the settings of a keypad button in the Keypad Button dialog box. This dialog box contains the following four pages. Some of the pages appear only when they are needed.

- **General**  
Described in [Section 5.9.4.](#)
- **Label**  
Described in [Section 4.3.5.](#)
- **Visibility**  
Described in [Section 4.4.6.](#)
- **Macro**  
Described in [Section 14.2.6.](#)



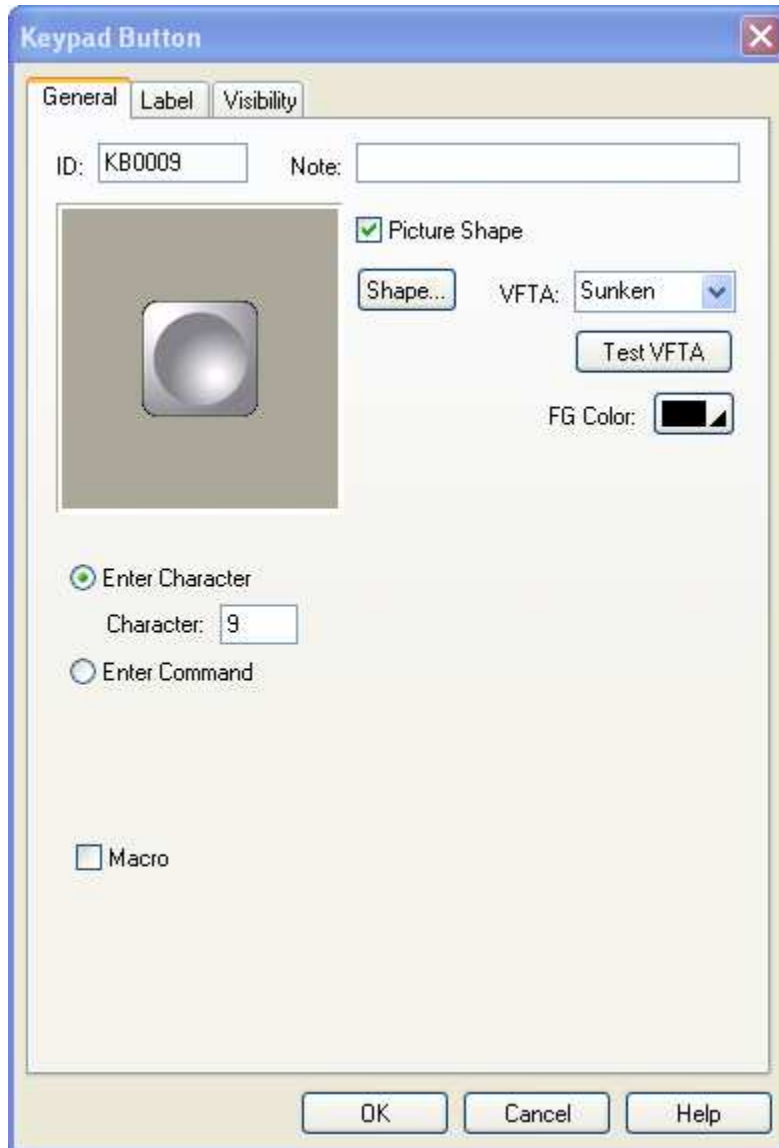

### 5.9.4. General Settings

This section describes how to define the general settings for a keypad button. The following is an example of the General page of the Keypad Button property sheet.



The following table describes each property in the General page.

Property	Description
ID	The object's identifier. It is generated when the object is created. The identifier is unique within the screen where the object is on. The format of the ID's for the keypad buttons is KBnnnn.
Note	You can type a note for the keypad button group.
Shape settings	For details about the following properties, see <a href="#">Section 4.3.4 Setting up the Shape of an Object</a> . Picture Shape,  , VFTA,  , Border Color, Pattern Color, FG Color, BG Color
Enter Character	Select this item if the button is used to input the specified character to the keypad buffer.
Character	Available when the Enter Character is selected. Specifies the character to be entered in the keypad buffer.

Continued









Property	Description										
Enter Command	Select this item if the button is used to issue the specified command to the keypad buffer.										
Command	Available when the Enter Command is selected. Specifies the command to be issued to the keypad buffer. There are four commands available: <table border="1" data-bbox="252 392 1497 638"> <thead> <tr> <th>Command</th> <th>Description</th> </tr> </thead> <tbody> <tr> <td>Enter</td> <td>Completes the data entry and sends the input string to the associated object or the system.</td> </tr> <tr> <td>Escape</td> <td>Cancels the data entry operation.</td> </tr> <tr> <td>Clear</td> <td>Clears the keypad buffer.</td> </tr> <tr> <td>Backspace</td> <td>Removes the last character in the keypad buffer.</td> </tr> </tbody> </table>	Command	Description	Enter	Completes the data entry and sends the input string to the associated object or the system.	Escape	Cancels the data entry operation.	Clear	Clears the keypad buffer.	Backspace	Removes the last character in the keypad buffer.
Command	Description										
Enter	Completes the data entry and sends the input string to the associated object or the system.										
Escape	Cancels the data entry operation.										
Clear	Clears the keypad buffer.										
Backspace	Removes the last character in the keypad buffer.										
Key	The hard key that is used to operate the keypad button. This item is available only when the target panel has hard keys.										
Macro	Check this option if you want the button to have a macro. Specify and edit the macro in the Macro page.										

## 5.10. Scrolling Object Content Using Scroll Button Groups







You can use buttons of a scroll button group to scroll the content displayed by the associated object.

### 5.10.1. Basic Operations

A scroll button group with the horizontal button alignment can have the following buttons:

Button	Example	Description
Scroll To Right End		Scrolls the content displayed by the associated object to the right end.
Scroll Page Right		Scrolls the content displayed by the associated object to the right by one page.
Scroll Right		Scrolls the content displayed by the associated object to the right.
Scroll Left		Scrolls the content displayed by the associated object to the left.
Scroll Page Left		Scrolls the content displayed by the associated object to the left by one page.
Scroll To Left End		Scrolls the content displayed by the associated object to the left end.
Pause		This is a toggle switch. It stops the auto-scrolling of the content displayed by the associated object when it is touched. When you touch it again, it resumes the auto-scrolling operation.

A scroll button group with the vertical button alignment can have the following buttons:

Button	Example	Description
Scroll To Top End		Scrolls the content displayed by the associated object to the top end.
Scroll Page Up		Scrolls the content displayed by the associated object to the top by one page.
Scroll Up		Scrolls the content displayed by the associated object to the top.
Scroll Down		Scrolls the content displayed by the associated object to the bottom.
Scroll Page Down		Scrolls the content displayed by the associated object to the bottom by one page.
Scroll To Bottom End		Scrolls the content displayed by the associated object to the bottom end.
Pause		This is a toggle switch. It stops the auto-scrolling of the content displayed by the associated object when it is touched. When you touch it again, it resumes the auto-scrolling operation.



### 5.10.2. Operation Options

The following operation option can be added to a scroll button group. You need to select and set this option in the Scroll Button Group dialog box.

Options	Description
Visibility Control	The scroll button group can be shown or hidden either by a specified bit or by the current user level. Select and set this option in the Visibility page.

### 5.10.3. Settings

You can complete all the settings of a scroll button group in the Scroll Button Group dialog box. This dialog box contains the following two pages.

- **General**

Described in [Section 5.10.4.](#)

- **Visibility**

Described in [Section 4.4.6.](#)

### 5.10.4. General Settings

This section describes how to define the general settings for a scroll button group. The following is an example of the General page of the Scroll Button Group property sheet.

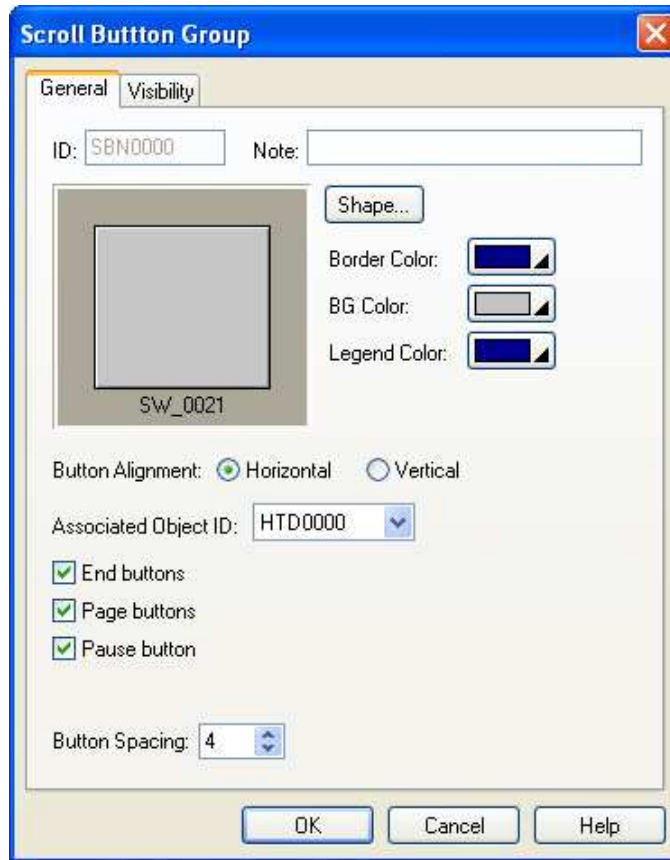

The following table describes each property in the General page.

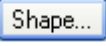
Property	Description	
ID	The object's identifier. It is generated when the object is created. The identifier is unique within the screen where the object is on. The format of the ID's for the scroll button groups is SBNnnnn.	
Note	You can type a note for the scroll button group.	
Shape settings	For details about the following properties, <a href="#">Section 4.3.4 Setting up the Shape of an Object</a> .  , Border Color, BG Color	
Legend Color	The color of the legend for every button of the scroll button group.	
Button Alignment	Horizontal	The buttons of the scroll button group are aligned in a row.
	Vertical	The buttons of the scroll button group are aligned in a column.
Associated Object ID	The ID of the object that you will use the scroll button group to scroll its content. You can select the associated object from this drop-down list which shows the ID's of the objects on the same screen that support the scroll operation.	
Start/End buttons	Check this item when you want the scroll button group to include the buttons that scroll the content to the start or to the end.	
Scroll Page buttons	Check this item when you want the scroll button group to include the buttons that scroll the content each time by one page.	
Pause button	Check this item when you want the scroll button group to include the Pause button.	
Button Spacing	The distance in pixels between two adjacent buttons.	



## 5.11. Scrolling Object Content Using Scroll Bars

You can use a scroll bar to scroll the content displayed by the associated object. The associated objects include Historic Data Display, Historic Message Display, Historic Trend Display, Operation Log Display, Alarm Display, Recipe Table, and Sub-link Table.

### 5.11.1. Basic Operations

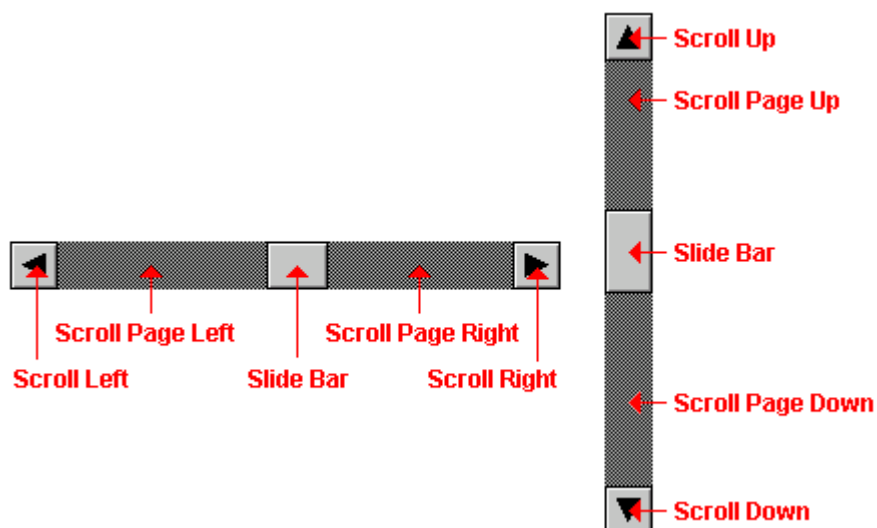

A horizontal scroll bar has the following buttons:

Button	Description
Scroll Right	Scrolls the content displayed by the associated object to the right.
Scroll Page Right	Scrolls the content displayed by the associated object to the right by one page.
Slide Bar	You can push and move the slide bar to scroll the content displayed by the associated object. The content is scrolled to the same direction as you move the slide bar. The amount of the scrolling is proportional to the displacement of the slide bar. The position of the slide bar in the scroll bar indicates the position of the viewable part of the content. The height of the slide bar indicates how much of the content is viewable.
Scroll Page Left	Scrolls the content displayed by the associated object to the left by one page.
Scroll Left	Scrolls the content displayed by the associated object to the left.

A vertical scroll bar has the following buttons:

Button	Description
Scroll Up	Scrolls the content displayed by the associated object to the top.
Scroll Page Up	Scrolls the content displayed by the associated object to the top by one page.
Slide Bar	You can push and move the slide bar to scroll the content displayed by the associated object. The content is scrolled to the same direction as you move the slide bar. The amount of the scrolling is proportional to the displacement of the slide bar. The position of the slide bar in the scroll bar indicates the position of the viewable part of the content. The width of the slide bar indicates how much of the content is viewable.
Scroll Page Down	Scrolls the content displayed by the associated object to the bottom by one page.
Scroll Down	Scrolls the content displayed by the associated object to the bottom.



### 5.11.2. Operation Options

The following operation option can be added to a scroll bar. You need to select and set this option in the Scroll Bar property sheet.

Options	Description
Visibility Control	The scroll bar can be shown or hidden either by a specified bit or by the current user level. Select and set this option in the Visibility page.

### 5.11.3. Settings

You can complete all the settings of a scroll bar in the Scroll Bar property sheet. This sheet contains the following two pages.

- **General**

Described in [Section 5.11.4.](#)

- **Visibility**

Described in [Section 4.4.6.](#)



### 5.11.4. General Settings

This section describes how to define the general settings for a scroll bar. The following is an example of the General page of the Scroll Bar property sheet.

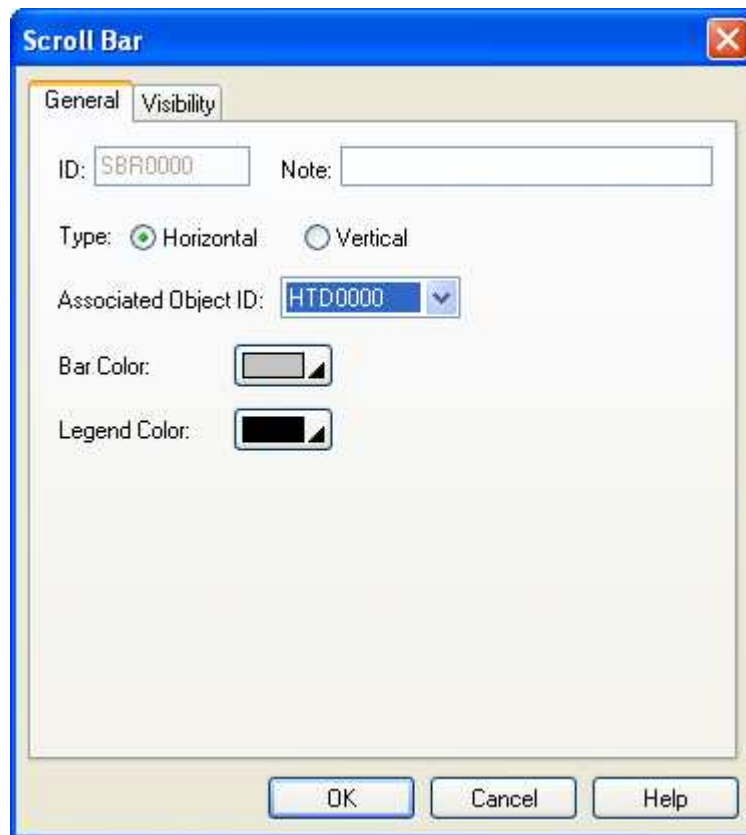

The following table describes each property in the General page.

Property	Description
ID	The object's identifier. It is generated when the object is created. The identifier is unique within the screen where the object is on. The format of the ID's for the scroll bars is SBRnnnn.
Note	You can type a note for the scroll button group.
Type	The type of the scroll bar. There are two types; horizontal and vertical.
Associated Object ID	The ID of the object that you will use the scroll bar to scroll its content. You can select the associated object from this drop-down list which shows the ID's of the objects on the same screen that support the scroll operation.
Bar Color	The color of the scroll bar.
Legend Color	The color of the legend for the buttons of the scroll bar.



## 5.12. Stepping Through Word State Using Step Buttons

You can press a step button to writes the value of the button's next state to the specified variable.

### 5.12.1. Basic Operations

Unlike most kinds of objects, a step button displays all the states at once with the current state highlighted instead of displaying just the current state. A step button can let the operators know all the available states and what the next state will be when they touch it.

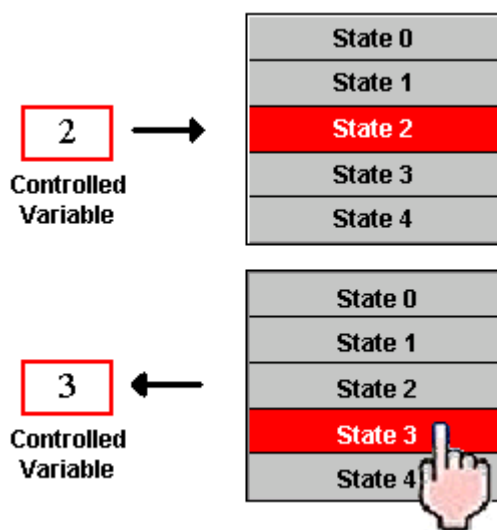

The state of a step button is determined by the value of the specified variable and the specified state type. When a step button is pressed, it calculates the value of the next state and writes that value to the specified variable. The next state is the current state plus one when the current state is not the last state. When the current state is the last state, the next state is state 0.

### 5.12.2. Operation Options

The following operation options can be added to a step button to make it more informative, secure, and useful. You need to select and set these options in the Step Button property sheet.

Options	Description
Touch Operation Control	The touch operation of the step button can be enabled and disabled either by a specified bit or by the current user level. Select and set this option in the Advanced page.
Minimum Hold Time	The touch operation will not be activated until the step button is pressed and held down for the specified time period (Minimum Hold Time). Set this option in the Advanced page.
Operation Logging	Each data change performed by the step button can be recorded in the operation log. Select and set this option in the Advanced page.
Visibility Control	The step button can be shown or hidden either by a specified bit or by the current user level. Select and set this option in the Visibility page.

### 5.12.3. Settings

You can complete all the settings of a step button in the Step Button property sheet. This sheet contains the following six pages. Some of the pages appear only when they are needed.

- **General**  
Described in [Section 5.12.4.](#)
- **Text**  
Described in [Section 4.3.6.](#)
- **Picture**  
Described in [Section 4.3.7.](#)
- **Advanced**  
Described in [Section 4.4.5.](#)
- **Visibility**  
Described in [Section 4.4.6.](#)
- **External Label**  
Described in [Section 4.3.8.](#)

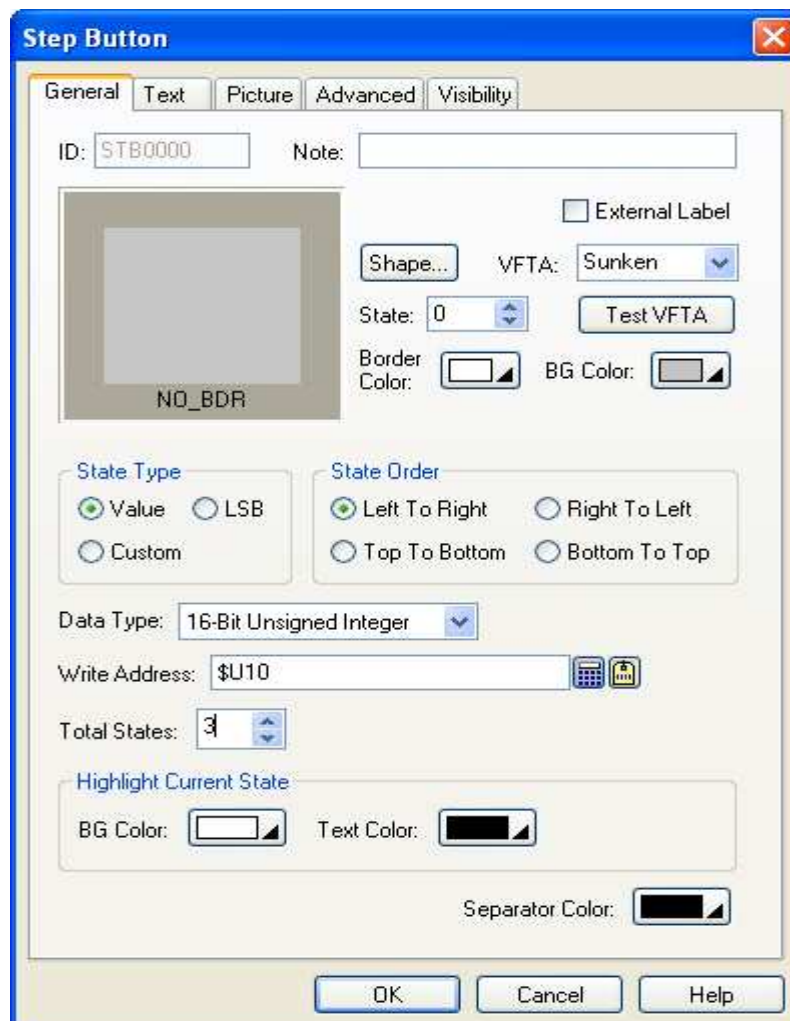

### 5.12.4. General Settings

This section describes how to define the general settings for a step button. The following is an example of the General page of the Step Button property sheet.





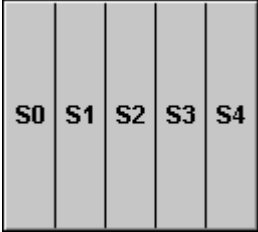
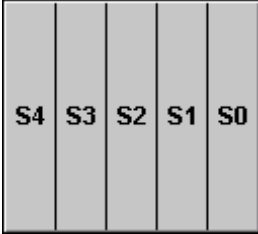
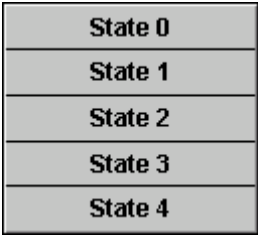
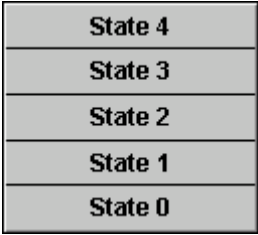
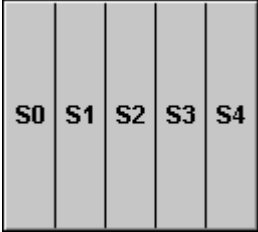
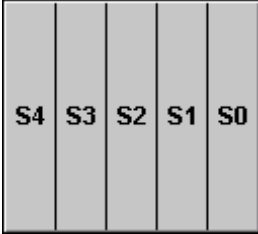
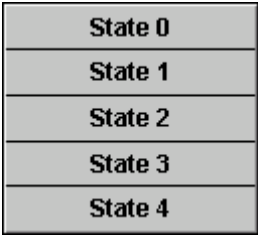
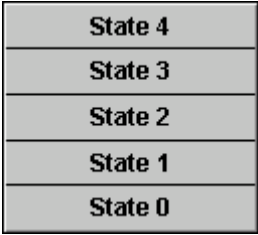
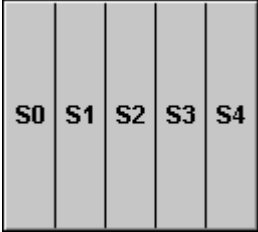
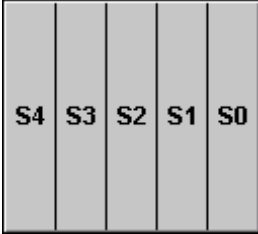
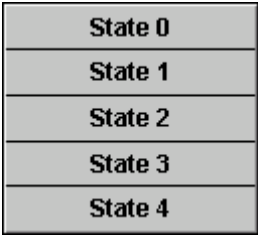
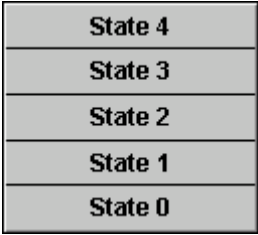

The following table describes each property in the General page.

Property	Description										
ID	The object's identifier. It is generated when the object is created. The identifier is unique within the screen where the object is on. The format of the ID's for the step buttons is STBnnnn.										
Note	You can type a note for this object.										
Shape settings	For details about the following properties, <a href="#">Section 4.3.4 Setting up the Shape of an Object</a> .  , VFTA,  , Border Color, BG Color										
External Label	Check this option if you want the object to have an external label. Set up the external label in the External Label page.										
State	Select a state as the current state so you can set the BG Color for that state. You can also see how the step button looks when the selected state is highlighted. <b>Note:</b> The current state is always highlighted by the settings defined in the Highlight Current State group, so you can not see the change of the BG color you made for the current state right away. To see the change, select another state as the current state.										
State Type	The state type of the step button. The supported types are: Value, LSB, and Custom. For details, see <a href="#">Section 4.4.1.1 State Types</a>										
State Order	Specifies how to arrange the states on the step button. There are four kinds of order: <table border="1" data-bbox="365 815 1050 1834"> <thead> <tr> <th>State Order</th> <th>Example</th> </tr> </thead> <tbody> <tr> <td>Left To Right</td> <td></td> </tr> <tr> <td>Right To Left</td> <td></td> </tr> <tr> <td>Top To Bottom</td> <td></td> </tr> <tr> <td>Bottom To Top</td> <td></td> </tr> </tbody> </table>	State Order	Example	Left To Right		Right To Left		Top To Bottom		Bottom To Top	
State Order	Example										
Left To Right											
Right To Left											
Top To Bottom											
Bottom To Top											
Data Type	The data type for the variable in the Write Address field. The supported types are: 16-bit Unsigned Integer, 16-bit BCD, 32-bit Unsigned Integer, and 32-bit BCD.										

Continued



Property		Description
Write Address	Write Address	Specifies the variable to be controlled by the step button. This variable will also be monitored to decide the state of the step button.
		Click this icon to bring up the Address Input Keypad and specify an address for this property.
		Click this icon to bring up the Select Tag dialog box and select a tag for this property.
Total States		Specifies the number of states that the step button can display and process.
Separator Color		The color of the lines that are drawn between two states.
Highlight Current State		The settings to highlight the text of the current state.
	BG Color	The color to replace the BG color of the current state.
	Text Color	The color to replace the text color of the current state.
Custom State Value...		Click this button to define the state value for each state of the step button when the State Type is Custom. For details, see <a href="#">Section 4.4.1.2 Setting the Custom States of an Object</a> .

## 5.13. Displaying Window Screen as Information Page Using Page Selectors

In a page selector, you can press a tab to view the associated page (window screen).

### 5.13.1. Basic Operations

You can configure a page selector to contain up to 8 window screens. Each of the specified window screens is a page and each page has an associated tab. You can specify the text and picture for each tab. At runtime, a page selector shows one of the specified pages in its viewing area. You can select a desired page to view by pressing the associated tab.

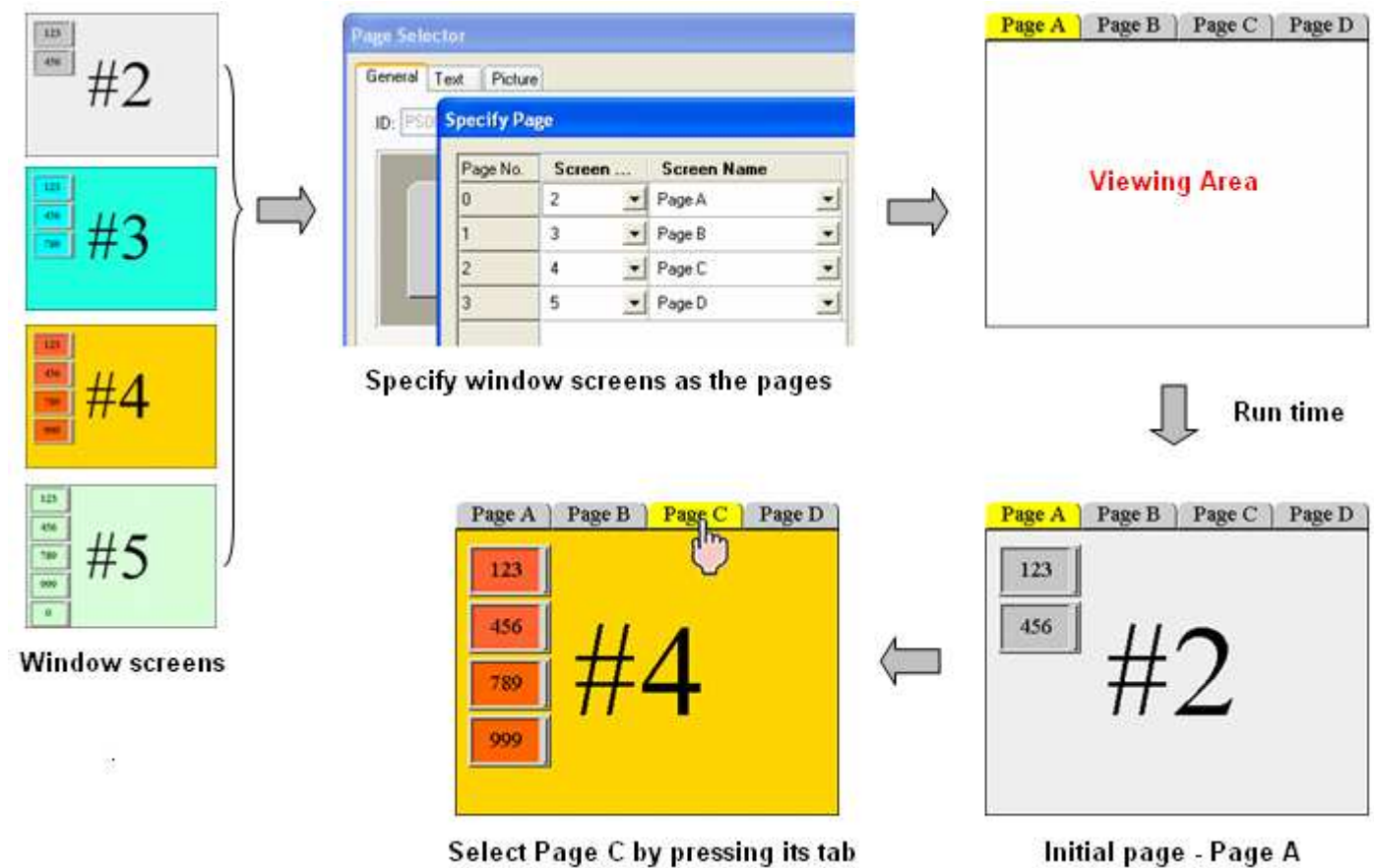

### 5.13.2. Settings

You can complete all the settings of a page selector in the Page Selector property sheet. This sheet contains the following three pages.

- **General**

Described in [Section 5.13.3.](#)

- **Text**

Described in [Section 4.3.6.](#)

- **Picture**

Described in [Section 4.3.7.](#)

### 5.13.3. General Settings

This section describes how to define the general settings for a page selector. The following is an example of the General page of the Page Selector property sheet.

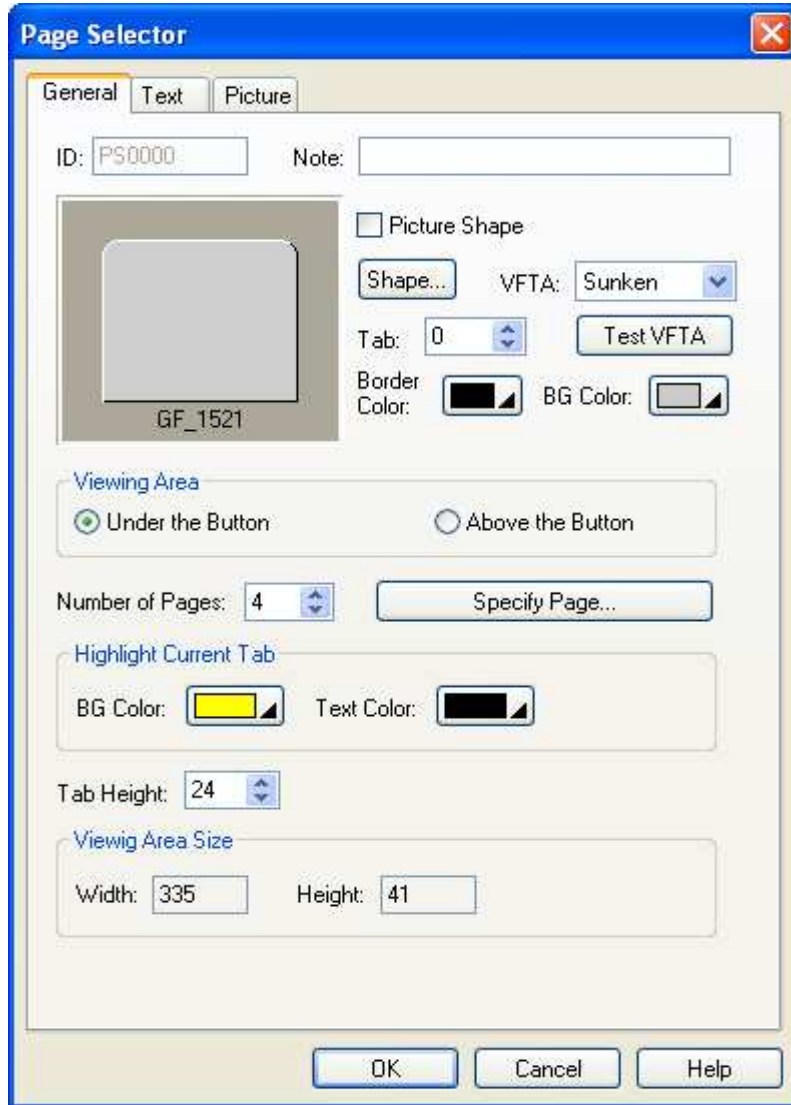

The following table describes each property in the General page.

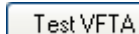
Property	Description
ID	The object's identifier. It is generated when the object is created. The identifier is unique within the screen where the object is on. The format of the ID's for the page selectors is PSnnnn.
Note	You can type a note for this object.
Shape settings	For details about the following properties, <a href="#">Section 4.3.4 Setting up the Shape of an Object</a> . Picture Shape,  , VFTA,  , Border Color, BG Color
Tab	Select a tab as the current tab so you can set the BG Color for that tab. You can also see how the tabs look when the selected tab is highlighted. <b>Note:</b> The current tab is always highlighted by the settings defined in the Highlight Current Tab group, so you can not see the change of the BG color you made for the current tab right away. To see the change, select another tab as the current tab.

Continued



Property		Description
Viewing Area		You can select Under the Tabs or Above the Tabs for the location of the viewing area. At runtime the selected page is shown here.
Number of Pages		Specifies the number of window screens this page selector contains.
Specify Page...		Click this button to open the Specify Page dialog box. You can specify the window screen for each page in this dialog box.
Highlight Current Tab		The settings to highlight the text of the current tab.
	BG Color	The color to replace the BG color of the current tab.
	Text Color	The color to replace the text color of the current tab.
Tab Height		The height of each tab.
Viewing Area Size		Specifies the size of the viewing area. <b>Note:</b> None of the specified window screens can be larger than the viewing area.
	Width	The width of the viewing area.
	Height	The height of the viewing area.





# CHAPTER 6

## LAMPS

<b>6.1 . Displaying Bit State Using Bit Lamps.....</b>	<b>1</b>
6.1.1. Basic Operations.....	1
6.1.2. Operation Options.....	1
6.1.3. Settings.....	1
6.1.4. General Settings .....	2
<b>6.2.   Displaying Word State Using Multi-state Lamps .....</b>	<b>4</b>
6.2.1. Basic Operations.....	4
6.2.2. Operation Options.....	5
6.2.3. Settings.....	5
6.2.4. General Settings .....	6
<b>6.3.   Displaying Text Information Using Message Displays.....</b>	<b>7</b>
6.3.1. Basic Operations.....	7
6.3.2. Operation Options.....	7
6.3.3. Settings.....	8
6.3.4. General Settings .....	8

## 6.1 . Displaying Bit State Using Bit Lamps

### 6.1.1. Basic Operations

You can use a bit to control the appearance of a bit lamp.

A bit lamp has two states, i.e. state 0 (Off) and state 1 (On). You can set the appearance of a bit lamp for each of the two states. At runtime, a bit lamp displays with the appearance settings corresponding to the state of the monitored bit.

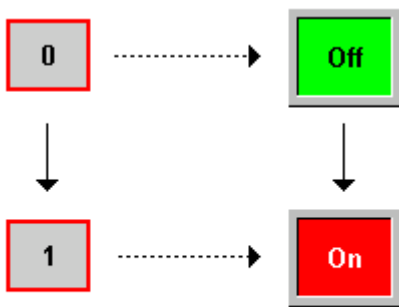

The monitored bit                      The bit lamp

### 6.1.2. Operation Options

The following operation option can be added to a bit lamp. You need to select and set this option in the Bit Lamp property sheet.

Options	Description
Visibility Control	The object can be shown or hidden either by a specified bit or by the current user level. Select and set this option in the Visibility page.

### 6.1.3. Settings

You can complete all the settings of a bit lamp in the Bit Lamp property sheet. This sheet contains the following four pages. Some of the pages appear only when they are needed.

- **General**  
Described in [Section 6.1.4.](#)
- **Label**  
Described in [Section 4.3.5.](#)
- **Visibility**  
Described in [Section 4.4.6.](#)
- **External Label**  
Described in [Section 4.3.8.](#)

### 6.1.4. General Settings

This section describes how to define the general settings for a bit lamp.

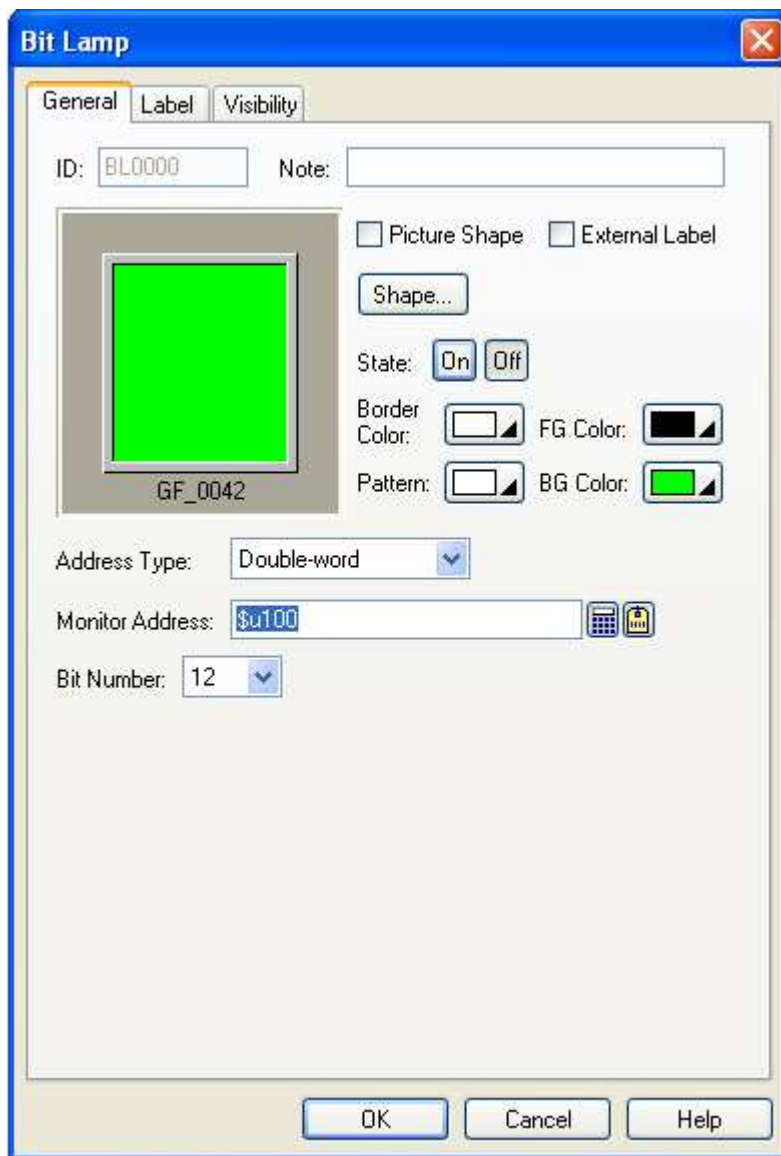





The above is an example of the General page of the Bit Lamp dialog box.

The following table describes each property in the General page.

Property	Description
ID	The object's identifier. It is generated when the object is created. The identifier is unique within the screen where the object is on. The format of the ID's for the bit lamps is BLnnnn.
Note	You can type a note for the object.
Shape settings	For details about the following properties, see <a href="#">Section 4.3.4 Setting up the Shape of an Object</a> . Picture Shape, <input type="button" value="Shape..."/> , Border Color, Pattern, FG Color, BG Color
External Label	Check this option if you want the bit lamp to have an external label. Set up the external label in the External Label page.

Continued



Property		Description								
		Click this button to change the object state to 1 (On) so you can view and set the object appearance for state 1 (On).								
		Click this button to change the object state to 0 (Off) so you can view and set the object appearance for state 0 (Off).								
Monitor Address	Address Type	Specifies the type of variable in the Monitor Address field. The bit lamps support the following three variable types:								
		<table border="1"> <thead> <tr> <th>Variable Type</th> <th>Description</th> </tr> </thead> <tbody> <tr> <td>Bit</td> <td>The variable is a bit variable.</td> </tr> <tr> <td>Word</td> <td>The variable is a word variable. You need to specify which bit of the word variable that is to be monitored. Specify the bit number (0~15) in the Bit Number field.</td> </tr> <tr> <td>Double-word</td> <td>The variable is a double-word variable. You need to specify which bit of the double-word variable that is to be monitored. Specify the bit number (0~31) in the Bit Number field.</td> </tr> </tbody> </table>	Variable Type	Description	Bit	The variable is a bit variable.	Word	The variable is a word variable. You need to specify which bit of the word variable that is to be monitored. Specify the bit number (0~15) in the Bit Number field.	Double-word	The variable is a double-word variable. You need to specify which bit of the double-word variable that is to be monitored. Specify the bit number (0~31) in the Bit Number field.
		Variable Type	Description							
		Bit	The variable is a bit variable.							
	Word	The variable is a word variable. You need to specify which bit of the word variable that is to be monitored. Specify the bit number (0~15) in the Bit Number field.								
	Double-word	The variable is a double-word variable. You need to specify which bit of the double-word variable that is to be monitored. Specify the bit number (0~31) in the Bit Number field.								
Monitor Address	Specifies the bit variable to be monitored when the Address Type is Bit. Specifies the word variable that contains the bit to be monitored when the Address Type is Word. Specifies the double-word variable that contains the bit to be monitored when the Address Type is Double-word.									
	Click this icon to bring up the Address Input Keypad and specify the desired address for the Monitor Address field.									
	Click this icon to bring up the Select Tag dialog box and select the desired tag for the Monitor Address field.									
Bit Number	Specifies which bit of the variable specified in the Monitor Address field is to be monitored.									

## 6.2. Displaying Word State Using Multi-state Lamps

### 6.2.1. Basic Operations

You can use a variable to control the appearance of a multi-state lamp.

A multi-state lamp can have up to 256 states. The maximum number of states that a multi-state lamp can have is determined by the state type and the data type of the monitored variable. The following table shows the maximum in each case.

		16-bit Variable	32-bit variable
State Type	Bit	2	2
	Value	256	256
	LSB	16	33

You need to specify the number of states for a multi-state lamp and the number must not exceed the allowed maximum. You can set the appearance of a multi-state lamp for each of its states. At runtime, a multi-state lamp displays with the appearance settings corresponding to the state of the monitored variable. The state of the monitored variable is determined by the state type and value of the variable.

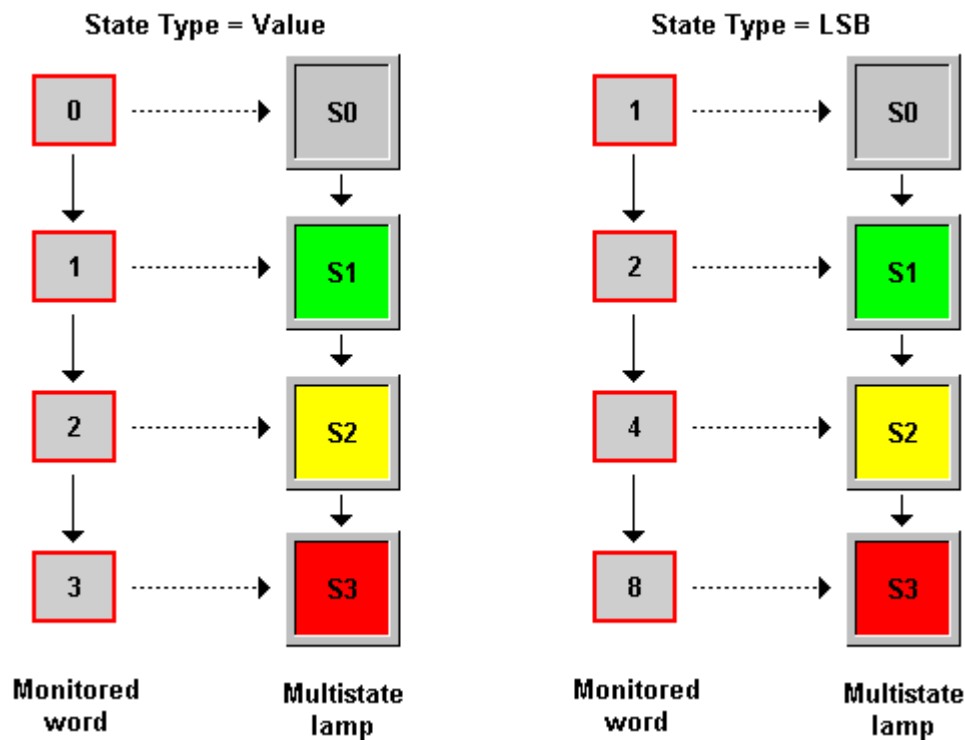

## 6.2.2. Operation Options

The following operation option can be added to a multi-state lamp. You need to select and set this option in the Multi-state Lamp property sheet.

Options	Description
Visibility Control	The object can be shown or hidden either by a specified bit or by the current user level. Select and set this option in the Visibility page.

## 6.2.3. Settings

You can complete all the settings of a multi-state lamp in the Multi-state Lamp property sheet. This dialog box contains the following five pages. Some of the pages appear only when they are needed.

- **General**

Described in [Section 6.2.4.](#)

- **Text**

Described in [Section 4.3.6.](#)

- **Picture**

Described in [Section 4.3.7.](#)

- **Visibility**

Described in [Section 4.4.6.](#)

- **External Label**



Described in [Section 4.3.8.](#)

### 6.2.4. General Settings

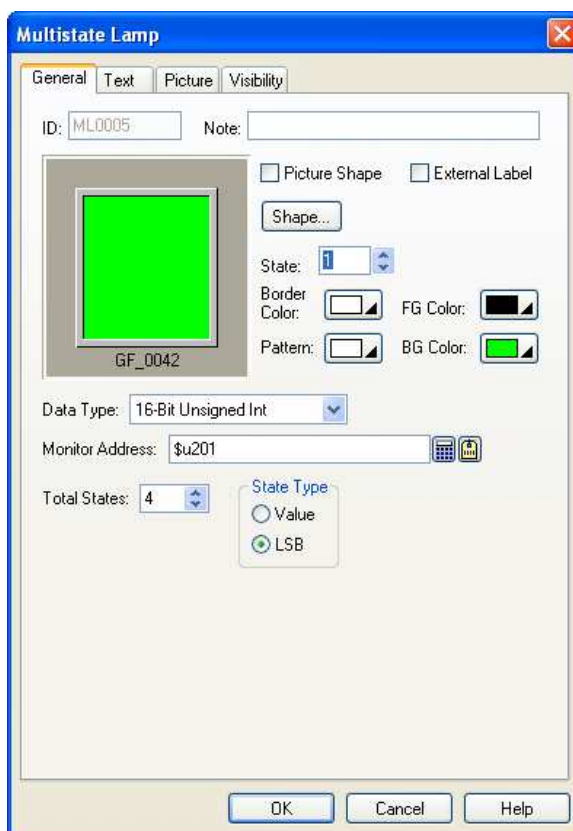
This section describes how to define the general settings for a multi-state lamp. The following is an example of the General page of the Multi-state Lamp property sheet.



The following table describes each property in the General page.

Property		Description
ID		The object's identifier. It is generated when the object is created. The identifier is unique within the screen where the object is on. The format of the ID's for the multi-state lamps is MLnnnn.
Note		You can type a note for the object.
Shape settings		For details about the following properties, see <a href="#">Section 4.3.4 Setting up the Shape of an Object</a> , Picture Shape,  , Border Color, Pattern, FG Color, BG Color
External Label		Check this option if you want the multi-state lamp to have an external label. Set up the external label in the External Label page.
State		Select a state as the current state of the multi-state lamp so you can view and set the object appearance for that state.
Data Type		The data type of the monitored variable. The supported data types include: 16-bit Unsigned Integer, 16-bit BCD, 32-bit Unsigned Integer, and 32-bit BCD.
Monitor Address	Monitor Address	Specifies the variable to be monitored.
		Click this icon to bring up the Address Input Keypad and specify an address for the Monitor Address field.
		Click this icon to bring up the Select Tag dialog box and select a tag for the Monitor Address field.
Total States		Specifies the number of states that the multi-state lamp can display.
State Type		The state type to decide the state of the monitored variable. The supported state types include Value and LSB. For details, see <a href="#">Section 4.4.1.1 State Types</a>



## 6.3. Displaying Text Information Using Message Displays

### 6.3.1. Basic Operations

You can use a variable to select and display a predefined message with a message display.

A message display can have up to 256 states. Each state can have a predefined message. The maximum number of states that a message display can have is determined by the state type and the data type of the monitored variable. The following table shows the maximum in each case.

		Type of Variable	Maximum
State Type	Bit	Bit	2
	Value	16-bit	256
		32-bit	256
	LSB	16-bit	17
32-bit		33	

You need to specify the number of states for a message display and the number must not exceed the allowed maximum. You can set the text (message) for each state. At runtime, a message display shows the message corresponding to the state of the monitored variable. The state of the monitored variable is determined by the state type and value of the variable.

**Note:** The differences between Message Display and Lamps are:

The lamps can display either text or picture or both of them, but message display can only display text. Both of the message display and lamps can display predefined text by changing the value of the monitored variable. But only the message display can perform as a marquee controlled by the value of the monitored variable and the specified running speed.

### 6.3.2. Operation Options

The following operation option can be added to a message display. You need to select and set this option in the Message Display dialog box.

Options	Description
Marquee	<p>The displayed message scrolls automatically in the specified direction. When the displayed message is not long enough to cover the whole display area, the message is duplicated to fill the uncovered area in sequence.</p> 
Visibility Control	The object can be shown or hidden either by a specified bit or by the current user level. Select and set this option in the Visibility page.



### 6.3.3. Settings

You can complete all the settings of a message display in the Message Display dialog box. This dialog box contains the following four pages. Some of the pages appear only when they are needed.

- **General**

Described in [Section 7.9.4.](#)

- **Text**

Described in [Section 4.3.6.](#)

- **Visibility**

Described in [Section 4.4.6.](#)

- **External Label**

Described in [Section 4.3.8.](#)

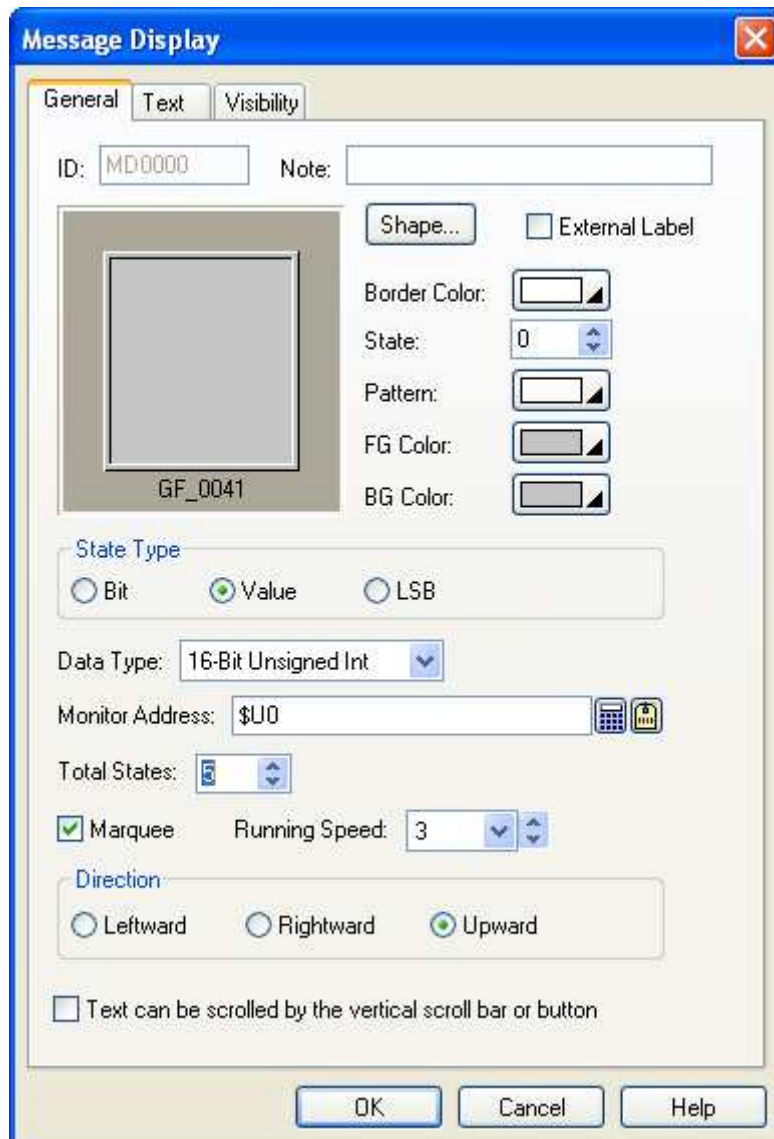

### 6.3.4. General Settings

This section describes how to define the general settings for a message display. The following is an example of the General page of the Message Display property sheet.



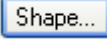

The following table describes each property in the General page.

Property		Description
ID		The object's identifier. It is generated when the object is created. The identifier is unique within the screen where the object is on. The format of the ID's for the message displays is MDnnnn.
Note		You can type a note for the object.
Shape settings		For details about the following properties, <a href="#">Section 4.3.4 Setting up the Shape of an Object</a> .  , Border Color, Pattern, FG Color, BG Color
External Label		Check this option if you want the message display to have an external label. Set up the external label in the External Label page.
State		Select a state as the current state of the message display so you can view and set the Pattern, FG Color, BG Color for that state.
State Type		The state type of the variable that controls the message display. The supported state types include Bit, Value and LSB. For details, see <a href="#">Section 4.4.1.1 State Types</a>
Data Type		The data type of the variable that controls the message display. The supported data types include: Bit, 16-bit Unsigned Integer, 16-bit BCD, 32-bit Unsigned Integer, and 32-bit BCD.
Monitor Address		Specifies the variable that controls the message display. Click  to enter an address for this field. Click  to select a tag for this field.
Total States		Specifies the number of states of the message display.
Marquee	Marquee	Select this item if you want the displayed message scrolls automatically.
	Running Speed	The speed of scrolling. Select from 1 to 10; The speed of 1 is the slowest and the speed of 10 is the fastest.
	Direction	The direction of scrolling. The supported directions include Leftward, Rightward, and Upward.
Text can be scrolled by the vertical scroll bar or button		Select this option so you can scroll the content of the message display vertically using the associated scroll buttons or scroll bar.



## CHAPTER 7

# DISPLAYING AND INPUTTING DATA

<b>7.1. Numeric Entries .....</b>	<b>1</b>
7.1.1. Operation Options.....	1
7.1.2. Settings.....	2
7.1.3. General Settings.....	2
7.1.4. Advanced Settings for Numeric Entries .....	5
<b>7.2. Numeric Displays .....</b>	<b>8</b>
7.2.1. Operation Options.....	8
7.2.2. Settings.....	8
7.2.3. General Settings.....	9
7.2.4. Advanced Settings.....	11
<b>7.3. Advanced Numeric Displays .....</b>	<b>12</b>
7.3.1. Advanced Features.....	12
7.3.2. Operation Options.....	12
7.3.3. Settings.....	13
7.3.4. General Settings.....	13
7.3.5. Range Settings .....	16
<b>7.4. Character Entries .....</b>	<b>18</b>
7.4.1. Operation Options.....	18
7.4.2. Settings.....	18
7.4.3. General Settings.....	19
7.4.4. Advanced Settings.....	21
<b>7.5. Character Displays.....</b>	<b>23</b>
7.5.1. Operation Options.....	23
7.5.2. Settings.....	23
7.5.3. General Settings.....	24
<b>7.6. Time Displays .....</b>	<b>25</b>
7.6.1. Settings.....	25
<b>7.7. Date Displays .....</b>	<b>26</b>
7.7.1. Settings.....	26

<b>7.8. Day-of-week Displays .....</b>	<b>27</b>
7.8.1. Settings.....	27
7.8.2. General Settings.....	27



## 7.1. Numeric Entries

You can enter a value and change the specified variable using a numeric entry.

### 7.1.1. Operation Options

The following operation options can be added to a numeric entry. Select and set up the options in the Numeric Entry property sheet.

Options	Description
Scaling	<p>The value of the monitored variable will be displayed in a scaled manner. The following is the scaling formula.</p> $\text{DisplayedValue} = \text{MonitoredValue} * \text{Gain} + \text{Offset}$ <p>If the option is selected, the entered value will be scaled by the following formula with the same coefficients (<i>Gain</i> and <i>Offset</i>) before it is output.</p> $\text{OutputValue} = (\text{EnteredValue} - \text{Offset}) / \text{Gain}$ <p>Select and set this option in the Advanced page.</p> <p><b>Note:</b> The <i>Gain</i> and <i>Offset</i> are 32-bit floating point numbers. They have at most 6 significant digits. The rounding and truncation errors may happen.</p>
Range Check	<p>The numeric entry will verify the entered value according to the specified maximum and minimum. If the entered value is not within the allowable range, the value will not be output. Select and set this option in the Advanced page.</p> <p><b>Note 1:</b> When the scaling option is selected, the output value instead of the entered value is verified.</p> $\text{OutputValue} = (\text{EnteredValue} - \text{Offset}) / \text{Gain}$ <p><b>Note 2:</b> When the scaling option is selected, the allowable maximum and minimum shown on the numeric keypad are the scaled version of the specified maximum and minimum.</p> $\text{ScaledMaximum} = \text{Maximum} * \text{Gain} + \text{Offset}$ $\text{ScaledMinimum} = \text{Minimum} * \text{Gain} + \text{Offset}$
Touch Operation Control	You can enable or disable the touch operation of the object by the specified bit or by the current user level. Select and set up this option in the Advanced page.
Timeout	If the keypad for the data entry receives no input for the specified time period, the data entry operation will be cancelled.
Notification	The Object will notify the specified bit of a successful data entry operation. Select and set up this option in the Advanced page.
Operator Confirmation	When a value is entered by the operator, the Confirmation box will display for the operator confirmation. If the operator selects "Yes", the object will write the entered data to the specified variable. If the operator selects "No" or the operator does not respond within the specified time period (Maximum Waiting Time), the data entry operation will be cancelled. Select and set up this option in the Advanced page.
Operation Logging	The entered value and the time of the data entry will be recorded. Select and set up this option in the Advanced page.
Visibility Control	You can show or hide the object by the specified bit or by the current user level. Select and set up this option in the Visibility page.

## 7.1.2. Settings

You can complete all the settings of a numeric entry in the Numeric Entry property sheet. This sheet contains the following four pages. Some of the pages appear only when they are needed.

- **General**

Described in [Section 7.1.3.](#)

- **Advanced**

Described in [Section 7.1.4.](#)

- **Visibility**

Described in [Section 4.4.6.](#)

- **External Label**

Described in [Section 4.3.8.](#)



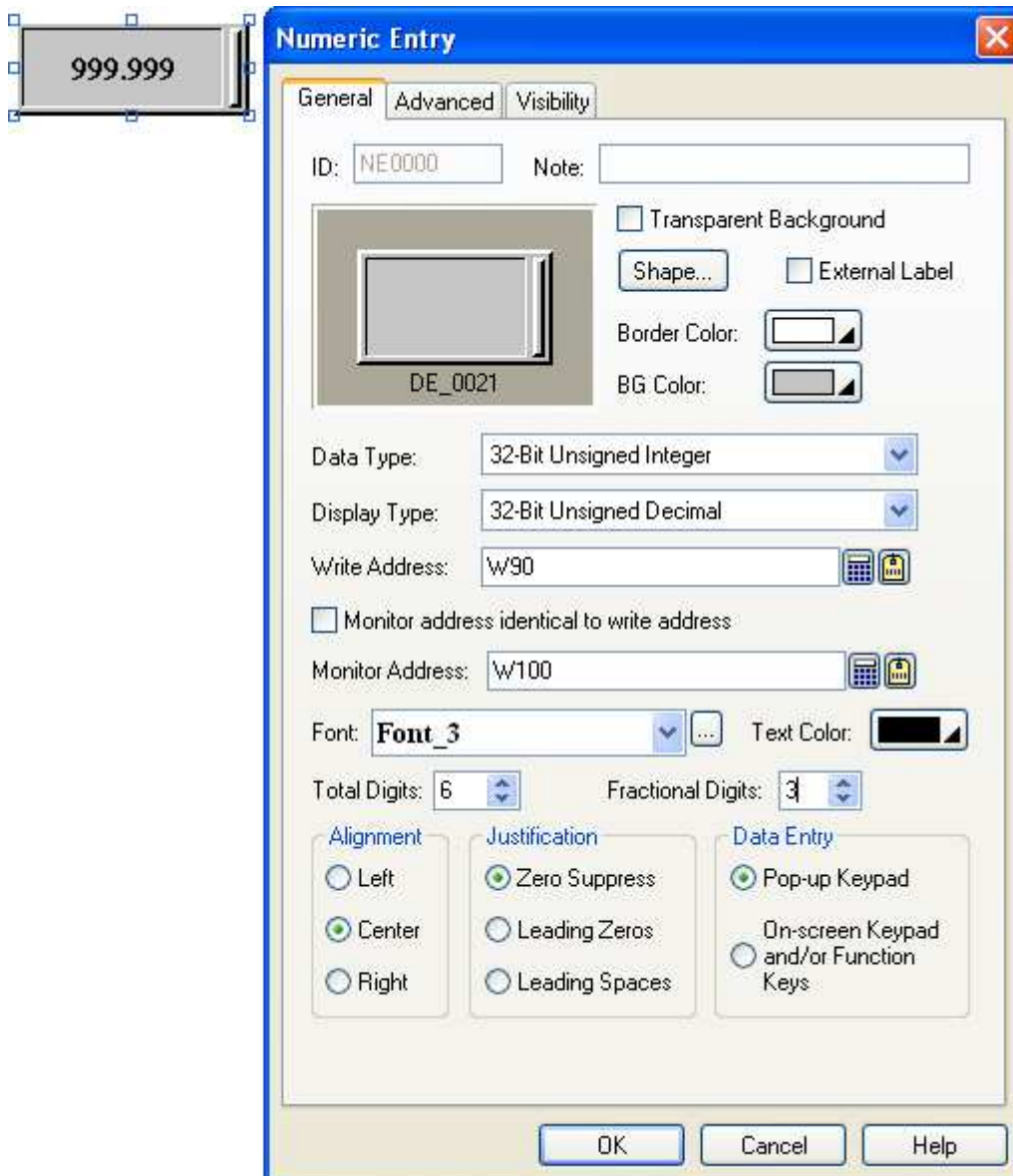

## 7.1.3. General Settings

This section describes how to define the general settings for a numeric entry. The following is an example of the General page of the Numeric Entry property sheet.





The following table describes each property in the General page.

Property	Description																								
ID	The object's identifier. It is generated when the object is created. The identifier is unique within the screen where the object is on. The format of the ID's for the numeric entries is NEnnnn.																								
Note	You can type a note for the object.																								
Transparent Background	Select this option if you want the object to have a transparent background.																								
Shape settings	For details about the following properties, see <a href="#">Section 4.3.4 Setting up the Shape of an Object</a> .  , Border Color, BG Color.																								
External Label	Check this option if you want the object to have an external label. Set up the external label in the External Label page.																								
Data Type	The data type of the destination variable and the monitored variable. The supported data types include: 16-Bit Unsigned Integer, 32-Bit Unsigned Integer, 16-Bit Signed Integer, 32-Bit Signed Integer, 16-Bit BCD, 32-Bit BCD, 32-Bit Floating Point, 16-Bit Signed BCD (LMB), 32-Bit Signed BCD (LMB), 16-Bit Signed BCD (LMD), and 32-Bit Signed BCD (LMD).																								
Display Type	The display type for the value of the monitored variable. The following table shows the available display types for each data type. <table border="1" data-bbox="300 824 1501 1368"> <thead> <tr> <th>Data Type</th> <th>Available Display Types</th> </tr> </thead> <tbody> <tr> <td>16-Bit Unsigned Integer</td> <td>16-Bit Unsigned Decimal, 16-Bit Hexadecimal, 16-Bit Octal</td> </tr> <tr> <td>32-Bit Unsigned Integer</td> <td>32-Bit Unsigned Decimal, 32-Bit Hexadecimal, 32-Bit Octal, Password</td> </tr> <tr> <td>16-Bit Signed Integer</td> <td>16-Bit Signed Decimal</td> </tr> <tr> <td>32-Bit Signed Integer</td> <td>32-Bit Signed Decimal</td> </tr> <tr> <td>16-Bit BCD</td> <td>16-Bit Unsigned Decimal</td> </tr> <tr> <td>32-Bit BCD</td> <td>32-Bit Unsigned Decimal</td> </tr> <tr> <td>32-Bit Floating Point</td> <td>32-Bit Floating Point</td> </tr> <tr> <td>16-Bit Signed BCD (LMB)</td> <td>16-Bit Signed Decimal</td> </tr> <tr> <td>32-Bit Signed BCD (LMB)</td> <td>32-Bit Signed Decimal</td> </tr> <tr> <td>16-Bit Signed BCD (LMD)</td> <td>16-Bit Signed Decimal</td> </tr> <tr> <td>32-Bit Signed BCD (LMD)</td> <td>32-Bit Signed Decimal</td> </tr> </tbody> </table>	Data Type	Available Display Types	16-Bit Unsigned Integer	16-Bit Unsigned Decimal, 16-Bit Hexadecimal, 16-Bit Octal	32-Bit Unsigned Integer	32-Bit Unsigned Decimal, 32-Bit Hexadecimal, 32-Bit Octal, Password	16-Bit Signed Integer	16-Bit Signed Decimal	32-Bit Signed Integer	32-Bit Signed Decimal	16-Bit BCD	16-Bit Unsigned Decimal	32-Bit BCD	32-Bit Unsigned Decimal	32-Bit Floating Point	32-Bit Floating Point	16-Bit Signed BCD (LMB)	16-Bit Signed Decimal	32-Bit Signed BCD (LMB)	32-Bit Signed Decimal	16-Bit Signed BCD (LMD)	16-Bit Signed Decimal	32-Bit Signed BCD (LMD)	32-Bit Signed Decimal
Data Type	Available Display Types																								
16-Bit Unsigned Integer	16-Bit Unsigned Decimal, 16-Bit Hexadecimal, 16-Bit Octal																								
32-Bit Unsigned Integer	32-Bit Unsigned Decimal, 32-Bit Hexadecimal, 32-Bit Octal, Password																								
16-Bit Signed Integer	16-Bit Signed Decimal																								
32-Bit Signed Integer	32-Bit Signed Decimal																								
16-Bit BCD	16-Bit Unsigned Decimal																								
32-Bit BCD	32-Bit Unsigned Decimal																								
32-Bit Floating Point	32-Bit Floating Point																								
16-Bit Signed BCD (LMB)	16-Bit Signed Decimal																								
32-Bit Signed BCD (LMB)	32-Bit Signed Decimal																								
16-Bit Signed BCD (LMD)	16-Bit Signed Decimal																								
32-Bit Signed BCD (LMD)	32-Bit Signed Decimal																								
Write Address	Specifies the destination variable where the entered value will be written to. Click  to enter an address for this field. Click  to select a tag for this field.																								
Monitor Address identical to Write Address	Specifies that the monitored variable is the same as the destination variable. With this item checked, you don't need to specify the monitored variable in the Monitor Address field.																								
Monitor Address	Specifies the monitored variable. Click  to enter an address for this field. Click  to select a tag for this field.																								
Font	The font of the displayed value.																								
Text Color	The color of the displayed value.																								
Total Digits	The number of digits to be displayed. <b>Note:</b> This property applies to the display of the initial value, the allowable minimum, and the allowable maximum on the numeric keypad.																								

Continued





Property	Description																																																												
Fractional Digits	<p>When the Display Type is 32-bit Floating Point, this property specifies the number of fractional digits to be displayed.</p> <p>When the Display Type is not 32-bit Floating Point, this property specifies not only the number of fractional digits to be displayed but also the number of least significant digits to be displayed as the fractional part. With this feature, an integer can be shown and entered as a fixed point number. When the Fractional Digits is nonzero, say N, the entered value will be converted to an integer according to the following formula before being output.</p> <p>OutputValue = EnteredValue * (Nth power of 10)</p> <p><b>Example 1:</b></p> <table border="1" data-bbox="300 533 1455 775"> <thead> <tr> <th>Display Type</th> <th>Total Digits</th> <th>Fractional Digits</th> <th>Justification</th> <th>Monitored Value</th> <th>Displayed Value</th> </tr> </thead> <tbody> <tr> <td>32-bit Floating Point</td> <td>4</td> <td>2</td> <td>Zero Suppress</td> <td>12.34</td> <td>12.34</td> </tr> <tr> <td>32-bit Floating Point</td> <td>4</td> <td>2</td> <td>Zero Suppress</td> <td>123.4</td> <td>23.40</td> </tr> <tr> <td>16-bit Signed Decimal</td> <td>5</td> <td>2</td> <td>Zero Suppress</td> <td>12345</td> <td>123.45</td> </tr> <tr> <td>16-bit Signed Decimal</td> <td>5</td> <td>2</td> <td>Zero Suppress</td> <td>-5</td> <td>-0.05</td> </tr> </tbody> </table> <p><b>Example 2:</b></p> <table border="1" data-bbox="300 853 1203 1140"> <thead> <tr> <th>Display Type</th> <th>Total Digits</th> <th>Fractional Digits</th> <th>Entered Value</th> <th>Output Value</th> </tr> </thead> <tbody> <tr> <td>32-bit Floating Point</td> <td>4</td> <td>2</td> <td>12.34</td> <td>12.34</td> </tr> <tr> <td>32-bit Floating Point</td> <td>4</td> <td>2</td> <td>123.4</td> <td>Error!</td> </tr> <tr> <td>16-bit Signed Decimal</td> <td>5</td> <td>2</td> <td>123.45</td> <td>12345</td> </tr> <tr> <td>16-bit Signed Decimal</td> <td>5</td> <td>2</td> <td>-0.05</td> <td>-5</td> </tr> <tr> <td>16-bit Signed Decimal</td> <td>5</td> <td>2</td> <td>3</td> <td>300</td> </tr> </tbody> </table> <p><b>Note:</b> This property applies to the display of the initial value, the allowable minimum, and the allowable maximum on the numeric keypad.</p>	Display Type	Total Digits	Fractional Digits	Justification	Monitored Value	Displayed Value	32-bit Floating Point	4	2	Zero Suppress	12.34	12.34	32-bit Floating Point	4	2	Zero Suppress	123.4	23.40	16-bit Signed Decimal	5	2	Zero Suppress	12345	123.45	16-bit Signed Decimal	5	2	Zero Suppress	-5	-0.05	Display Type	Total Digits	Fractional Digits	Entered Value	Output Value	32-bit Floating Point	4	2	12.34	12.34	32-bit Floating Point	4	2	123.4	Error!	16-bit Signed Decimal	5	2	123.45	12345	16-bit Signed Decimal	5	2	-0.05	-5	16-bit Signed Decimal	5	2	3	300
Display Type	Total Digits	Fractional Digits	Justification	Monitored Value	Displayed Value																																																								
32-bit Floating Point	4	2	Zero Suppress	12.34	12.34																																																								
32-bit Floating Point	4	2	Zero Suppress	123.4	23.40																																																								
16-bit Signed Decimal	5	2	Zero Suppress	12345	123.45																																																								
16-bit Signed Decimal	5	2	Zero Suppress	-5	-0.05																																																								
Display Type	Total Digits	Fractional Digits	Entered Value	Output Value																																																									
32-bit Floating Point	4	2	12.34	12.34																																																									
32-bit Floating Point	4	2	123.4	Error!																																																									
16-bit Signed Decimal	5	2	123.45	12345																																																									
16-bit Signed Decimal	5	2	-0.05	-5																																																									
16-bit Signed Decimal	5	2	3	300																																																									
Alignment	The alignment of the displayed value. There are three types of alignment: Left, Center, and Right.																																																												
Justification	The justification of the displayed value. There are three types of justification: <table border="1" data-bbox="300 1296 1455 1469"> <thead> <tr> <th>Option</th> <th>Description</th> </tr> </thead> <tbody> <tr> <td>Zero Suppress</td> <td>The leading digits will not display when they are 0.</td> </tr> <tr> <td>Leading Zeros</td> <td>All digits will display.</td> </tr> <tr> <td>Leading Spaces</td> <td>The leading digits will display as blank character when they are 0.</td> </tr> </tbody> </table>	Option	Description	Zero Suppress	The leading digits will not display when they are 0.	Leading Zeros	All digits will display.	Leading Spaces	The leading digits will display as blank character when they are 0.																																																				
Option	Description																																																												
Zero Suppress	The leading digits will not display when they are 0.																																																												
Leading Zeros	All digits will display.																																																												
Leading Spaces	The leading digits will display as blank character when they are 0.																																																												
Data Entry	Specifies how to enter a value for the numeric entry at runtime. There are two options: <table border="1" data-bbox="300 1527 1455 1872"> <thead> <tr> <th>Option</th> <th>Description</th> </tr> </thead> <tbody> <tr> <td>Pop-up Keypad</td> <td>You can bring up the keypad by pressing the numeric entry and enter a value with the keypad.</td> </tr> <tr> <td>On-screen Keypad and/or Function Keys</td> <td>You can move the cursor by using the function buttons with the operation of Select Next Data Entry Object or Select Previous Data Entry Object to select the numeric entry. If there is an on-screen keypad you can enter a value for the numeric entry right away. You can also use the function buttons with the operation of Increase Value By One or Decrease Value By One to change the value of the destination variable.</td> </tr> </tbody> </table> <p><b>Note:</b> When On-screen Keypad and/or Function Keys option is selected, you can only enter a value for the numeric entry with the input focus. To set the input focus on the corresponding object, you need to click the object first.</p>	Option	Description	Pop-up Keypad	You can bring up the keypad by pressing the numeric entry and enter a value with the keypad.	On-screen Keypad and/or Function Keys	You can move the cursor by using the function buttons with the operation of Select Next Data Entry Object or Select Previous Data Entry Object to select the numeric entry. If there is an on-screen keypad you can enter a value for the numeric entry right away. You can also use the function buttons with the operation of Increase Value By One or Decrease Value By One to change the value of the destination variable.																																																						
Option	Description																																																												
Pop-up Keypad	You can bring up the keypad by pressing the numeric entry and enter a value with the keypad.																																																												
On-screen Keypad and/or Function Keys	You can move the cursor by using the function buttons with the operation of Select Next Data Entry Object or Select Previous Data Entry Object to select the numeric entry. If there is an on-screen keypad you can enter a value for the numeric entry right away. You can also use the function buttons with the operation of Increase Value By One or Decrease Value By One to change the value of the destination variable.																																																												



### 7.1.4. Advanced Settings for Numeric Entries

This section describes how to define the advanced settings for the numeric entries. The following is an example of the Advanced page of the Numeric Entry property sheet.

The following table describes each property in the Advanced page.

Property		Description
Scaling	Scaling	Check this option if you want the value of the monitored variable to be displayed in a scaled manner. The following is the scaling formula. $\text{DisplayedValue} = \text{MonitoredValue} * \text{Gain} + \text{Offset}$ If this option is selected, the entered value will be scaled by the following formula with the same coefficients ( <i>Gain</i> and <i>Offset</i> ) before it is output. $\text{OutputValue} = (\text{EnteredValue} - \text{Offset}) / \text{Gain}$ <b>Note:</b> The <i>Gain</i> and <i>Offset</i> are 32-bit floating point numbers. They have at most 6 significant digits. The rounding and truncation errors may happen.
	Gain	The <i>Gain</i> of the scaling formulas.
	Offset	The <i>Offset</i> of the scaling formulas.



Property		Description						
Range Check	Range Check	<p>Check this option if you want the numeric entry to verify the entered value according to the specified minimum and maximum. If the entered value is not within the allowable range, the entered value will not be output.</p> <p><b>Note 1:</b> When the scaling option is selected, the output value instead of the entered value is verified.</p> $\text{OutputValue} = (\text{EnteredValue} - \text{Offset}) / \text{Gain}$ <p><b>Note 2:</b> When the scaling option is selected, the allowable maximum and minimum shown on the keypad are the scaled version of the specified maximum and minimum.</p> $\text{ScaledMaximum} = \text{Maximum} * \text{Gain} + \text{Offset}$ $\text{ScaledMinimum} = \text{Minimum} * \text{Gain} + \text{Offset}$						
	Variable Range	Check this option if the minimum and maximum are specified by the designated variables at runtime.						
	Min.	<p>Specifies the minimum when the Variable Range is not selected.</p> <p>When the Variable Range is selected, this property specifies the variable that stores the minimum at runtime. Click  to enter an address. Click  to select a tag.</p>						
	Max.	<p>Specifies the maximum when the Variable Range is not selected.</p> <p>When the Variable Range is selected, this property specifies the variable that stores the maximum at runtime. Click  to enter an address. Click  to select a tag.</p>						
Touch Operation Control	Enabled by Bit	Check this option so the touch operation of the numeric entry will be enabled and disabled by the specified bit.						
	Control Bit	<p>Specifies the bit that enables and disables the touch operation.</p> <p>Click  to enter a bit address. Click  to select a bit tag.</p>						
	Enabling State	Specifies the state (On or Off) that enables the touch operation.						
	Enabled by User Level	Check this item so the touch operation of the numeric entry will be enabled and disabled by the current user level.						
	Lowest Enabling User Level	Specifies the lowest user level that is required to enable the touch operation.						
	Show Disabled Sign	Check this option so the touch operation disabled sign will be shown on the numeric entry when the touch operation is disabled.						
Timeout	Timeout	Check this option so the data entry will be cancelled if the numeric keypad does not receive any input within the specified time.						
	Timeout Time	Specifies the maximum time that the numeric keypad will wait to get a new input. If there is no input within the specified time, the numeric keypad will be closed and the data entry will be cancelled.						
Notification	Notification	Check this option so the numeric entry will notify the specified bit after it finishes outputting the entered value to the destination variable.						
	Signal	<p>Select one of the following signal for the notification:</p> <table border="1"> <thead> <tr> <th>Signal</th> <th>Description</th> </tr> </thead> <tbody> <tr> <td>Level</td> <td>Set the specified bit to the specified state.</td> </tr> <tr> <td>Pulse</td> <td>Send a positive pulse to the specified bit.</td> </tr> </tbody> </table>	Signal	Description	Level	Set the specified bit to the specified state.	Pulse	Send a positive pulse to the specified bit.
	Signal	Description						
	Level	Set the specified bit to the specified state.						
	Pulse	Send a positive pulse to the specified bit.						
Bit	Specifies the bit that receives the notification.							
State	Specifies the state (On or Off) that is used for the notification.							

Continued



Property		Description
Operator Confirmation	Operator Confirmation	Check this option if you want the operator to confirm what he/she enters for the numeric entry. The Confirmation box will be displayed when a value is entered for the numeric entry. If the operator selects "Yes" in the Confirmation box, the numeric entry will write the entered value to the specified variable. If the operator selects "No" or the operator does not respond within the specified time period (Maximum Waiting Time), the numeric entry will cancel the data entry operation.
	Maximum Waiting Time	Specifies the maximum time that the numeric entry will wait for the operator's confirmation. The data entry will be cancelled if the operator does not respond within this time.
Operation Logging	Operation Logging	Check this option so the following three items will be recorded in the operation log when the numeric entry outputs the entered value. There are three recorded items: 1) The time when the operation is performed 2) The entered value 3) The predefined operation message
	Message	Enter the operation message of the first language here.
		Click this button to bring up the Operation Message dialog box that you can edit the operation message for all the languages.



## 7.2. Numeric Displays

You can use a numeric display to show the value of the specified variable.

### 7.2.1. Operation Options

The following operation options can be added to a numeric display. Select and set up the options in the Numeric Display property sheet.

Options	Description
Scaling	The value of the monitored variable will be scaled by the following formula before it is displayed. $DisplayedValue = MonitoredValue * Gain + Offset$ Select and set this option in the Advanced page. <b>Note:</b> The <i>Gain</i> and <i>Offset</i> are 32-bit floating point numbers. They have at most 6 significant digits. The rounding and truncation errors may happen.
Range Display	You can specify a low limit and a high limit for the numeric display. The limits can be constants or variables. At runtime, when the value of the monitored variable is below the low limit, the numeric display shows the value with the text color and the BG color set for the low limit. When the value of the monitored variable is over the high limit, the numeric display shows the value with the text color and the BG color set for the high limit.
Visibility Control	You can show and hide the numeric display by the specified bit or the current user level. Select and set this option in the Visibility page.

### 7.2.2. Settings

You can complete all the settings of a numeric display in the Numeric Display property sheet. This sheet contains the following four pages. Some of the pages appear only when they are needed.

- **General**  
Described in [Section 7.2.3.](#)
- **Advanced**  
Described in [Section 7.2.4.](#)
- **Visibility**  
Described in [Section 4.4.6.](#)
- **External Label**  
Described in [Section 4.3.8.](#)



### 7.2.3. General Settings

This section describes how to define the general settings for a numeric display. The following is an example of the General page of the Numeric Display property sheet.

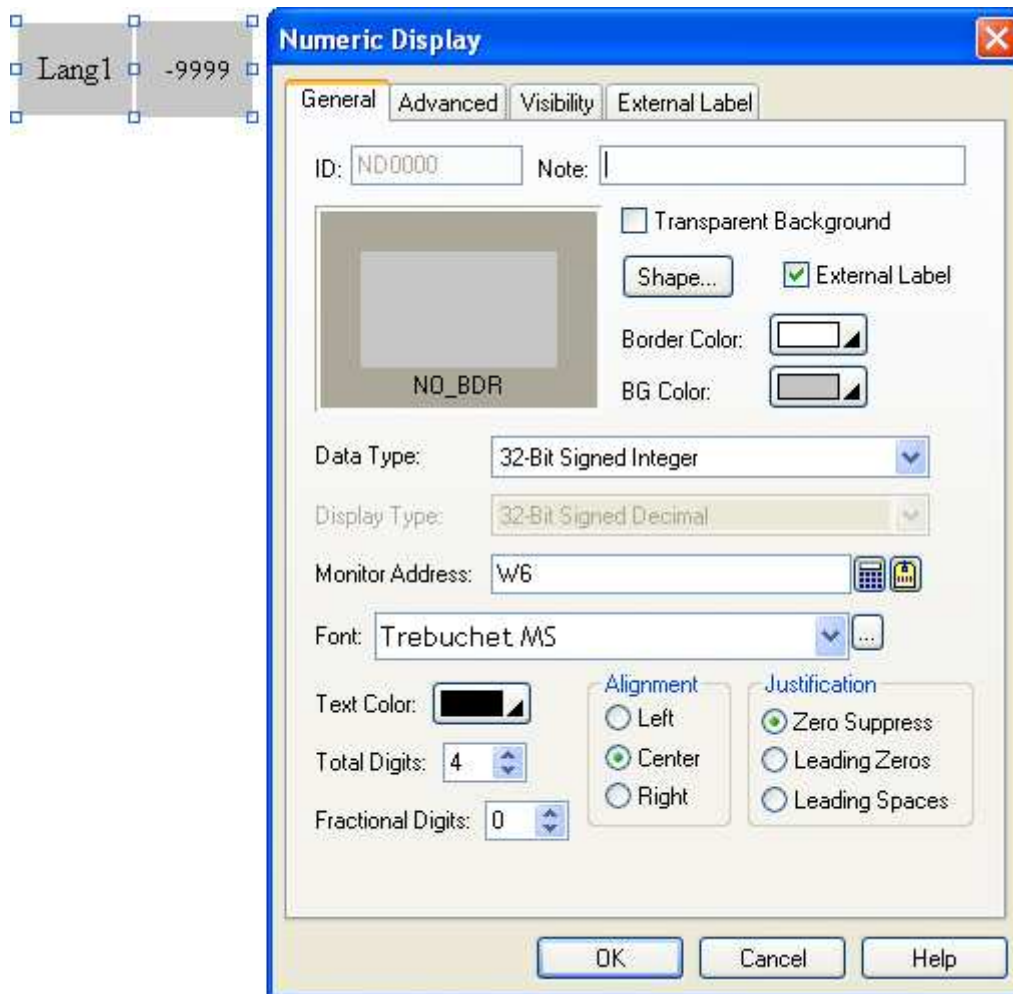



The following table describes each property in the General page.

Property	Description
ID	The object's identifier. It is generated when the object is created. The identifier is unique within the screen where the object is on. The format of the ID's for the numeric displays is NDnnnn.
Note	You can type a note for the object.
Transparent Background	Select this option if you want the object to have a transparent background.
Shape settings	For details about the following properties, see <a href="#">Section 4.3.4 Setting up the Shape of an Object.</a> <a href="#">Shape...</a> , Border Color, BG Color
External Label	Check this option if you want the object to have an external label. Set up the external label in the External Label page.
Data Type	The data type of the monitored variable. The supported data types include: 16-Bit Unsigned Integer, 32-Bit Unsigned Integer, 16-Bit Signed Integer, 32-Bit Signed Integer, 16-Bit BCD, 32-Bit BCD, 32-Bit Floating Point, 16-Bit Signed BCD (LMB), 32-Bit Signed BCD (LMB), 16-Bit Signed BCD (LMD), and 32-Bit Signed BCD (LMD).

Continued



Property	Description																														
Display Type	<p>The display type for the value of the monitored variable. The following table shows the available display types for each data type.</p> <table border="1"> <thead> <tr> <th>Data Type</th> <th>Available Display Types</th> </tr> </thead> <tbody> <tr> <td>16-Bit Unsigned Integer</td> <td>16-Bit Unsigned Decimal, 16-Bit Hexadecimal, 16-Bit Octal</td> </tr> <tr> <td>32-Bit Unsigned Integer</td> <td>32-Bit Unsigned Decimal, 32-Bit Hexadecimal, 32-Bit Octal</td> </tr> <tr> <td>16-Bit Signed Integer</td> <td>16-Bit Signed Decimal</td> </tr> <tr> <td>32-Bit Signed Integer</td> <td>32-Bit Signed Decimal</td> </tr> <tr> <td>16-Bit BCD</td> <td>16-Bit Unsigned Decimal</td> </tr> <tr> <td>32-Bit BCD</td> <td>32-Bit Unsigned Decimal</td> </tr> <tr> <td>32-Bit Floating Point</td> <td>32-Bit Floating Point</td> </tr> <tr> <td>16-Bit Signed BCD (LMB)</td> <td>16-Bit Signed Decimal</td> </tr> <tr> <td>32-Bit Signed BCD (LMB)</td> <td>32-Bit Signed Decimal</td> </tr> <tr> <td>16-Bit Signed BCD (LMD)</td> <td>16-Bit Signed Decimal</td> </tr> <tr> <td>32-Bit Signed BCD (LMD)</td> <td>32-Bit Signed Decimal</td> </tr> </tbody> </table>	Data Type	Available Display Types	16-Bit Unsigned Integer	16-Bit Unsigned Decimal, 16-Bit Hexadecimal, 16-Bit Octal	32-Bit Unsigned Integer	32-Bit Unsigned Decimal, 32-Bit Hexadecimal, 32-Bit Octal	16-Bit Signed Integer	16-Bit Signed Decimal	32-Bit Signed Integer	32-Bit Signed Decimal	16-Bit BCD	16-Bit Unsigned Decimal	32-Bit BCD	32-Bit Unsigned Decimal	32-Bit Floating Point	32-Bit Floating Point	16-Bit Signed BCD (LMB)	16-Bit Signed Decimal	32-Bit Signed BCD (LMB)	32-Bit Signed Decimal	16-Bit Signed BCD (LMD)	16-Bit Signed Decimal	32-Bit Signed BCD (LMD)	32-Bit Signed Decimal						
Data Type	Available Display Types																														
16-Bit Unsigned Integer	16-Bit Unsigned Decimal, 16-Bit Hexadecimal, 16-Bit Octal																														
32-Bit Unsigned Integer	32-Bit Unsigned Decimal, 32-Bit Hexadecimal, 32-Bit Octal																														
16-Bit Signed Integer	16-Bit Signed Decimal																														
32-Bit Signed Integer	32-Bit Signed Decimal																														
16-Bit BCD	16-Bit Unsigned Decimal																														
32-Bit BCD	32-Bit Unsigned Decimal																														
32-Bit Floating Point	32-Bit Floating Point																														
16-Bit Signed BCD (LMB)	16-Bit Signed Decimal																														
32-Bit Signed BCD (LMB)	32-Bit Signed Decimal																														
16-Bit Signed BCD (LMD)	16-Bit Signed Decimal																														
32-Bit Signed BCD (LMD)	32-Bit Signed Decimal																														
Monitor Address	<p>Specifies the monitored variable.</p> <p>Click  to enter an address for this field. Click  to select a tag for this field.</p>																														
Font	The font of the displayed value.																														
Text Color	The color of the displayed value.																														
Total Digits	The number of digits to be displayed.																														
Fractional Digits	<p>When the Display Type is 32-bit Floating Point, this property specifies the number of fractional digits to be displayed.</p> <p>When the Display Type is not 32-bit Floating Point, this property specifies not only the number of fractional digits to be displayed but also the number of least significant digits to be displayed as the fractional part. With this feature, an integer can be shown as a fixed point number.</p> <p><b>Example:</b></p> <table border="1"> <thead> <tr> <th>Display Type</th> <th>Total Digits</th> <th>Fractional Digits</th> <th>Justification</th> <th>Monitored Value</th> <th>Displayed Value</th> </tr> </thead> <tbody> <tr> <td>32-bit Floating Point</td> <td>4</td> <td>2</td> <td>Zero Suppress</td> <td>12.34</td> <td>12.34</td> </tr> <tr> <td>32-bit Floating Point</td> <td>4</td> <td>2</td> <td>Zero Suppress</td> <td>123.4</td> <td>23.40</td> </tr> <tr> <td>16-bit Signed Decimal</td> <td>5</td> <td>2</td> <td>Zero Suppress</td> <td>12345</td> <td>123.45</td> </tr> <tr> <td>16-bit Signed Decimal</td> <td>5</td> <td>2</td> <td>Zero Suppress</td> <td>-5</td> <td>-0.05</td> </tr> </tbody> </table>	Display Type	Total Digits	Fractional Digits	Justification	Monitored Value	Displayed Value	32-bit Floating Point	4	2	Zero Suppress	12.34	12.34	32-bit Floating Point	4	2	Zero Suppress	123.4	23.40	16-bit Signed Decimal	5	2	Zero Suppress	12345	123.45	16-bit Signed Decimal	5	2	Zero Suppress	-5	-0.05
Display Type	Total Digits	Fractional Digits	Justification	Monitored Value	Displayed Value																										
32-bit Floating Point	4	2	Zero Suppress	12.34	12.34																										
32-bit Floating Point	4	2	Zero Suppress	123.4	23.40																										
16-bit Signed Decimal	5	2	Zero Suppress	12345	123.45																										
16-bit Signed Decimal	5	2	Zero Suppress	-5	-0.05																										
Alignment	The alignment of the displayed value. There are three types of alignment: Left, Center, and Right.																														
Justification	<p>The justification of the displayed value. There are three types of justification:</p> <table border="1"> <thead> <tr> <th>Option</th> <th>Description</th> </tr> </thead> <tbody> <tr> <td>Zero Suppress</td> <td>The leading digits will not display when they are 0.</td> </tr> <tr> <td>Leading Zeros</td> <td>All digits will display.</td> </tr> <tr> <td>Leading Spaces</td> <td>The leading digits will display as blank character when they are 0.</td> </tr> </tbody> </table>	Option	Description	Zero Suppress	The leading digits will not display when they are 0.	Leading Zeros	All digits will display.	Leading Spaces	The leading digits will display as blank character when they are 0.																						
Option	Description																														
Zero Suppress	The leading digits will not display when they are 0.																														
Leading Zeros	All digits will display.																														
Leading Spaces	The leading digits will display as blank character when they are 0.																														



## 7.2.4. Advanced Settings

This section describes how to define the advanced settings for a numeric display. The following is an example of the Advanced page of the Numeric Display property sheet.

The following table describes each property in the Advanced page.

Property		Description	
Scaling	<Check Box>	Check this option if you want the value of the monitored variable to be displayed in a scaled manner. The following is the scaling formula. $\text{Displayed Value} = \text{Monitored Value} * \text{Gain} + \text{Offset}$ <b>Note:</b> The <i>Gain</i> and <i>Offset</i> are 32-bit floating point numbers. They have at most 6 significant digits. The rounding and truncation may happen.	
	Gain	The <i>Gain</i> of the scaling formula.	
	Offset	The <i>Offset</i> of the scaling formula.	
Range Display	<Check Box>	Check this option if you want the numeric display to display the value with different color when the value is below the specified low limit or over the specified high limit.	
	Variable Range	Check this option if the low limit and high limit are specified by the designated variables at runtime.	
	Low Limit	Specifies the low limit when the Variable Range is not selected. When the Variable Range is selected, this property specifies the variable that stores the low limit at runtime. Click  to enter an address. Click  to select a tag.	
	High Limit	Specifies the high limit when the Variable Range is not selected. When the Variable Range is selected, this property specifies the variable that stores the high limit at runtime. Click  to enter an address. Click  to select a tag.	
	High Color	Text Color	The text color for the high limit.
		BG Color	The shape's BG color for the high limit.
	Low Color	Text Color	The text color for the low limit.
BG Color		The shape's BG color for the low limit.	





## 7.3. Advanced Numeric Displays

### 7.3.1. Advanced Features

An advanced numeric display provides the following advanced features:

- 1) You can specify an arithmetic expression or a macro for the object to calculate the display value.
- 2) You can specify an arithmetic expression or a macro for the object to convert the operator entered value to the output value.
- 3) You can specify up to 10 ranges for the object to display.

### 7.3.2. Operation Options

The following operation options can be added to an advanced numeric display. Select and set the options in the Advanced Numeric Display property sheet.

Options	Description
Range Display	The advanced numeric display can support up to 10 fixed ranges or 3 variable ranges. You can define the text color, the BG color, and the lower bound for each range. At runtime, the advanced numeric display uses the color settings for the range to which the value belongs to display the value.
Range Check	The advanced numeric display will verify the entered value according to the specified maximum and minimum. If the entered value is not within the allowable range, the value will not be output. Select and set this option in the Range page. <b>Note:</b> If the output expression or the output macro is defined, the converted value stored in the variable \$W instead of the entered value is verified.
Touch Operation Control	You can enable and disable the touch operation of the advanced numeric display by the specified bit or the current user level. Select and set this option in the Advanced page.
Timeout	The keypad displayed for the advanced numeric display will be closed and the data entry operation will be cancelled after the keypad receives no input for the specified time period.
Notification	The advanced numeric display will notify the specified bit when it finishes outputting the entered value. Select and set this option in the Advanced page.
Operator Confirmation	The Confirmation box will be displayed when a value is entered for the advanced numeric display. If the operator selects "Yes" in the Confirmation box, the advanced numeric display will write the entered value to the specified variable. If the operator selects "No" or the operator does not respond within the specified time period (Maximum Waiting Time), the advanced numeric display will cancel the data entry operation. Select and set this option in the Advanced page.
Operation Logging	The time, the entered value, and the predefined operation message will be recorded when the advanced numeric display outputs the entered value. Select and set this option in the Advanced page.
Visibility Control	You can show and hide the advanced numeric display by the specified bit or the current user level. Select and set this option in the Visibility page.



### 7.3.3. Settings

You can complete all the settings of an advanced numeric display in the Advanced Numeric Display property sheet. This sheet contains the following seven pages. Some of the pages appear only when they are needed.

- **General**

Described in [Section 7.3.4.](#)

- **Range**

Described in [Section 7.3.5](#)

- **Advanced**

Described in [Section 4.4.5.](#)

- **Visibility**

Described in [Section 4.4.6.](#)

- **External Label**

Described in [Section 4.3.8.](#)

- **Display Macro**

Described in [Section 14.2.6.](#)

- **Output Macro**

Described in [Section 14.2.6.](#)



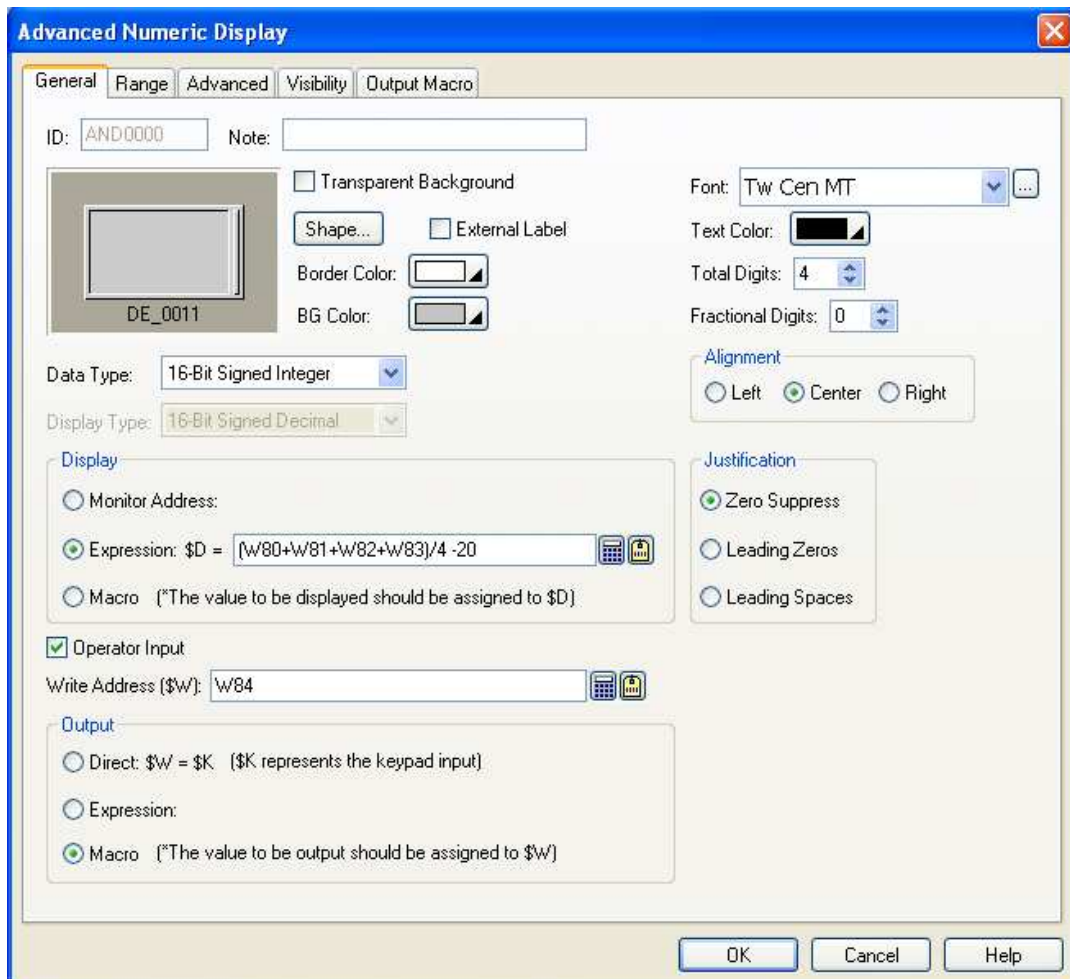

### 7.3.4. General Settings

This section describes how to define the general settings for an advanced numeric display. The following is an example of the General page of the Advanced Numeric Display property sheet.



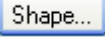





The following table describes each property in the General page.

Property		Description																								
ID		The object's identifier. It is generated when the object is created. The identifier is unique within the screen where the object is on. The format of the ID's for the advanced numeric displays is ANDnnnn.																								
Note		You can type a note for the object.																								
Transparent Background		Select this option if you want the object to have a transparent background.																								
Shape settings		For details about the following properties, see <a href="#">Section 4.3.4 Setting up the Shape of an Object</a> ,  , Border Color, BG Color																								
External Label		Check this option if you want the object to have an external label. Set up the external label in the External Label page.																								
Data Type		The data type for the variables, arithmetic expressions, macros of the advanced numeric display. The supported data types include: 16-Bit Unsigned Integer, 32-Bit Unsigned Integer, 16-Bit Signed Integer, 32-Bit Signed Integer, 16-Bit BCD, 32-Bit BCD, 32-Bit Floating Point, 16-Bit Signed BCD (LMB), 32-Bit Signed BCD (LMB), 16-Bit Signed BCD (LMD), and 32-Bit Signed BCD (LMD).																								
Display Type		<p>The display type for the advanced numeric display. The following table shows the available display types for each data type.</p> <table border="1"> <thead> <tr> <th>Data Type</th> <th>Available Display Types</th> </tr> </thead> <tbody> <tr> <td>16-Bit Unsigned Integer</td> <td>16-Bit Unsigned Decimal, 16-Bit Hexadecimal, 16-Bit Octal</td> </tr> <tr> <td>32-Bit Unsigned Integer</td> <td>32-Bit Unsigned Decimal, 32-Bit Hexadecimal, 32-Bit Octal</td> </tr> <tr> <td>16-Bit Signed Integer</td> <td>16-Bit Signed Decimal</td> </tr> <tr> <td>32-Bit Signed Integer</td> <td>32-Bit Signed Decimal</td> </tr> <tr> <td>16-Bit BCD</td> <td>16-Bit Unsigned Decimal</td> </tr> <tr> <td>32-Bit BCD</td> <td>32-Bit Unsigned Decimal</td> </tr> <tr> <td>32-Bit Floating Point</td> <td>32-Bit Floating Point</td> </tr> <tr> <td>16-Bit Signed BCD (LMB)</td> <td>16-Bit Signed Decimal</td> </tr> <tr> <td>32-Bit Signed BCD (LMB)</td> <td>32-Bit Signed Decimal</td> </tr> <tr> <td>16-Bit Signed BCD (LMD)</td> <td>16-Bit Signed Decimal</td> </tr> <tr> <td>32-Bit Signed BCD (LMD)</td> <td>32-Bit Signed Decimal</td> </tr> </tbody> </table>	Data Type	Available Display Types	16-Bit Unsigned Integer	16-Bit Unsigned Decimal, 16-Bit Hexadecimal, 16-Bit Octal	32-Bit Unsigned Integer	32-Bit Unsigned Decimal, 32-Bit Hexadecimal, 32-Bit Octal	16-Bit Signed Integer	16-Bit Signed Decimal	32-Bit Signed Integer	32-Bit Signed Decimal	16-Bit BCD	16-Bit Unsigned Decimal	32-Bit BCD	32-Bit Unsigned Decimal	32-Bit Floating Point	32-Bit Floating Point	16-Bit Signed BCD (LMB)	16-Bit Signed Decimal	32-Bit Signed BCD (LMB)	32-Bit Signed Decimal	16-Bit Signed BCD (LMD)	16-Bit Signed Decimal	32-Bit Signed BCD (LMD)	32-Bit Signed Decimal
Data Type	Available Display Types																									
16-Bit Unsigned Integer	16-Bit Unsigned Decimal, 16-Bit Hexadecimal, 16-Bit Octal																									
32-Bit Unsigned Integer	32-Bit Unsigned Decimal, 32-Bit Hexadecimal, 32-Bit Octal																									
16-Bit Signed Integer	16-Bit Signed Decimal																									
32-Bit Signed Integer	32-Bit Signed Decimal																									
16-Bit BCD	16-Bit Unsigned Decimal																									
32-Bit BCD	32-Bit Unsigned Decimal																									
32-Bit Floating Point	32-Bit Floating Point																									
16-Bit Signed BCD (LMB)	16-Bit Signed Decimal																									
32-Bit Signed BCD (LMB)	32-Bit Signed Decimal																									
16-Bit Signed BCD (LMD)	16-Bit Signed Decimal																									
32-Bit Signed BCD (LMD)	32-Bit Signed Decimal																									
Display	Monitor Address	<p>Select this option so the advanced numeric display will monitor the variable specified in the Monitor Address field and display its value. When this option is selected, you need to specify the monitored variable.</p> <p>Click  to enter an address for this field. Click  to select a tag for this field.</p>																								
	Expression	<p>Select this option so the advanced numeric display will display the result of the arithmetic expression specified in the Expression field. When this option is selected, you need to specify the arithmetic expression that calculates the value to be displayed.</p> <p>Click  to enter an address for this field. Click  to select a tag for this field.</p>																								
	Macro	Select this option so the advanced numeric display will run the macro defined in the Display Macro page before displaying the value of the internal variable \$D. The macro can decide the value to be displayed by saving the desired value in the internal variable \$D.																								
Operator Input		Select this option so the advanced numeric display will allow the operator to enter values for it.																								

Continued



Property		Description																																																												
Write Address		Specifies the destination variable where the entered value will be written to when the Operator Input is selected. Click  to enter an address for this field. Click  to select a tag for this field.																																																												
Output	Direct	Select this option so the advanced numeric display will write the entered value to the destination variable specified in the Write Address field directly.																																																												
	Expression	Select this option so the advanced numeric display will write the result of the arithmetic expression specified in the Expression field. When this option is selected, you need to specify the arithmetic expression that calculates the value to be output. To use the entered value as an operand in the expression, specify the internal variable \$K for the entered value. Click  to enter an address for this field. Click  to select a tag for this field.																																																												
	Macro	Select this option so the advanced numeric display will run the macro defined in the Output Macro page before writing the value of the internal variable \$W to the destination variable. The macro can decide the value to be output by saving the desired value in the internal variable \$W. To use the entered value in macro commands as a parameter, specify the internal variable \$K for the entered value.																																																												
Font		The font of the displayed value.																																																												
Text Color		The color of the displayed value.																																																												
Total Digits		The number of digits to be displayed. <b>Note:</b> This property applies to the display of the initial value, the allowable minimum, and the allowable maximum on the numeric keypad.																																																												
Fractional Digits		<p>When the Display Type is 32-bit Floating Point, this property specifies the number of fractional digits to be displayed.</p> <p>When the Display Type is not 32-bit Floating Point, this property specifies not only the number of fractional digits to be displayed but also the number of least significant digits to be displayed as the fractional part. With this feature, an integer can be shown and entered as a fixed point number. When the Fractional Digits is nonzero, say N, the entered value will be converted to an integer according to the following formula before being output.</p> <p>Output Value = Entered Value * (Nth power of 10)</p> <p>Example 1:</p> <table border="1"> <thead> <tr> <th>Display Type</th> <th>Total Digits</th> <th>Fractional Digits</th> <th>Justification</th> <th>Monitored Value</th> <th>Displayed Value</th> </tr> </thead> <tbody> <tr> <td>32-bit Floating Point</td> <td>4</td> <td>2</td> <td>Zero Suppress</td> <td>12.34</td> <td>12.34</td> </tr> <tr> <td>32-bit Floating Point</td> <td>4</td> <td>2</td> <td>Zero Suppress</td> <td>123.4</td> <td>23.40</td> </tr> <tr> <td>16-bit Signed Decimal</td> <td>5</td> <td>2</td> <td>Zero Suppress</td> <td>12345</td> <td>123.45</td> </tr> <tr> <td>16-bit Signed Decimal</td> <td>5</td> <td>2</td> <td>Zero Suppress</td> <td>-5</td> <td>-0.05</td> </tr> </tbody> </table> <p>Example 2:</p> <table border="1"> <thead> <tr> <th>Display Type</th> <th>Total Digits</th> <th>Fractional Digits</th> <th>Entered Value</th> <th>Output Value</th> </tr> </thead> <tbody> <tr> <td>32-bit Floating Point</td> <td>4</td> <td>2</td> <td>12.34</td> <td>12.34</td> </tr> <tr> <td>32-bit Floating Point</td> <td>4</td> <td>2</td> <td>123.4</td> <td>Error!</td> </tr> <tr> <td>16-bit Signed Decimal</td> <td>5</td> <td>2</td> <td>123.45</td> <td>12345</td> </tr> <tr> <td>16-bit Signed Decimal</td> <td>5</td> <td>2</td> <td>-0.05</td> <td>-5</td> </tr> <tr> <td>16-bit Signed Decimal</td> <td>5</td> <td>2</td> <td>3</td> <td>300</td> </tr> </tbody> </table> <p><b>Note:</b> This property applies to the display of the initial value, the allowable minimum, and the allowable maximum on the numeric keypad.</p>	Display Type	Total Digits	Fractional Digits	Justification	Monitored Value	Displayed Value	32-bit Floating Point	4	2	Zero Suppress	12.34	12.34	32-bit Floating Point	4	2	Zero Suppress	123.4	23.40	16-bit Signed Decimal	5	2	Zero Suppress	12345	123.45	16-bit Signed Decimal	5	2	Zero Suppress	-5	-0.05	Display Type	Total Digits	Fractional Digits	Entered Value	Output Value	32-bit Floating Point	4	2	12.34	12.34	32-bit Floating Point	4	2	123.4	Error!	16-bit Signed Decimal	5	2	123.45	12345	16-bit Signed Decimal	5	2	-0.05	-5	16-bit Signed Decimal	5	2	3	300
Display Type	Total Digits	Fractional Digits	Justification	Monitored Value	Displayed Value																																																									
32-bit Floating Point	4	2	Zero Suppress	12.34	12.34																																																									
32-bit Floating Point	4	2	Zero Suppress	123.4	23.40																																																									
16-bit Signed Decimal	5	2	Zero Suppress	12345	123.45																																																									
16-bit Signed Decimal	5	2	Zero Suppress	-5	-0.05																																																									
Display Type	Total Digits	Fractional Digits	Entered Value	Output Value																																																										
32-bit Floating Point	4	2	12.34	12.34																																																										
32-bit Floating Point	4	2	123.4	Error!																																																										
16-bit Signed Decimal	5	2	123.45	12345																																																										
16-bit Signed Decimal	5	2	-0.05	-5																																																										
16-bit Signed Decimal	5	2	3	300																																																										

Continued



Property	Description								
Alignment	The alignment of the displayed value. There are three types of alignment: Left, Center, and Right.								
Justification	The justification of the displayed value. There are three types of justification:								
	<table border="1"> <thead> <tr> <th>Option</th> <th>Description</th> </tr> </thead> <tbody> <tr> <td>Zero Suppress</td> <td>The leading digits will not display when they are 0.</td> </tr> <tr> <td>Leading Zeros</td> <td>All digits will display.</td> </tr> <tr> <td>Leading Spaces</td> <td>The leading digits will display as blank character when they are 0.</td> </tr> </tbody> </table>	Option	Description	Zero Suppress	The leading digits will not display when they are 0.	Leading Zeros	All digits will display.	Leading Spaces	The leading digits will display as blank character when they are 0.
	Option	Description							
	Zero Suppress	The leading digits will not display when they are 0.							
Leading Zeros	All digits will display.								
Leading Spaces	The leading digits will display as blank character when they are 0.								





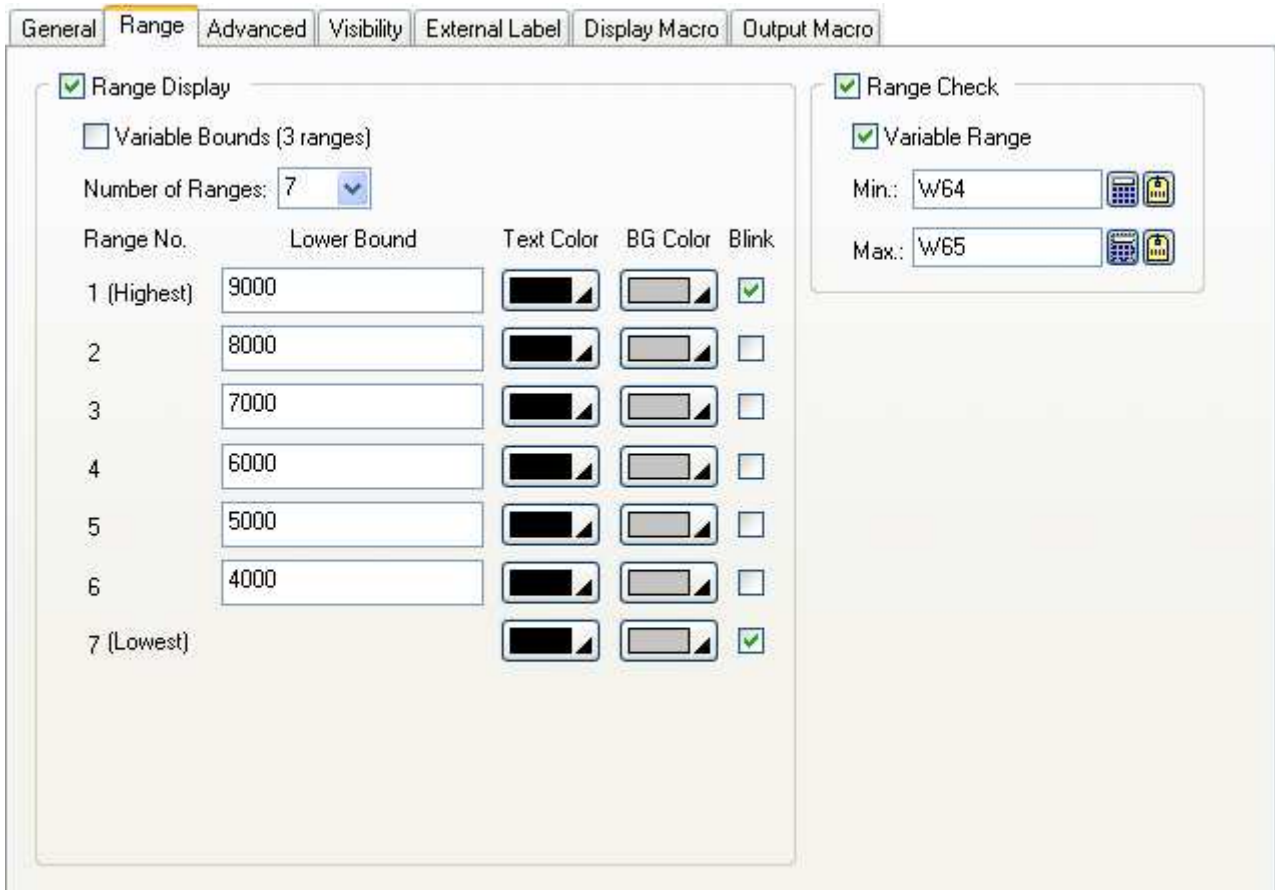



### 7.3.5. Range Settings

This section describes how to define the range settings for an advanced numeric display. The following is an example of the Range page of the Advanced Numeric Display property sheet.



The following table describes each property in the Range page.



Property		Description	
Range Display	Range Display	Check this option if you want the advanced numeric display to support the range display. The advanced numeric display can support up to 10 fixed ranges or 3 variable ranges. You can define the text color, the BG color, and the lower bound for each range. At runtime, the monitored value will be displayed with the color setting for the range that the monitored value belongs.	
	Variable Bound (3 ranges)	Check this option so the lower bounds of range 1 and range 2 will be determined at runtime by the variables specified in the Lower Bound fields for Range 1 and Range 2. The advanced numeric display supports 3 ranges when the Variable Bound is selected. When the Variable Bound is not selected, the advanced numeric display can support up to 10 ranges. You need to specify the lower bounds for every range except the lowest range.	
	Number of Ranges	The number of ranges that the advanced numeric display supports.	
	Range 1 (Highest)	Lower Bound	Specifies the lower bound of range 1 when the Variable Bound is not selected. When the Variable Bound is selected, this property specifies the variable whose value will be the lower bound of range 1 at runtime. Click  to enter an address for this field. Click  to select a tag for this field.
		Text Color	The text color for range 1.
		BG Color	The shape's BG color for range 1.
		Blink	Check the item when you want the display blinks for range 1.
	Range 2	Lower Bound	Specifies the lower bound of range 2 when the Variable Bound is not selected. When the Variable Bound is selected, this property specifies the variable whose value will be the lower bound of range 2 at runtime. Click  to enter an address for this field. Click  to select a tag for this field.
		Text Color	The text color for range 2.
		BG Color	The shape's BG color for range 2.
		Blink	Check the item when you want the display blinks for range 2.
	Range 3 to Range 10	Lower Bound	Specifies the lower bound of the corresponding range when the range is not the lowest range.
		Text Color	The text color for the corresponding range.
BG Color		The shape's BG color for the corresponding range.	
Blink		Check the item when you want the display blinks for the corresponding range	
Range Check	Range Check	Check this option if you want the advanced numeric display to verify the entered value according to the specified minimum and maximum. If the entered value is not within the allowable range, the entered value will not be output. <b>Note:</b> If the output expression or the output macro is defined, the converted value stored in the variable \$W instead of the entered value is verified.	
	Variable Range	Check this option so the minimum and maximum will be determined at runtime by the variables specified in the Minimum and Maximum fields.	
	Min.	Specifies the minimum when the Variable Range is not selected. When the Variable Range is selected, this property specifies the variable whose value is the minimum. Click  to enter an address for this field. Click  to select a tag for this field.	
	Max.	Specifies the maximum when the Variable Range is not selected. When the Variable Range is selected, this property specifies the variable whose value is the maximum. Click  to enter an address for this field. Click  to select a tag for this field.	





## 7.4. Character Entries

You can enter a string for a variable using a character entry. If the target panel is a PC, you can also use this object to enter a Unicode string.

### 7.4.1. Operation Options

The following operation options can be added to a character entry. Select and set up the options in the Character Entry property sheet.

Option	Description
Touch Operation Control	You can enable or disable the touch operation of the object by the specified bit or by the current user level. Select and set up this option in the Advanced page.
Timeout	If the keypad for the data entry receives no input for the specified time period, the data entry operation will be cancelled.
Notification	The Object will notify the specified bit of a successful data entry operation. Select and set up this option in the Advanced page.
Operator Confirmation	When a character string is entered by the operator, the Confirmation box will display for the operator confirmation. If the operator selects "Yes", the object will write the entered data to the specified variable. If the operator selects "No" or the operator does not respond within the specified time period (Maximum Waiting Time), the data entry operation will be cancelled. Select and set up this option in the Advanced page.
Operation Logging	The entered character string and the time of the data entry will be recorded. Select and set up this option in the Advanced page.
Visibility Control	You can show or hide the object by the specified bit or by the current user level. Select and set up this option in the Visibility page.

### 7.4.2. Settings

You can complete all the settings of a character entry in the Character Entry property sheet. This sheet contains the following four pages. Some of the pages appear only when they are needed.

- **General**

Described in [Section 7.4.3.](#)

- **Advanced**

Described in [Section 7.4.4.](#)

- **Visibility**

Described in [Section 4.4.6.](#)

- **External Label**

Described in [Section 4.3.8.](#)

### 7.4.3. General Settings

This section describes how to define the general settings for the character entries. The following is an example of the General page of the Character Entry property sheet.

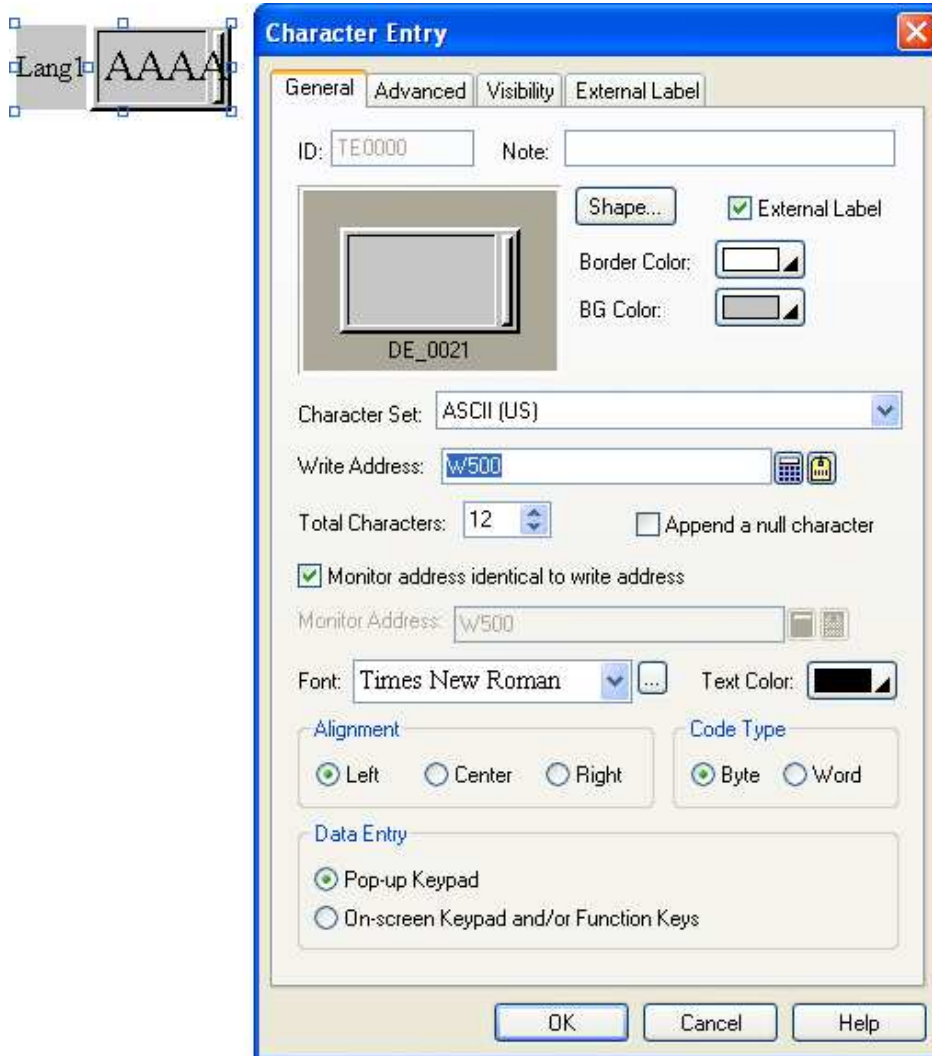



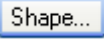

The following table describes each property in the General page.

Property	Description
ID	The object's identifier. It is generated when the object is created. The identifier is unique within the screen where the object is on. The format of the ID's for the Character entries is TEnnnn.
Note	You can type a note for the object.
Shape settings	For details about the following properties, see <a href="#">Section 4.3.4 Setting up the Shape of an Object</a> .  , Border Color, BG Color
External Label	Check this option if you want the object to have an external label. Set up the external label in the External Label page.

Continued





Property	Description								
Character Set	<p>Select one of the following three character sets to encode characters into a stream of code units</p> <table border="1"> <thead> <tr> <th>Character Set</th> <th>Description</th> </tr> </thead> <tbody> <tr> <td>ASCII (US)</td> <td>Defines 128 characters. And uses 8 or 16 bits per character.</td> </tr> <tr> <td>ISO-8859-1 (Western European)</td> <td>Covers mostly Western European languages. And uses 8 or 16 bits per character.</td> </tr> <tr> <td>Unicode</td> <td>Available only when the target panel is a PC. Each character occupies one word and the code is Unicode.</td> </tr> </tbody> </table>	Character Set	Description	ASCII (US)	Defines 128 characters. And uses 8 or 16 bits per character.	ISO-8859-1 (Western European)	Covers mostly Western European languages. And uses 8 or 16 bits per character.	Unicode	Available only when the target panel is a PC. Each character occupies one word and the code is Unicode.
Character Set	Description								
ASCII (US)	Defines 128 characters. And uses 8 or 16 bits per character.								
ISO-8859-1 (Western European)	Covers mostly Western European languages. And uses 8 or 16 bits per character.								
Unicode	Available only when the target panel is a PC. Each character occupies one word and the code is Unicode.								
Write Address	<p>Specifies the destination variable where the entered character string will be written to.</p> <p>Click  to enter an address for this field. Click  to select a tag for this field.</p>								
Total Characters	Specifies the number of characters that the Character entry can display and the destination variable can receive.								
Append a null character	Check this option so the Character entry will always append a null character to the entered character string before outputting it.								
Monitor Address identical to Write Address	Specifies that the monitored variable is the same as the destination variable. With this item checked, you don't need to specify the monitored variable in the Monitor Address field.								
Monitor Address	<p>Specifies the monitored variable.</p> <p>Click  to enter an address for this field. Click  to select a tag for this field.</p>								
Font	The font of the displayed string.								
Text Color	The color of the displayed string.								
Alignment	The alignment of the displayed value. There are three types of alignment: Left, Center, and Right.								
Code Type	<p>Select one of the following two code types.</p> <table border="1"> <thead> <tr> <th>Type</th> <th>Description</th> </tr> </thead> <tbody> <tr> <td>Byte</td> <td>Each character occupies one byte.</td> </tr> <tr> <td>Word</td> <td>Each character occupies one word.</td> </tr> </tbody> </table> <p>Available only when the character set is ASCII (US) or ISO-8859-1 (Western European).</p>	Type	Description	Byte	Each character occupies one byte.	Word	Each character occupies one word.		
Type	Description								
Byte	Each character occupies one byte.								
Word	Each character occupies one word.								
Data Entry	<p>Specifies how to enter a character string for the Character entry at runtime. There are two options:</p> <table border="1"> <thead> <tr> <th>Option</th> <th>Description</th> </tr> </thead> <tbody> <tr> <td>Pop-up Keypad</td> <td>You can bring up the keypad by pressing the Character entry and enter a character string with the keypad.</td> </tr> <tr> <td>On-screen Keypad and/or Function Keys</td> <td>You can move the cursor by using the function buttons with the operation of Select Next Data Entry Object or Select Previous Data Entry Object to select the Character entry. If there is an on-screen keypad you can enter a character string for the Character entry with that keypad.</td> </tr> </tbody> </table> <p><b>Note:</b> When On-screen Keypad and/or Function Keys option is selected, you can only enter a character string for the Character entry with the input focus. To set the input focus on the corresponding object, you need to click the object first.</p>	Option	Description	Pop-up Keypad	You can bring up the keypad by pressing the Character entry and enter a character string with the keypad.	On-screen Keypad and/or Function Keys	You can move the cursor by using the function buttons with the operation of Select Next Data Entry Object or Select Previous Data Entry Object to select the Character entry. If there is an on-screen keypad you can enter a character string for the Character entry with that keypad.		
Option	Description								
Pop-up Keypad	You can bring up the keypad by pressing the Character entry and enter a character string with the keypad.								
On-screen Keypad and/or Function Keys	You can move the cursor by using the function buttons with the operation of Select Next Data Entry Object or Select Previous Data Entry Object to select the Character entry. If there is an on-screen keypad you can enter a character string for the Character entry with that keypad.								



### 7.4.4. Advanced Settings

This section describes how to define the advanced settings for the character entries. The following is an example of the Advanced page.

The following table describes each property in the Advanced page.

Property		Description
Touch Operation Control	Enabled by Bit	Check this option so the touch operation of the Character entry will be enabled and disabled by the specified bit.
	Control Bit	Specifies the bit that enables and disables the touch operation. Click  to enter a bit address. Click  to select a bit tag.
	Enabling State	Specifies the state (On or Off) that enables the touch operation.
	Enabled by User Level	Check this item so the touch operation of the Character entry will be enabled and disabled by the current user level.
	Lowest Enabling User Level	Specifies the lowest user level that is required to enable the touch operation.
	Show Disabled Sign	Check this option so the touch operation disabled sign will be shown on the Character entry when the touch operation is disabled.
Timeout	Timeout	Check this option so the data entry will be cancelled if the numeric keypad does not receive any input within the specified time.
	Timeout Time	Specifies the maximum time that the numeric keypad will wait to get a new input. If there is no input within the specified time, the Character keypad will be closed and the data entry will be cancelled.

Continued



Property		Description						
Notification	Notification	Check this option so the Character entry will notify the specified bit after it finishes outputting the entered value to the destination variable.						
	Signal	Select one of the following signal for the notification: <table border="1" data-bbox="497 344 1447 477"> <thead> <tr> <th>Signal</th> <th>Description</th> </tr> </thead> <tbody> <tr> <td>Level</td> <td>Set the specified bit to the specified state.</td> </tr> <tr> <td>Pulse</td> <td>Send a positive pulse to the specified bit.</td> </tr> </tbody> </table>	Signal	Description	Level	Set the specified bit to the specified state.	Pulse	Send a positive pulse to the specified bit.
	Signal	Description						
	Level	Set the specified bit to the specified state.						
	Pulse	Send a positive pulse to the specified bit.						
Bit	Specifies the bit that receives the notification.							
State	Specifies the state (On or Off) that is used for the notification.							
Operator Confirmation	Operator Confirmation	Check this option if you want the operator to confirm what he/she enters for the numeric entry. The Confirmation box will be displayed when a value is entered for the Character entry. If the operator selects "Yes" in the Confirmation box, the numeric entry will write the entered value to the specified variable. If the operator selects "No" or the operator does not respond within the specified time period (Maximum Waiting Time), the Character entry will cancel the data entry operation.						
	Maximum Waiting Time	Specifies the maximum time that the Character entry will wait for the operator's confirmation. The data entry will be cancelled if the operator does not respond within this time.						
Operation Logging	Operation Logging	Check this option so the following three items will be recorded in the operation log when the Character entry outputs the entered value. There are three recorded items: 1) The time when the operation is performed 2) The entered Character 3) The predefined operation message						
	Message	Enter the operation message of the first language here.						
		Click this button to bring up the Operation Message dialog box that you can edit the operation message for all the languages.						



## 7.5. Character Displays

You can use a character display to display the string stored in a variable. This object can display Unicode string if the target panel is a PC.

**Note:** The difference between a character display and a text object is:

A character display is used to either display text, to request text, or to do both. The text of the Character display is not allowed to be set at design time but can easily be done at run time. You can specify the text by changing its defined variable.

A text object can be used to create a label at design time which is a short text that accompanies other control to indicate what it is used for. It can not be changed at run time.

### 7.5.1. Operation Options

The following operation option can be added to a character display. Select and set up the option in the Character Display property sheet.

Options	Description
Visibility Control	You can show or hide the Character display by the specified bit or by the current user level. Select and set up this option in the Visibility page.

### 7.5.2. Settings

You can complete all the settings of a character display in the Character Display property sheet. This sheet contains the following three pages. Some of the pages appear only when they are needed.

- **General**

Described in [Section 7.5.3.](#)

- **Visibility**

Described in [Section 4.4.6.](#)

- **External Label**

Described in [Section 4.3.8.](#)

### 7.5.3. General Settings

This section describes how to define the general settings for the character displays. The following is an example of the General page of the Character Display property sheet.

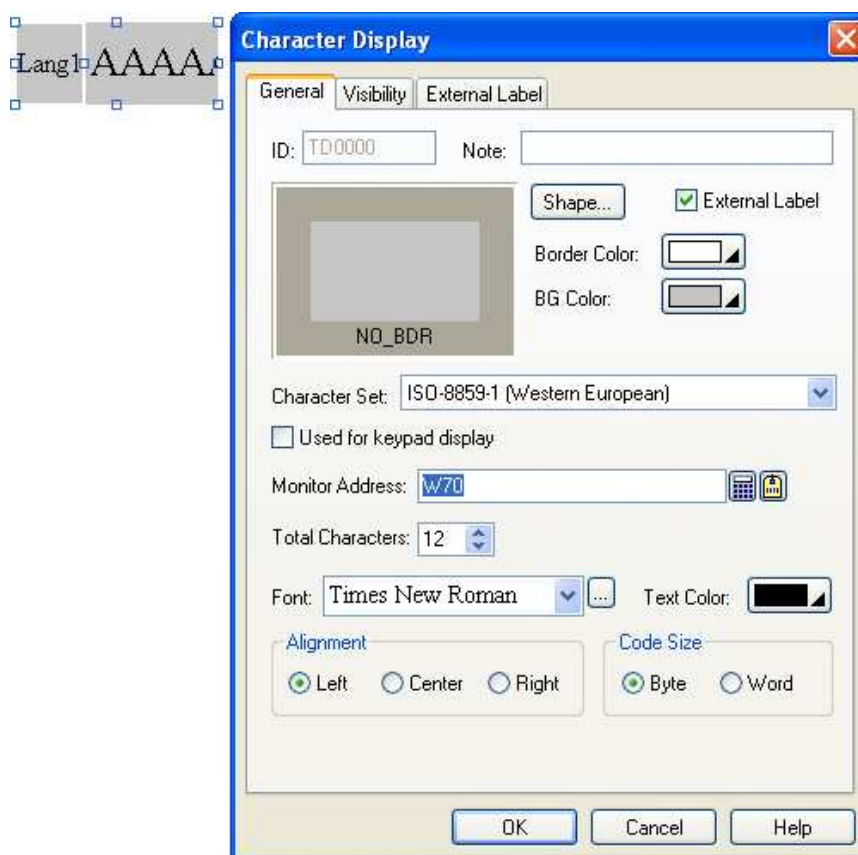

The following table describes each property in the General page.

Property	Description
ID	The object's identifier. It is generated when the object is created. The identifier is unique within the screen where the object is on. The format of the ID's for the Character displays is TDnnnn.
Note	You can type a note for the object.
Shape settings	For details about the following properties, see <a href="#">Section 4.3.4 Setting up the Shape of an Object</a> . , Border Color, BG Color
External Label	Check this option if you want the object to have an external label. Set up the external label in the External Label page.
Character Set	The types of character code of the string in the monitored variable. You can select ASCII(US) code or ISO-8859-1(Western European). If the target panel is a PC, the Unicode is also an option.
Used for keypad display	Check this option if the character display is used to display the input for a custom keypad.
Monitor Address	Specifies the monitored variable. Click  to enter an address for this field. Click  to select a tag for this field.
Total Characters	Specifies the number of characters that the Character display can display.
Font	The font of the displayed string.
Text Color	The color of the displayed string.
Alignment	The alignment of the displayed value. There are three types of alignment: Left, Center, and Right.
Code Size	The size of each character. You can select Byte or Word.

## 7.6. Time Displays

You can use a time display to show the time of the panel.

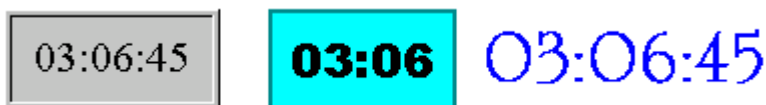

### 7.6.1. Settings

You can complete all the settings of a time display in the Time Display property sheet. The following is an example of the sheet.

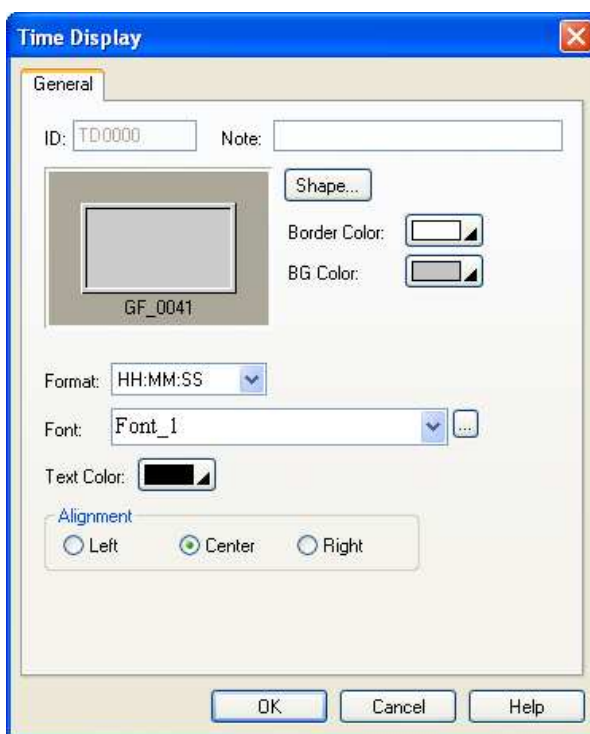

The following table describes each property in the General page.

Property	Description						
ID	The object's identifier. It is generated when the object is created. The identifier is unique within the screen where the object is on. The format of the ID's for the time displays is TDnnnn.						
Note	You can type a note for the object.						
Shape settings	For details about the following properties, see <a href="#">Section 4.3.4 Setting up the Shape of an Object.</a>  , Border Color, BG Color						
Format	The format of how the time is displayed. There are two kinds of format available. <table border="1" data-bbox="258 1762 1184 1919"> <thead> <tr> <th>Format</th> <th>Description</th> </tr> </thead> <tbody> <tr> <td>HH:MM</td> <td>HH: 00~23 (hour); MM: 00~59 (minute)</td> </tr> <tr> <td>HH:MM:SS</td> <td>HH: 00~23 (hour); MM: 00~59 (minute); SS: 00~59 (second)</td> </tr> </tbody> </table>	Format	Description	HH:MM	HH: 00~23 (hour); MM: 00~59 (minute)	HH:MM:SS	HH: 00~23 (hour); MM: 00~59 (minute); SS: 00~59 (second)
Format	Description						
HH:MM	HH: 00~23 (hour); MM: 00~59 (minute)						
HH:MM:SS	HH: 00~23 (hour); MM: 00~59 (minute); SS: 00~59 (second)						
Font	The font of the text.						
Text Color	The color of the text.						
Alignment	The alignment of the text in the object. There are three kinds of alignment available: Left, Center, and Right.						

## 7.7. Date Displays

You can use a date display to show the date of the panel.



### 7.7.1. Settings

You can complete all the settings of a date display in the Date Display property sheet. The following is an example of the sheet.

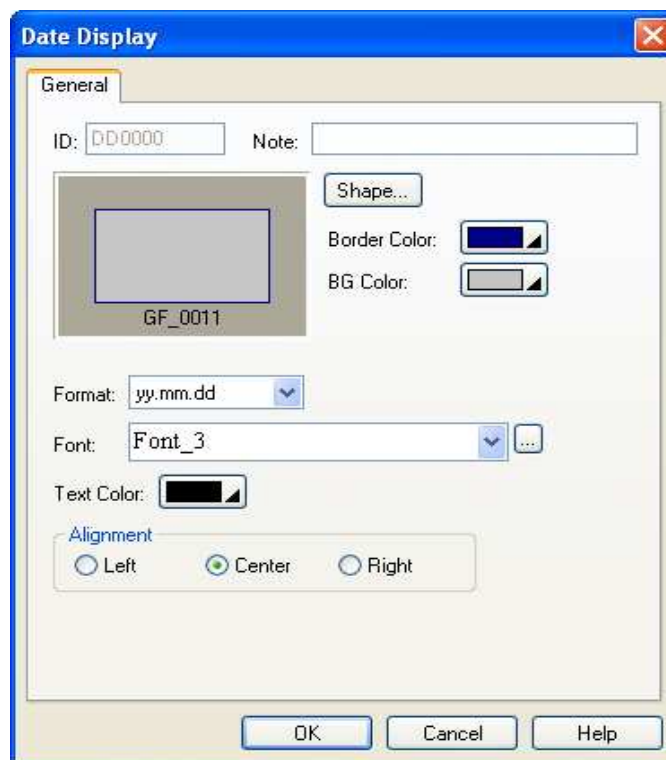

The following table describes each property in the General page.

Property	Description
ID	The object's identifier. It is generated when the object is created. The identifier is unique within the screen where the object is on. The format of the ID's for the date displays is DDnnnn.
Note	You can type a note for the object.
Shape settings	For details about the following properties, see <a href="#">Section 4.3.4 Setting up the Shape of an Object</a> . <a href="#">Shape...</a> , Border Color, BG Color
Format	The format of how the date is displayed. There are 12 kinds of format available: dd/mm/yy, mm/dd/yy, yy/mm/dd, dd.mm.yy, mm.dd.yy, yy.mm.dd, dd-mm-yy, mm-dd-yy, yy-mm-dd, dd-MMM-yy, MMM-dd-yy, and yy-MMM-dd. To change the date display format, choose one from the drop-down table. <b>Note:</b> dd: 01~31 (day); mm: 01~12 (month); yy: 00~99 (year); MMM: JAN~DEC (month)
Font	The font of the text.
Text Color	The color of the text.
Alignment	The alignment of the text in the object. There are three kinds of alignment available: Left, Center, and Right.

## 7.8. Day-of-week Displays

You can use a day-of-week display to show the day-of-week of the panel.



### 7.8.1. Settings

You can complete all the settings of a day-of-week display in the Day-of-week Display property sheet. This sheet contains the following two pages.

- **General**  
Described in [Section 7.8.2.](#)
- **Text**  
Described in [Section 4.3.6.](#)

**Note:** When using the Text page to specify the text for each day, note that state 0 corresponds to Sunday, state 1 corresponds to Monday, and so on.

### 7.8.2. General Settings

This section describes how to define the general settings for a day-of-week display. The following is an example of the General page of the Day-of-week property sheet.

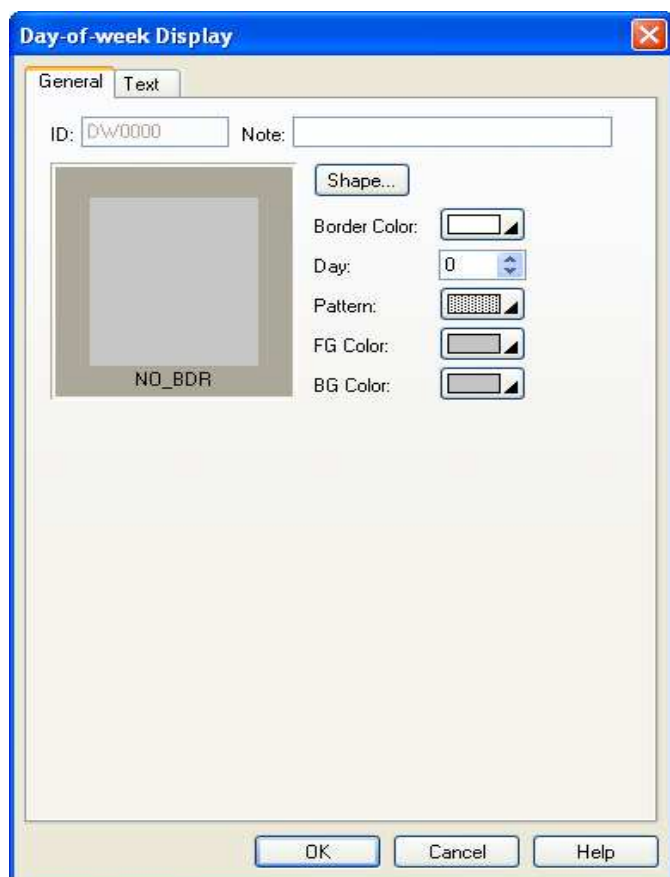

The following table describes each property in the General page.

Property	Description
ID	The object's identifier. It is generated when the object is created. The identifier is unique within the screen where the object is on. The format of the ID's for the day-of-week displays is DWnnnn.
Note	You can type a note for the object.
Shape settings	For details about the following properties, see <a href="#">Section 4.3.4 Setting up the Shape of an Object.</a>  , Border Color, Pattern, FG Color, BG Color
Day	Select a day from 0 to 6 so you can view and set the Pattern, FG Color, and BG Color for that day. Day 0 corresponds to Sunday; day 1 corresponds to Monday, and so on.



## CHAPTER 8

# GRAPHS AND CHARTS

<b>8.1. Bar Graphs</b> .....	<b>1</b>
8.1.1. Basic Operations.....	1
8.1.2. Operation Options.....	2
8.1.3. Settings.....	3
8.1.4. General Settings .....	4
8.1.5. Forward and Backward Marker Settings .....	6
8.1.6. Advanced Settings .....	8
<b>8.2. Meters</b> .....	<b>9</b>
8.2.1. Basic Operations.....	9
8.2.2. Operation Options.....	10
8.2.3. Settings.....	10
8.2.4. General Settings .....	11
8.2.5. Range Settings .....	14
<b>8.3. Circular Bar Graphs</b> .....	<b>15</b>
8.3.1. Basic Operations.....	15
8.3.2. Operation Options.....	16
8.3.3. Settings.....	16
8.3.4. General Settings .....	17
<b>8.4. Line Charts</b> .....	<b>19</b>
8.4.1. Basic Operations.....	19
8.4.2. Operation Options.....	20
8.4.3. Settings.....	20
8.4.4. General Settings .....	21
8.4.5. Pen Settings.....	26
8.4.6. Axis Settings .....	27
<b>8.5. Scatter Charts</b> .....	<b>29</b>
8.5.1. Basic Operations.....	29
8.5.2. Operation Options.....	29
8.5.3. Settings.....	30
8.5.4. General Settings .....	31
8.5.5. Pen Settings.....	35

## 8.1. Bar Graphs

### 8.1.1. Basic Operations

A bar graph shows the value of a monitored variable by displaying a bar with variable length. When the value of the variable increases or decreases, the length of the bar increases or decreases accordingly. A bar graph can have a scale and the scale enables you to measure the length of the bar and read the current value for the monitored variable.

There are two bar types that a bar graph can have: a polar bar and a bipolar bar. The polar bar can only move one end, but the bipolar bar can move both ends. The bar and the scale can be displayed in any of the following four directions:

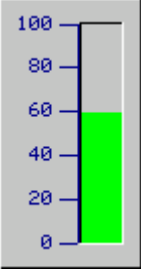
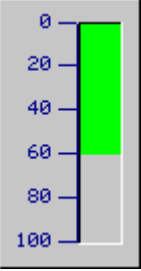
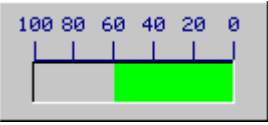
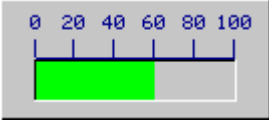
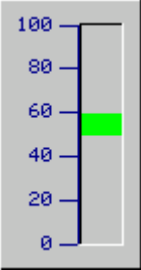
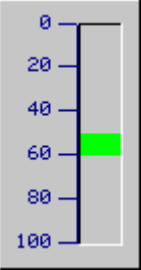
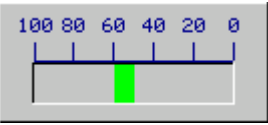
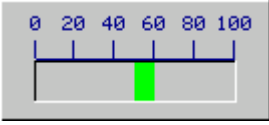
Type	Upward	Downward	Leftward	Rightward
<b>Polar Bar</b> ( Monitored Value = 60 )				
<b>Bipolar Bar</b> ( Monitored Value = 60 Middle Point = 50 )				

A bar graph can also have scale, forward markers, backward markers and percentage display.

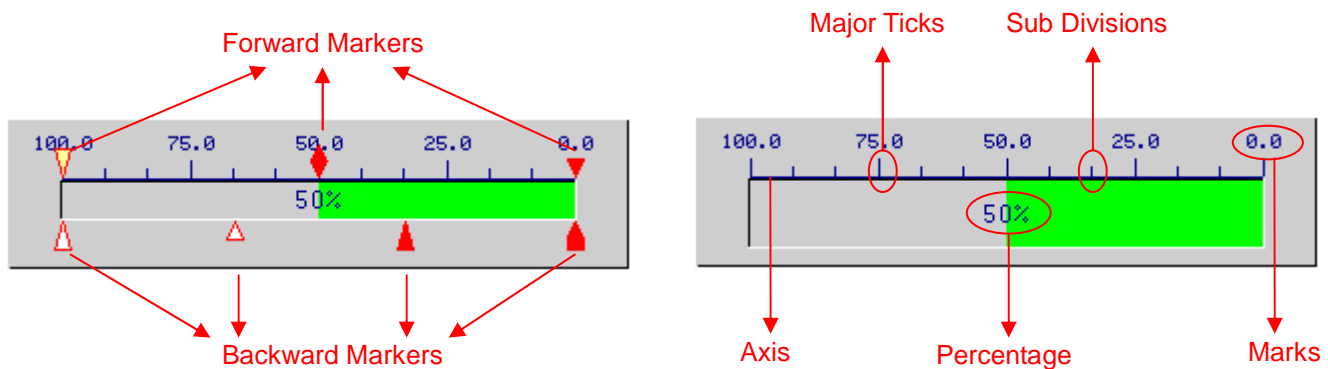

- Note:**
- The bar graph with bipolar bar does not have forward and backward markers.
  - If the bar graph is upward or downward, the scale and forward/backward markers will locate on the left or on the right.
  - If the bar graph is leftward or rightward, the scale and forward/backward markers will locate on the top or on the bottom.

### 8.1.2. Operation Options

The following operation options can be added to a bar graph to make it more informative. You need to select and set these options in the Bar Graph property sheet.

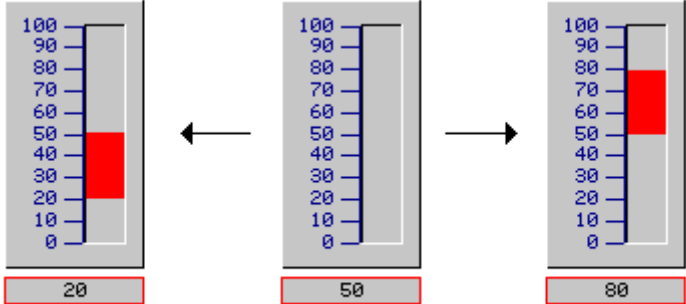
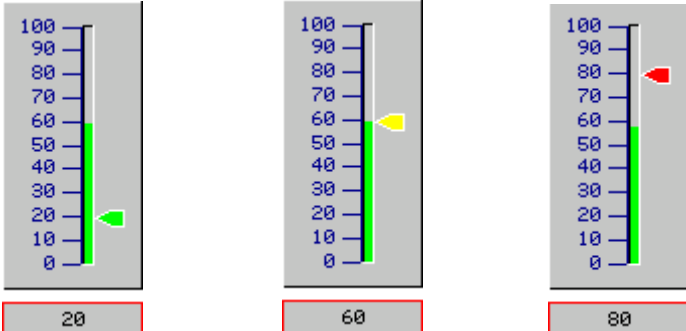
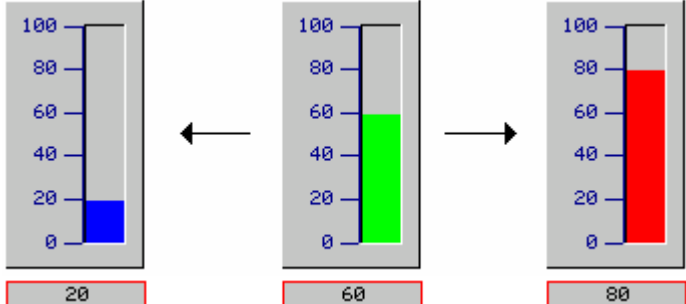
Options	Description
<b>Bipolar Bar</b>	<p>A bar graph can be configured to display the difference between the monitored value and a specified value which is called the middle point. The bar can move both ends, so it is called bipolar bar.</p>  <p style="text-align: center;"><b>Middle Point = 50</b></p> <p style="text-align: right;"><b>Monitored Value</b></p> <p>Select and set this option in the <a href="#">General page</a>.</p>
<b>Scale</b>	<p>A bar graph can have a scale. Select and set this option in the Scale page.</p>
<b>Forward / Backward Marker</b>	<p>The forward/ backward marker of a bar graph can have up to 12 marks. You may select equilateral triangle, triangle, diamond and cone as the marker. The actual number of marks and the value of each mark are specified at runtime by the forward/ backward marker control block. The position of a mark is determined by that mark's value. The color of a mark is determined by the comparison result between the monitored value and that mark's value.</p>  <p style="text-align: right;"><b>Monitored Value = 60</b></p> <p style="text-align: right;">The color of a mark:</p> <ul style="list-style-type: none"> <li>LT Color = Light Red</li> <li>EQ Color = Yellow</li> <li>GT Color = Light Green</li> </ul> <p style="text-align: right;"><b>Mark's Value</b></p> <p>Select and set Forward Marker option in the <a href="#">F. Marker page</a>.          Select and set Backward Marker option in the <a href="#">B. Marker page</a>.</p>
<b>Range Display</b>	<p>You can specify a low limit and a high limit for a bar graph. The limits can be constants or variables. At runtime, when the monitored value is equal to or below the low limit, the bar graph shows the bar with the FG color and the BG color set for the low limit. When the monitored value is equal to or over the high limit, the bar graph shows the bar with the FG color and the BG color set for the high limit.</p>  <p style="text-align: right;"><b>Low Limit = 20</b></p> <p style="text-align: right;"><b>High Limit = 80</b></p> <p style="text-align: right;">Low BG Color = Light Blue</p> <p style="text-align: right;">High BG Color = Light red</p> <p style="text-align: right;"><b>Monitored Value</b></p> <p>Select and set this option in the <a href="#">Advanced page</a>.</p>

Continued

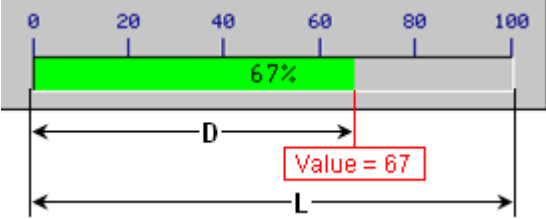
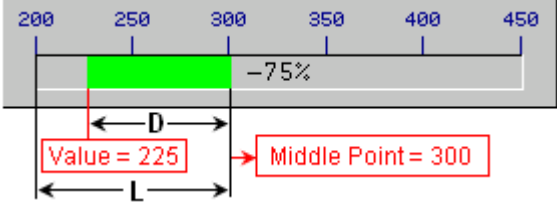
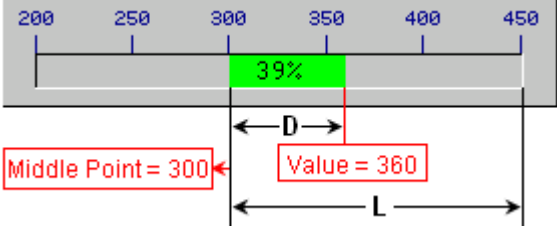
Options	Description		
Percentage Display	A bar graph can show the percentage of the current bar length versus the full bar length.		
	<b>Type</b> Polar Bar		<b>Percentage</b> $D / L \times 100\%$
	Bipolar Bar Value < Middle Point		$- D / L \times 100\%$
	Value > Middle Point		$D / L \times 100\%$
Select and set this option in the <a href="#">Advanced page</a> .			
Visibility Control	A bar graph can be shown or hidden either by a specified bit or by the current user level. Select and set this option in the <a href="#">Visibility page</a> .		

### 8.1.3. Settings

You can complete all the settings of a bar graph in the Bar Graph property sheet. This sheet contains the following four pages.

- **General**  
Described in [Section 8.1.4](#).
- **Scale**  
Described in [Section 4.3.2](#).
- **F. Marker**  
Described in [Section 8.1.5](#).
- **B. Marker**  
Described in [Section 8.1.5](#).
- **Advanced**  
Described in [Section 8.1.6](#).
- **Visibility**  
Described in [Section 4.3.4](#).

### 8.1.4. General Settings

This section describes how to define the general settings for a bar graph.

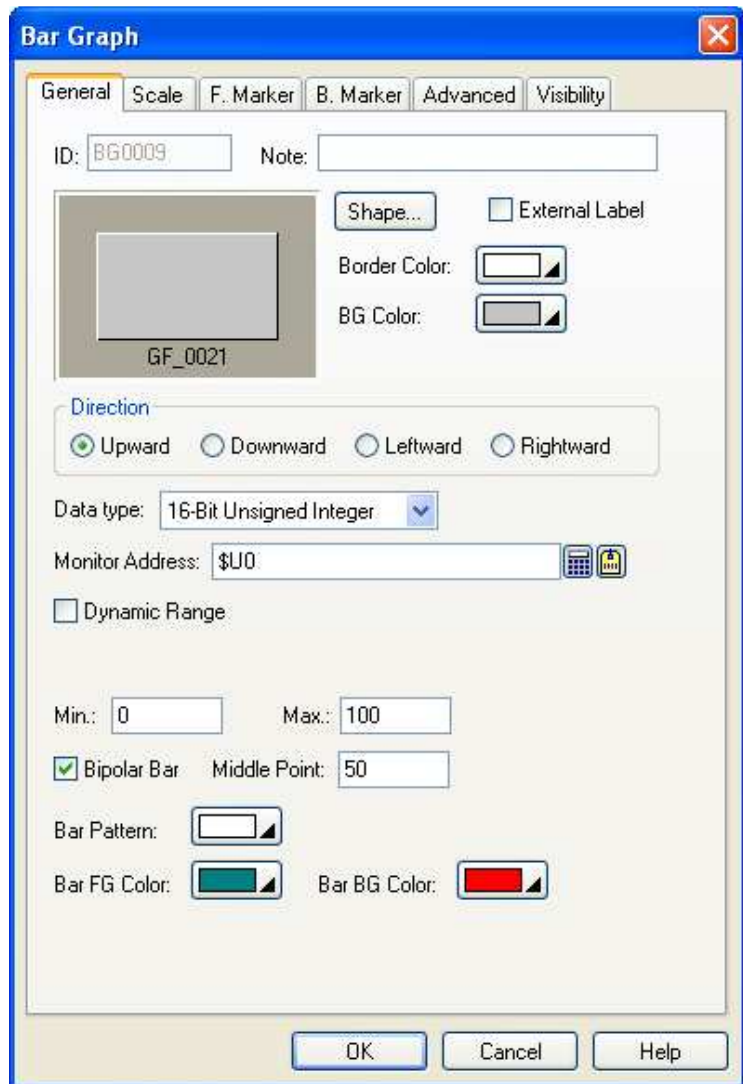
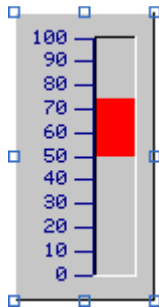

The above is an example of the General page of the Bar Graph dialog box.

The following table describes each property in the General page.

Property	Description
ID	The object's identifier. It is generated when the object is created. The identifier is unique within the screen where the object is on. The format of the ID's for the bar graphs is BGnnnn.
Note	You can type a note for the object.
Shape settings	For details about the following properties, see <a href="#">Section 4.3.1.4 Setting up the Shape of an Object</a> , <a href="#">Shape...</a> , Border Color, BG Color
External Label	Check this option if you want the object to have an external label. Set up the external label in the External Label page.
Direction	Specifies the bar direction for the bar graph.
Data Type	The data type of the monitored variable. The supported data types include: 16-Bit Unsigned Integer, 32-Bit Unsigned Integer, 16-Bit Signed Integer, 32-Bit Signed Integer, 16-Bit BCD, 32-Bit BCD, 32-Bit Floating Point, 16-Bit Signed BCD (LMB), 32-Bit Signed BCD (LMB), 16-Bit Signed BCD (LMD), and 32-Bit Signed BCD (LMD)



Property	Description																																
Monitor Address	Specifies the variable to be monitored. Click  to enter an address for this field. Click  to select a tag for this field.																																
Dynamic Range	Check this option so the minimum and the maximum of the monitored variable will be specified at runtime. When this option is selected, the minimum and maximum of the marks for the scale of the bar graph can be specified at runtime too. The data that specifies the above two ranges should be set and arranged correctly in a memory block called the dynamic range parameter block. You need to specify the dynamic range parameter block for the bar graph in the Dynamic Range Parameter Block field.																																
Dynamic Range Parameter Block	<p>Specifies the variable that stores the dynamic range parameter block for the bar graph when the Dynamic Range is selected. Click  to enter an address for this field. Click  to select a tag for this field.</p> <p>The following table shows the data arrangement of the parameter block when the data type is 16-bit and the scale of the bar graph is not dynamic.</p> <table border="1"> <thead> <tr> <th>Word</th> <th>Parameter</th> </tr> </thead> <tbody> <tr> <td>0</td> <td>The minimum of the monitored variable</td> </tr> <tr> <td>1</td> <td>The maximum of the monitored variable</td> </tr> </tbody> </table> <p>The following table shows the data arrangement of the parameter block when the data type is 16-bit and the scale of the bar graph is dynamic.</p> <table border="1"> <thead> <tr> <th>Word</th> <th>Parameter</th> </tr> </thead> <tbody> <tr> <td>0</td> <td>The minimum of the monitored variable</td> </tr> <tr> <td>1</td> <td>The maximum of the monitored variable</td> </tr> <tr> <td>2, 3</td> <td>The minimum of the mark for the scale; 32-bit integer number</td> </tr> <tr> <td>4, 5</td> <td>The maximum of the mark for the scale; 32-bit integer number</td> </tr> </tbody> </table> <p>The following table shows the data arrangement of the parameter block when the data type is 32-bit and the scale of the bar graph is not dynamic.</p> <table border="1"> <thead> <tr> <th>Word</th> <th>Parameter</th> </tr> </thead> <tbody> <tr> <td>0, 1</td> <td>The minimum of the monitored variable</td> </tr> <tr> <td>2, 3</td> <td>The maximum of the monitored variable</td> </tr> </tbody> </table> <p>The following table shows the data arrangement of the parameter block when the data type is 32-bit and the scale of the bar graph is dynamic.</p> <table border="1"> <thead> <tr> <th>Word</th> <th>Parameter</th> </tr> </thead> <tbody> <tr> <td>0, 1</td> <td>The minimum of the monitored variable</td> </tr> <tr> <td>2, 3</td> <td>The maximum of the monitored variable</td> </tr> <tr> <td>4, 5</td> <td>The minimum of the mark for the scale; 32-bit integer number</td> </tr> <tr> <td>6, 7</td> <td>The maximum of the mark for the scale; 32-bit integer number</td> </tr> </tbody> </table>	Word	Parameter	0	The minimum of the monitored variable	1	The maximum of the monitored variable	Word	Parameter	0	The minimum of the monitored variable	1	The maximum of the monitored variable	2, 3	The minimum of the mark for the scale; 32-bit integer number	4, 5	The maximum of the mark for the scale; 32-bit integer number	Word	Parameter	0, 1	The minimum of the monitored variable	2, 3	The maximum of the monitored variable	Word	Parameter	0, 1	The minimum of the monitored variable	2, 3	The maximum of the monitored variable	4, 5	The minimum of the mark for the scale; 32-bit integer number	6, 7	The maximum of the mark for the scale; 32-bit integer number
Word	Parameter																																
0	The minimum of the monitored variable																																
1	The maximum of the monitored variable																																
Word	Parameter																																
0	The minimum of the monitored variable																																
1	The maximum of the monitored variable																																
2, 3	The minimum of the mark for the scale; 32-bit integer number																																
4, 5	The maximum of the mark for the scale; 32-bit integer number																																
Word	Parameter																																
0, 1	The minimum of the monitored variable																																
2, 3	The maximum of the monitored variable																																
Word	Parameter																																
0, 1	The minimum of the monitored variable																																
2, 3	The maximum of the monitored variable																																
4, 5	The minimum of the mark for the scale; 32-bit integer number																																
6, 7	The maximum of the mark for the scale; 32-bit integer number																																
Min.	Specifies the minimum of the monitored variable when the Dynamic Range is not selected.																																
Max.	Specifies the maximum of the monitored variable when the Dynamic Range is not selected.																																
Bipolar Bar	Check this option so the bar graph will display the difference between the monitored value and the value specified in the Middle Point field.																																
Middle Point	Specifies the reference value/point for the bipolar bar.																																
Pie Pattern	Select a pattern for the bar graph. The pattern will be used to fill the bar. When the pattern is filled in the bar, the black part of the pattern is painted with the color specified in the Bar FG Color field and the white part of the pattern is painted with the color specified in the Bar BG Color field.																																
Pie FG Color	Select a color for painting the black part of the specified pattern.																																
Pie BG Color	Select a color for painting the white part of the specified pattern.																																

### 8.1.5. Forward and Backward Marker Settings

This section describes how to define the forward marker and the backward marker settings for a bar graph. The following is an example of the Forward Marker page.

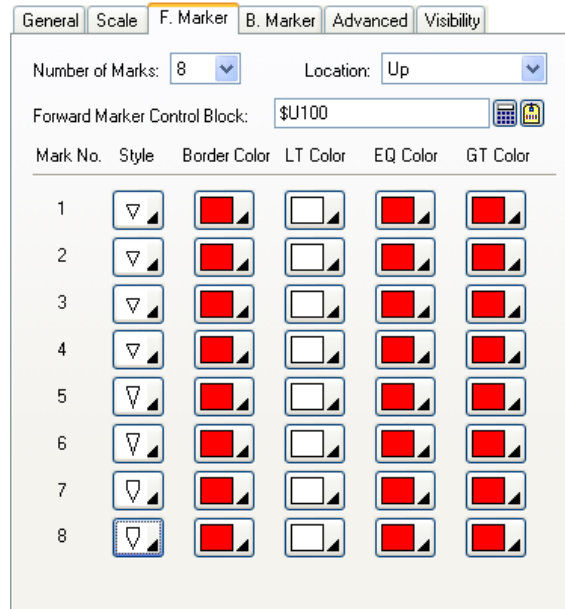

The following table describes each property in the Forward Marker page and the Backward Marker page.

Property	Description																								
Number of Marks	Specifies the maximum number of marks this marker can support.																								
Location	Select Up or Down for the location of the marker when the bar direction is Leftward or Rightward. Select Left or Right for the location of the marker when the bar direction is Upward or Downward.																								
Forward/Backward Marker Control Block	<p>Specifies the variable that stores the marker control block.</p> <p>Click  to enter an address for this field. Click  to select a tag for this field.</p> <p>The following table shows the data arrangement of the marker control block when the data type is 16-bit.</p> <table border="1"> <thead> <tr> <th>Word</th> <th>Description</th> </tr> </thead> <tbody> <tr> <td>0</td> <td>Specifies the actual number of marks that the marker will display.</td> </tr> <tr> <td>1</td> <td>The value of mark 1.</td> </tr> <tr> <td>2</td> <td>The value of mark 2</td> </tr> <tr> <td>...</td> <td>...</td> </tr> <tr> <td>12</td> <td>The value of mark 12</td> </tr> </tbody> </table> <p>The following table shows the data arrangement of the marker control block when the data type is 32-bit.</p> <table border="1"> <thead> <tr> <th>Word</th> <th>Description</th> </tr> </thead> <tbody> <tr> <td>0,1</td> <td>Specifies the actual number of marks that the marker will display.</td> </tr> <tr> <td>2,3</td> <td>The value of mark 1.</td> </tr> <tr> <td>4,5</td> <td>The value of mark 2</td> </tr> <tr> <td>...</td> <td>...</td> </tr> <tr> <td>24,25</td> <td>The value of mark 12</td> </tr> </tbody> </table> <p><b>Note:</b> The data format of the mark values should be the same as that of the monitored variable.</p>	Word	Description	0	Specifies the actual number of marks that the marker will display.	1	The value of mark 1.	2	The value of mark 2	...	...	12	The value of mark 12	Word	Description	0,1	Specifies the actual number of marks that the marker will display.	2,3	The value of mark 1.	4,5	The value of mark 2	...	...	24,25	The value of mark 12
Word	Description																								
0	Specifies the actual number of marks that the marker will display.																								
1	The value of mark 1.																								
2	The value of mark 2																								
...	...																								
12	The value of mark 12																								
Word	Description																								
0,1	Specifies the actual number of marks that the marker will display.																								
2,3	The value of mark 1.																								
4,5	The value of mark 2																								
...	...																								
24,25	The value of mark 12																								

Continued



Property		Description
Mark No. 1 ~ No. 12	Style	Specifies the mark style. There are four mark styles: 
	Border Color	The border color of the mark.
	LT Color	The fill color of the mark when the monitored value is less than the mark's value.
	EQ Color	The fill color of the mark when the monitored value is equal to the mark's value.
	GT Color	The fill color of the mark when the monitored value is greater than the mark's value.



### 8.1.6. Advanced Settings

This section describes how to define the advanced settings for the bar graphs and circular bar graphs with the Advanced page. The following is an example of the Advanced page.

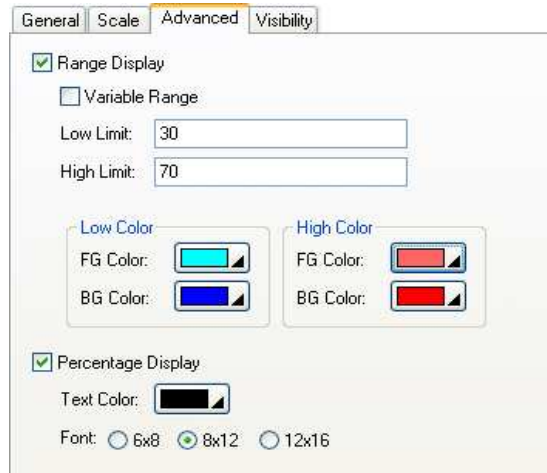











The following table describes each property in the Advanced page.

Property		Description	
Range Display	Range Display	Check this option if you want the object to display the monitored value with different color when the monitored value is below the specified low limit or over the specified high limit.	
	Variable Range	Check this option if the low limit and high limit are specified at runtime by the designated variables.	
	Low Limit	Specifies the low limit when the Variable Range is not selected. When the Variable Range is selected, this property specifies the variable whose value is the low limit. Click  to enter an address. Click  to select a tag.	
	High Limit	Specifies the high limit when the Variable Range is not selected. When the Variable Range is selected, this property specifies the variable whose value is the high limit. Click  to enter an address. Click  to select a tag.	
	High Color	FG Color	The bar FG color for the high limit.
		BG Color	The bar BG color for the high limit.
	Low Color	FG Color	The bar FG color for the low limit.
BG Color		The bar BG color for the low limit.	
Percentage Display	Percentage Display	Check this option so the object will display the percentage that is calculated by the following formula: $\text{Percentage} = (\text{Value} - \text{Min.}) / (\text{Max.} - \text{Min.}) * 100\%$ <p>If the bipolar bar is used, the percentage formula when Value &gt; Middle Point is:  <math display="block">\text{Percentage} = (\text{Value} - \text{Middle Point}) / (\text{Max.} - \text{Middle Point}) * 100\%</math>                     the percentage formula when Value &lt; Middle Point is:  <math display="block">\text{Percentage} = -(\text{Middle Point} - \text{Value}) / (\text{Middle Point} - \text{Min.}) * 100\%</math>                     The <i>Value</i> is the current value of the monitored variable. The <i>Max.</i> and <i>Min.</i> defines the value range of the monitored variable and are defined in the General page of the property sheet.</p>	
	Text Color	Select a color for the percentage display.	
	Font	Select a fixed size font for the percentage display.	

## 8.2. Meters

### 8.2.1. Basic Operations

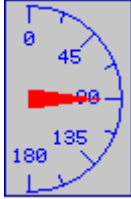
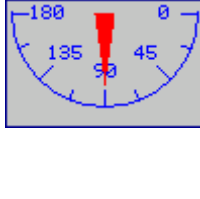
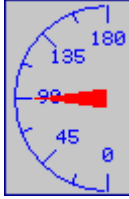
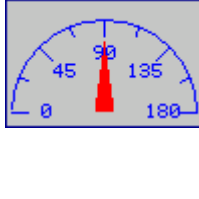
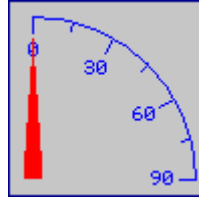
A meter shows the value of a monitored variable by rotating its needle to the appropriate place. When the value of the variable increases or decreases the rotation angle of the needle increases or decreases accordingly. A meter can have an arc/circle scale and the scale enables you to measure the rotation angle of the needle and read the current value for the monitored variable. A meter can be configured to perform one of the following swing types:

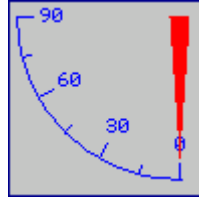
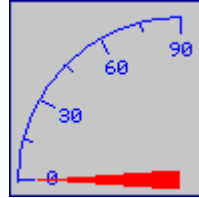
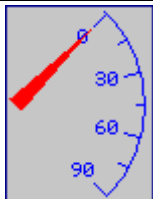
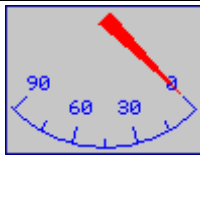
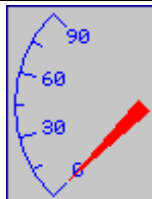
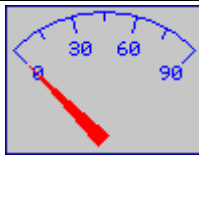
<b>Span and Origin</b>	360° & 90°	360° & 0°	360° & 270°	360° & 180°
<b>Example</b>				
<b>Span and Origin</b>	270° & 45°	270° & 315°	270° & 225°	270° & 135°
<b>Example</b>				
<b>Span and Origin</b>	180° & 90°	180° & 0°	180° & 270°	180° & 180°
<b>Example</b>				
<b>Span and Origin</b>	90° & 90°	90° & 0°	90° & 270°	90° & 180°
<b>Example</b>				
<b>Span and Origin</b>	90° & 45°	90° & 315°	90° & 225°	90° & 135°
<b>Example</b>				

## 8.2.2. Operation Options

The following operation options can be added to a meter to make it more informative. You need to select and set these options in the Meter property sheet.

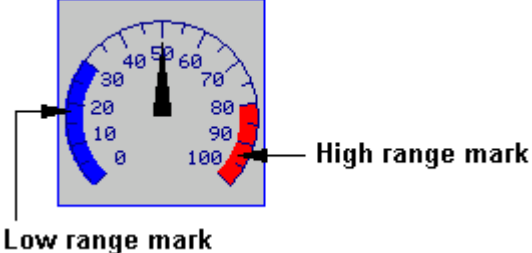
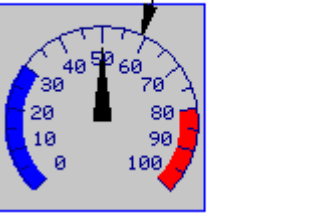
Options	Description
Range Display	 <p>The meter can display the low range mark and the high range mark along its swing path.. The limits for range marks can be specified at runtime by the designated variables. Select and set this option in the Range page.</p>
Scale	 <p>The meter can have a scale. Select and set this option in the Scale page.</p>
Visibility Control	<p>The meter can be shown or hidden either by a specified bit or by the current user level. Select and set this option in the Visibility page.</p>

## 8.2.3. Settings

You can complete all the settings of a meter in the Meter property sheet. This sheet contains the following four pages.

- **General**  
Described in [Section 8.2.4.](#)
- **Range**  
Described in [Section 8.2.5.](#)
- **Scale**  
Described in [Section 4.3.2.](#)
- **Visibility**  
Described in [Section 4.3.4.](#)



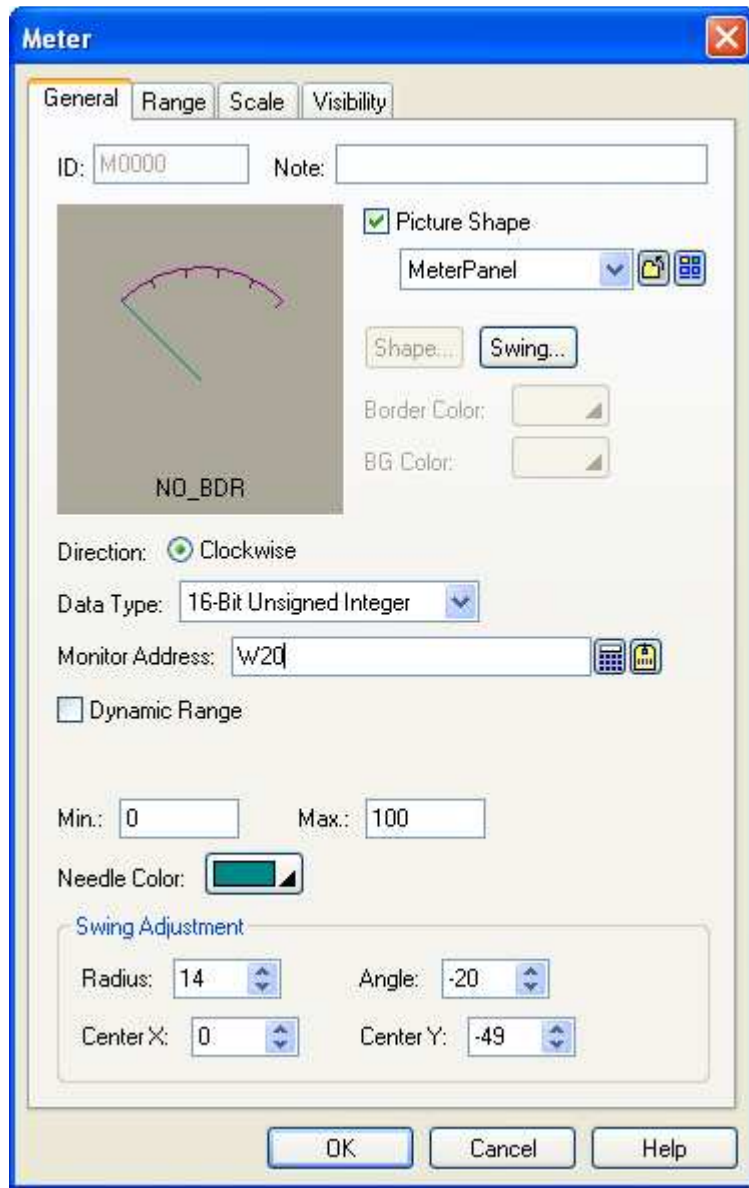
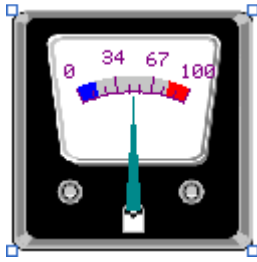

### 8.2.4. General Settings

This section describes how to define the general settings for a meter.



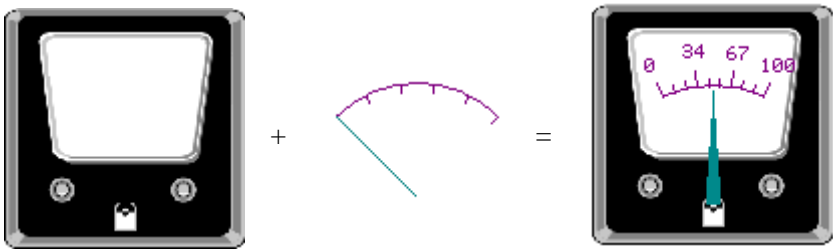

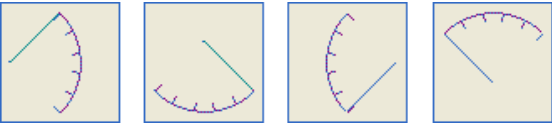
The above is an example of the General page of the Meter property sheet.

The following table describes each property in the General page.

Property		Description
ID		The object's identifier. It is generated when the object is created. The identifier is unique within the screen where the object is on. The format of the ID's for the meters is Mnnnn.
Note		You can type a note for the object.
Picture Shape	Picture Shape	Check this option if you want to use a picture for the meter's shape. You can use a picture to customize your own meter. For example:   <b>Note:</b> If the Picture Shape is checked, Shape..., Border Color and BG Color field are not available to be used.
	<Drop-down List>	The name of the picture. You can use the drop-down list to select a picture from the picture database.
		Click this icon to select a picture file. After the selection, the picture of the selected file is imported and saved in the picture database.
		Click this icon to bring up the Select/Import from Library dialog box. Select a picture from a picture library file. After the selection, the selected picture is imported and saved in the picture database.
Graphical shape settings		For details about the following properties, <a href="#">Section 4.3.1.4 Setting up the Shape of an Object</a> . <input type="text" value="Shape..."/> , Border Color, BG Color
Swing		Specifies the types of swing. For details, see <a href="#">Section 8.2.1 Basic Operation</a> . The swing styles on the left are more spacing saving because their needle can be located outside the shape by changing the position of Center X or Center Y. 
Direction		Specifies the direction that the needle moves. Now only the Clockwise is available.
Data Type		The data type of the monitored variable. The supported data types include: 16-Bit Unsigned Integer, 32-Bit Unsigned Integer, 16-Bit Signed Integer, 32-Bit Signed Integer, 16-Bit BCD, 32-Bit BCD, 32-Bit Floating Point, 16-Bit Signed BCD (LMB), 32-Bit Signed BCD (LMB), 16-Bit Signed BCD (LMD), and 32-Bit Signed BCD (LMD).
Monitor Address		Specifies the variable to be monitored. Click  to enter an address for this field. Click  to select a tag for this field.

Continued









Property		Description																															
Dynamic Range	Dynamic Range	Check this option so the minimum and the maximum of the monitored variable will be specified at runtime. When this option is selected, the minimum and maximum of the marks for the scale of the meter can be specified at runtime too. The data that specifies the above two ranges should be set and arranged correctly in a memory block called the dynamic range parameter block. You need to specify the dynamic range parameter block for the meter in the Dynamic Range Parameter Block field.																															
	Dynamic Range Parameter Block	<p>Specifies the variable that stores the dynamic range parameter block for the meter when the Dynamic Range is selected. Click  to enter an address for this field. Click  to select a tag for this field. The following table shows the content of the parameter block when the data type is 16-bit and the scale of the meter is not dynamic.</p> <table border="1"> <thead> <tr> <th>Word</th> <th>Parameter</th> </tr> </thead> <tbody> <tr> <td>0</td> <td>The minimum of the monitored variable</td> </tr> <tr> <td>1</td> <td>The maximum of the monitored variable</td> </tr> </tbody> </table> <p>The following table shows the content of the parameter block when the data type is 16-bit and the scale of the meter is dynamic.</p> <table border="1"> <thead> <tr> <th>Word</th> <th>Parameter</th> </tr> </thead> <tbody> <tr> <td>0</td> <td>The minimum of the monitored variable</td> </tr> <tr> <td>1</td> <td>The maximum of the monitored variable</td> </tr> <tr> <td>2, 3</td> <td>The minimum of the mark for the scale; 32-bit integer number</td> </tr> <tr> <td>4, 5</td> <td>The maximum of the mark for the scale; 32-bit integer number</td> </tr> </tbody> </table> <p>The following table shows the content of the parameter block when the data type is 32-bit and the scale of the meter is not dynamic.</p> <table border="1"> <thead> <tr> <th>Word</th> <th>Parameter</th> </tr> </thead> <tbody> <tr> <td>0, 1</td> <td>The minimum of the monitored variable</td> </tr> <tr> <td>2, 3</td> <td>The maximum of the monitored variable</td> </tr> </tbody> </table> <p>The following table shows the content of the parameter block when the data type is 32-bit and the scale of the meter is dynamic.</p> <table border="1"> <thead> <tr> <th>Word</th> <th>Parameter</th> </tr> </thead> <tbody> <tr> <td>0, 1</td> <td>The minimum of the monitored variable</td> </tr> <tr> <td>2, 3</td> <td>The maximum of the monitored variable</td> </tr> <tr> <td>4, 5</td> <td>The minimum of the mark for the scale; 32-bit integer number</td> </tr> <tr> <td>6, 7</td> <td>The maximum of the mark for the scale; 32-bit integer number</td> </tr> </tbody> </table>	Word	Parameter	0	The minimum of the monitored variable	1	The maximum of the monitored variable	Word	Parameter	0	The minimum of the monitored variable	1	The maximum of the monitored variable	2, 3	The minimum of the mark for the scale; 32-bit integer number	4, 5	The maximum of the mark for the scale; 32-bit integer number	Word	Parameter	0, 1	The minimum of the monitored variable	2, 3	The maximum of the monitored variable	Word	Parameter	0, 1	The minimum of the monitored variable	2, 3	The maximum of the monitored variable	4, 5	The minimum of the mark for the scale; 32-bit integer number	6, 7
Word	Parameter																																
0	The minimum of the monitored variable																																
1	The maximum of the monitored variable																																
Word	Parameter																																
0	The minimum of the monitored variable																																
1	The maximum of the monitored variable																																
2, 3	The minimum of the mark for the scale; 32-bit integer number																																
4, 5	The maximum of the mark for the scale; 32-bit integer number																																
Word	Parameter																																
0, 1	The minimum of the monitored variable																																
2, 3	The maximum of the monitored variable																																
Word	Parameter																																
0, 1	The minimum of the monitored variable																																
2, 3	The maximum of the monitored variable																																
4, 5	The minimum of the mark for the scale; 32-bit integer number																																
6, 7	The maximum of the mark for the scale; 32-bit integer number																																
Min.		Specifies the minimum of the monitored variable when the Dynamic Range is not selected.																															
Max.		Specifies the maximum of the monitored variable when the Dynamic Range is not selected.																															
Needle Color		Select a color for the needle.																															
Swing Adjustment	Radius	You can adjust the radius for the swing of the needle. This field specifies the offset to be added to the default radius.																															
	Angle	You can adjust the span for the swing of the needle. This field specifies the offset to be added to the default span.																															
	Center X	You can adjust the horizontal position for the pivot of the needle. This field specifies the offset to be added to the default horizontal position.																															
	Center Y	You can adjust the vertical position for the pivot of the needle. This field specifies the offset to be added to the default vertical position.																															





## 8.2.5. Range Settings

This section describes how to define the range settings for a meter. The following is an example of the Range page of the Meter property sheet.

The screenshot shows the 'Range' tab of a property sheet. It contains the following elements:

- Range Display
- Variable Range
- Low Limit:   
- High Limit:   
- Low Color: 
- High Color: 

The following table describes each property in the Range page.

Property	Description
Range Display	Check this option if you want the meter to display the range marks along its swing path.
Variable Range	Check this option so the low limit and high limit for the range marks will be specified at runtime by the designated variables.
Low Limit	Specifies the low limit for the low range mark when the Variable Range is not selected. When the Variable Range is selected, this property specifies the variable whose value is the low limit for the low range mark at runtime. Click  to enter an address for this field. Click  to select a tag for this field.
High Limit	Specifies the high limit for the high range mark when the Variable Range is not selected. When the Variable Range is selected, this property specifies the variable whose value is the high limit for the high range mark at runtime. Click  to enter an address for this field. Click  to select a tag for this field.
Low Color	The color of the low range mark.
High Color	The color of the high range mark.

### 8.3. Circular Bar Graphs

#### 8.3.1. Basic Operations

A circular bar graph shows the value of a monitored variable by displaying a circular bar with variable length. When the value of the variable increases or decreases, the length of the circular bar increases or decreases accordingly. A circular bar graph can have a circular scale and the scale enables you to measure the length of the bar and read the current value for the monitored variable. The following table lists the supported styles for the circular bar graphs.

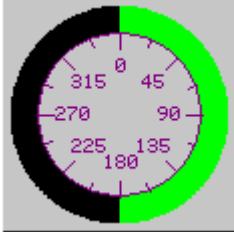
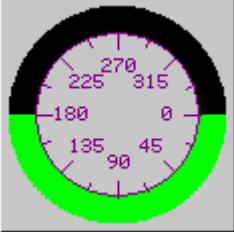
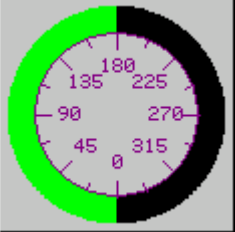
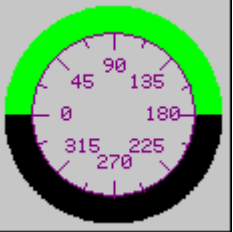
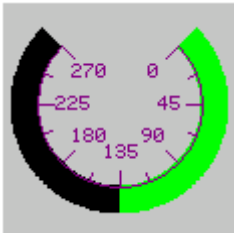
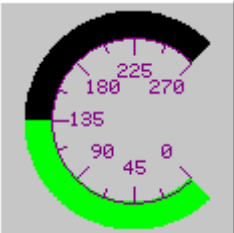
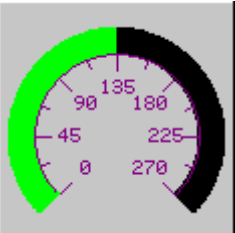
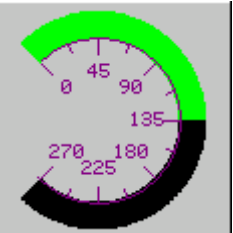
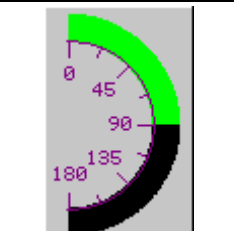
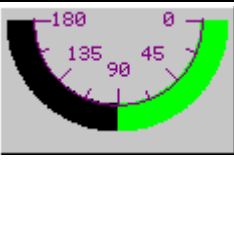
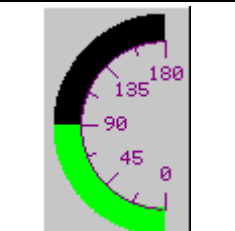
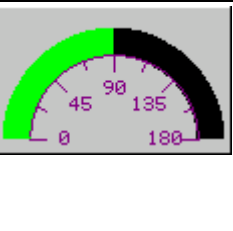
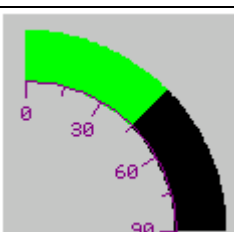
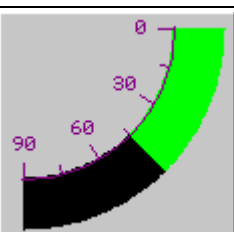
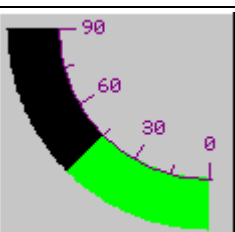
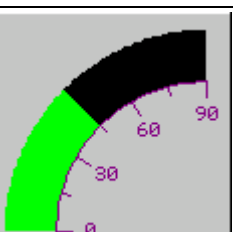
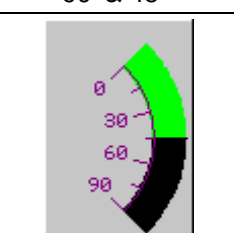
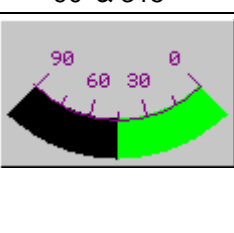
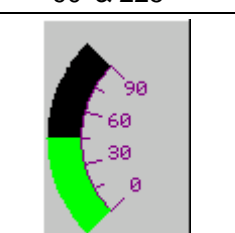
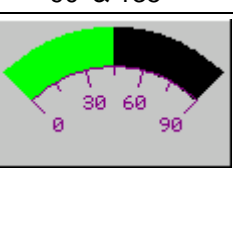
<b>Span and Origin</b>	360° & 90°	360° & 0°	360° & 270°	360° & 180°
<b>Example</b>				
<b>Span and Origin</b>	270° & 45°	270° & 315°	270° & 225°	270° & 135°
<b>Example</b>				
<b>Span and Origin</b>	180° & 90°	180° & 0°	180° & 270°	180° & 180°
<b>Example</b>				
<b>Span and Origin</b>	90° & 90°	90° & 0°	90° & 270°	90° & 180°
<b>Example</b>				
<b>Span and Origin</b>	90° & 45°	90° & 315°	90° & 225°	90° & 135°
<b>Example</b>				



### 8.3.2. Operation Options

The following operation options can be added to a circular bar graph to make it more informative. You need to select and set up these options in the Circular Bar Graph property sheet.

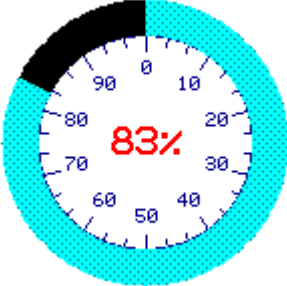
Options	Description
Range Display	You can specify a low limit and a high limit for the object. The limits can be constants or variables. At runtime, when the monitored value is below the low limit, the object shows the bar with the FG color and the BG color set for the low limit. When the monitored value is over the high limit, the object shows the bar with the FG color and the BG color set for the high limit.
Percentage Display	<p>The object can show the percentage of the current bar length versus the full bar length.</p>  <p>Select and set up this option in the Advanced page.</p>
Scale	The circular bar graph can have a circular scale. Select and set up this option in the Scale page.
Visibility Control	The object can be shown or hidden either by a specified bit or by the current user level. Select and set up this option in the Visibility page.

### 8.3.3. Settings

You can complete all the settings of a circular bar graph in the Circular Bar Graph property sheet. This sheet contains the following four pages.

- **General**  
Described in [Section 8.3.4.](#)
- **Scale**  
Described in [Section 4.3.2.](#)
- **Advanced**  
Described in [Section 4.3.3.](#)
- **Visibility**  
Described in [Section 4.3.4.](#)

### 8.3.4. General Settings

This section describes how to define the general settings for a circular bar graph.

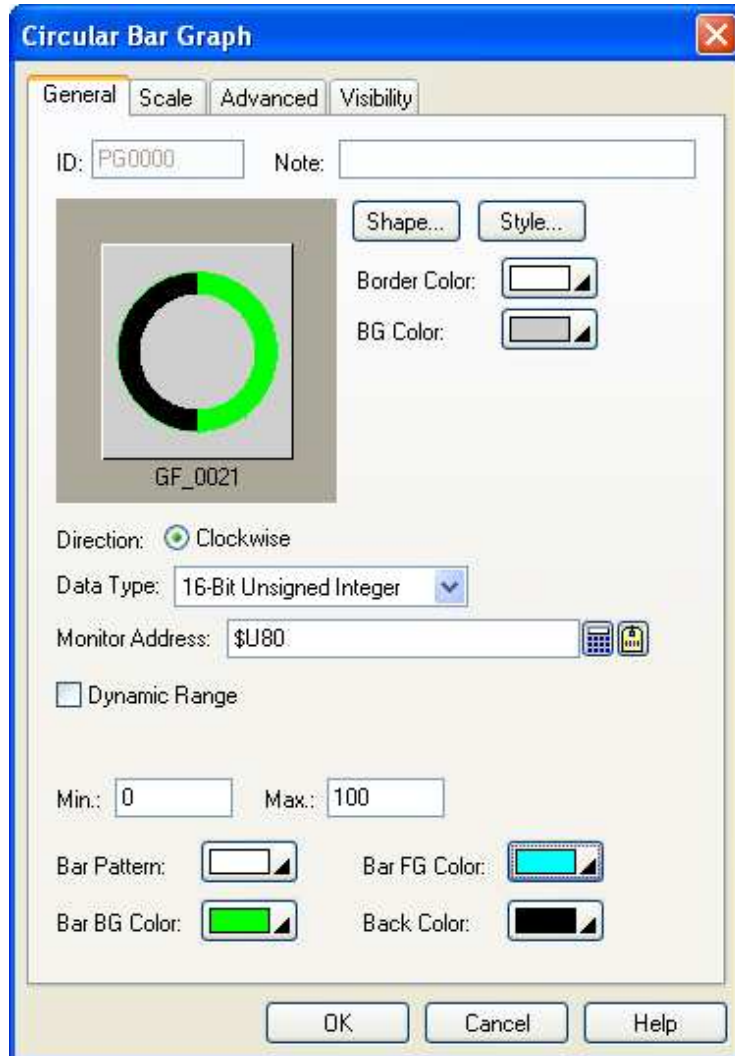

The above is an example of the General page of the Circular Bar Graph property sheet.

The following table describes each property in the General page.

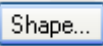
Property	Description
ID	The object's identifier. It is generated when the object is created. The identifier is unique within the screen where the object is on. The format of the ID's for the circular bar graphs is PGnnnn.
Note	You can type a note for the object.
Shape settings	For details about the following properties, <a href="#">Section 4.3.1.4 Setting up the Shape of an Object</a> .  , Border Color, BG Color
Style	Specifies the style of the circular bar graph. For details, see <a href="#">Section 8.3.1 Basic Operations</a> .
Direction	Specifies the progress direction of the circular bar graph. Now only the Clockwise is available.
Data Type	The data type of the monitored variable. The supported data types include: 16-Bit Unsigned Integer, 32-Bit Unsigned Integer, 16-Bit Signed Integer, 32-Bit Signed Integer, 16-Bit BCD, 32-Bit BCD, and 32-Bit Floating Point.

Continued



Property	Description																																
Monitor Address	Specifies the variable to be monitored. Click  to enter an address for this field. Click  to select a tag for this field.																																
Dynamic Range	Check this option so the minimum and the maximum of the monitored variable will be specified at runtime. When this option is selected, the minimum and maximum of the marks for the scale of the circular bar graph can be specified at runtime too. The data that specifies the above two ranges should be set and arranged correctly in a memory block called the dynamic range parameter block. You need to specify the dynamic range parameter block for the circular bar graph in the Dynamic Range Parameter Block field.																																
Dynamic Range Parameter Block	Specifies the variable that stores the dynamic range parameter block for the circular bar graph when the Dynamic Range is selected. Click  to enter an address for this field. Click  to select a tag for this field. The following table shows the content of the parameter block when the data type is 16-bit and the scale of the circular bar graph is not dynamic. <table border="1" style="margin-left: 20px;"> <thead> <tr> <th>Word</th> <th>Parameter</th> </tr> </thead> <tbody> <tr> <td>0</td> <td>The minimum of the monitored variable</td> </tr> <tr> <td>1</td> <td>The maximum of the monitored variable</td> </tr> </tbody> </table> The following table shows the content of the parameter block when the data type is 16-bit and the scale of the circular bar graph is dynamic. <table border="1" style="margin-left: 20px;"> <thead> <tr> <th>Word</th> <th>Parameter</th> </tr> </thead> <tbody> <tr> <td>0</td> <td>The minimum of the monitored variable</td> </tr> <tr> <td>1</td> <td>The maximum of the monitored variable</td> </tr> <tr> <td>2, 3</td> <td>The minimum of the mark for the scale; 32-bit integer number</td> </tr> <tr> <td>4, 5</td> <td>The maximum of the mark for the scale; 32-bit integer number</td> </tr> </tbody> </table> The following table shows the content of the parameter block when the data type is 32-bit and the scale of the circular bar graph is not dynamic. <table border="1" style="margin-left: 20px;"> <thead> <tr> <th>Word</th> <th>Parameter</th> </tr> </thead> <tbody> <tr> <td>0, 1</td> <td>The minimum of the monitored variable</td> </tr> <tr> <td>2, 3</td> <td>The maximum of the monitored variable</td> </tr> </tbody> </table> The following table shows the content of the parameter block when the data type is 32-bit and the scale of the circular bar graph is dynamic. <table border="1" style="margin-left: 20px;"> <thead> <tr> <th>Word</th> <th>Parameter</th> </tr> </thead> <tbody> <tr> <td>0, 1</td> <td>The minimum of the monitored variable</td> </tr> <tr> <td>2, 3</td> <td>The maximum of the monitored variable</td> </tr> <tr> <td>4, 5</td> <td>The minimum of the mark for the scale; 32-bit integer number</td> </tr> <tr> <td>6, 7</td> <td>The maximum of the mark for the scale; 32-bit integer number</td> </tr> </tbody> </table>	Word	Parameter	0	The minimum of the monitored variable	1	The maximum of the monitored variable	Word	Parameter	0	The minimum of the monitored variable	1	The maximum of the monitored variable	2, 3	The minimum of the mark for the scale; 32-bit integer number	4, 5	The maximum of the mark for the scale; 32-bit integer number	Word	Parameter	0, 1	The minimum of the monitored variable	2, 3	The maximum of the monitored variable	Word	Parameter	0, 1	The minimum of the monitored variable	2, 3	The maximum of the monitored variable	4, 5	The minimum of the mark for the scale; 32-bit integer number	6, 7	The maximum of the mark for the scale; 32-bit integer number
Word	Parameter																																
0	The minimum of the monitored variable																																
1	The maximum of the monitored variable																																
Word	Parameter																																
0	The minimum of the monitored variable																																
1	The maximum of the monitored variable																																
2, 3	The minimum of the mark for the scale; 32-bit integer number																																
4, 5	The maximum of the mark for the scale; 32-bit integer number																																
Word	Parameter																																
0, 1	The minimum of the monitored variable																																
2, 3	The maximum of the monitored variable																																
Word	Parameter																																
0, 1	The minimum of the monitored variable																																
2, 3	The maximum of the monitored variable																																
4, 5	The minimum of the mark for the scale; 32-bit integer number																																
6, 7	The maximum of the mark for the scale; 32-bit integer number																																
Min.	Specifies the minimum of the monitored variable when the Dynamic Range is not selected.																																
Max.	Specifies the maximum of the monitored variable when the Dynamic Range is not selected.																																
Bar Pattern	Select a pattern for the circular bar graph. The pattern will be used to fill the arc/circular strip of the circular bar graph. When the pattern is filled in the circular bar graph, the black part of the pattern is painted with the color specified in the Bar FG Color field and the white part of the pattern is painted with the color specified in the Bar BG Color field.																																
Bar FG Color	Select a color for painting the black part of the specified pattern.																																
Bar BG Color	Select a color for painting the white part of the specified pattern.																																
Back Color	Select a color as the background color for the arc/circular strip of the circular bar graph.																																

## 8.4. Line Charts

### 8.4.1. Basic Operations

A line chart displays a set of data by drawing a data point for each datum and drawing a line that connects all the data points in sequence. The vertical position of a data point is determined by the value of the associated datum. The horizontal position of a data point is determined by the order of the associated datum in the data set.

Number of data points	5
Data point 0	40
Data point 1	60
Data point 2	50
Data point 3	35
Data point 4	70

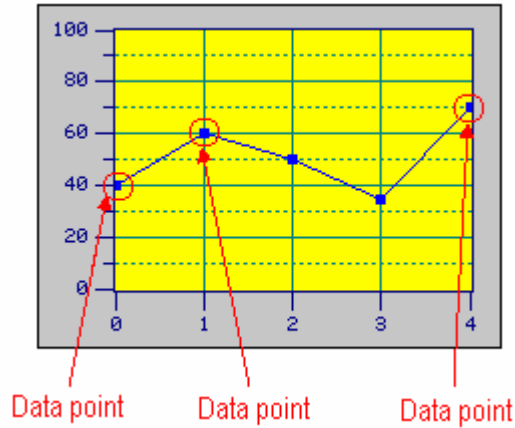

A line chart can display up to 8 sets of data. The following example shows a line chart that displays 3 sets of data.

Number of data points	5		
Data set	1	2	3
Data point 0	40	20	70
Data point 1	60	25	80
Data point 2	50	40	60
Data point 3	35	60	70
Data point 4	70	90	80

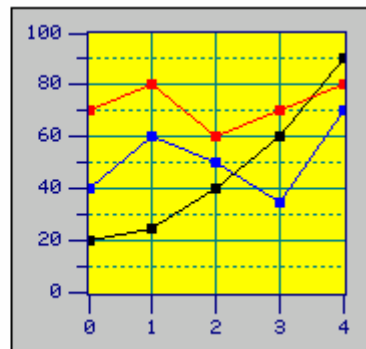

A line chart can provide a cursor for you to select desired data points. The cursor of the line chart is a vertical line segment. The user can move the cursor horizontally within a line chart to the desired data point(s). The values of the selected data points can be displayed and output to an internal variable called Cursor Data Receiving Buffer.

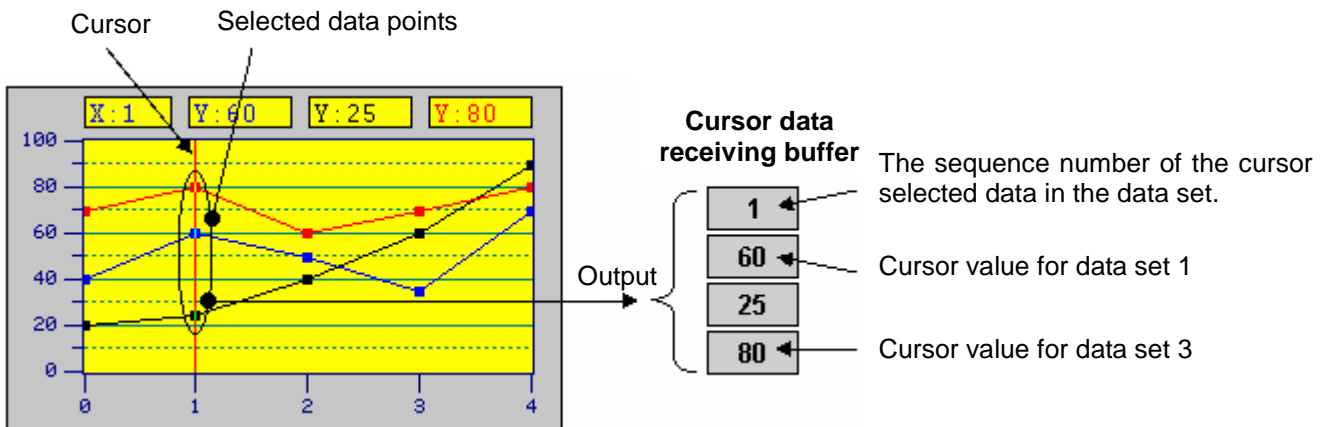



## 8.4.2. Operation Options

The following operation option can be added to a line chart. Select and set the option in the Line Chart dialog box.

Options	Description
Visibility Control	You can show and hide a line chart by a specified bit or the current user level. Select and set this option in the Visibility page.

## 8.4.3. Settings

You can complete all the settings of a line chart in the Line Chart dialog box. This dialog box contains the following four pages.

- **General**

Described in [Section 8.4.4.](#)

- **Pen**

Described in [Section 8.4.5.](#)

- **XY Axis**

Described in [Section 8.4.6.](#)

- **Visibility**

Described in [Section 4.3.4.](#)



### 8.4.4. General Settings

This section describes how to define the general settings for a line chart. The following is an example of the General page of the Line Chart property sheet.

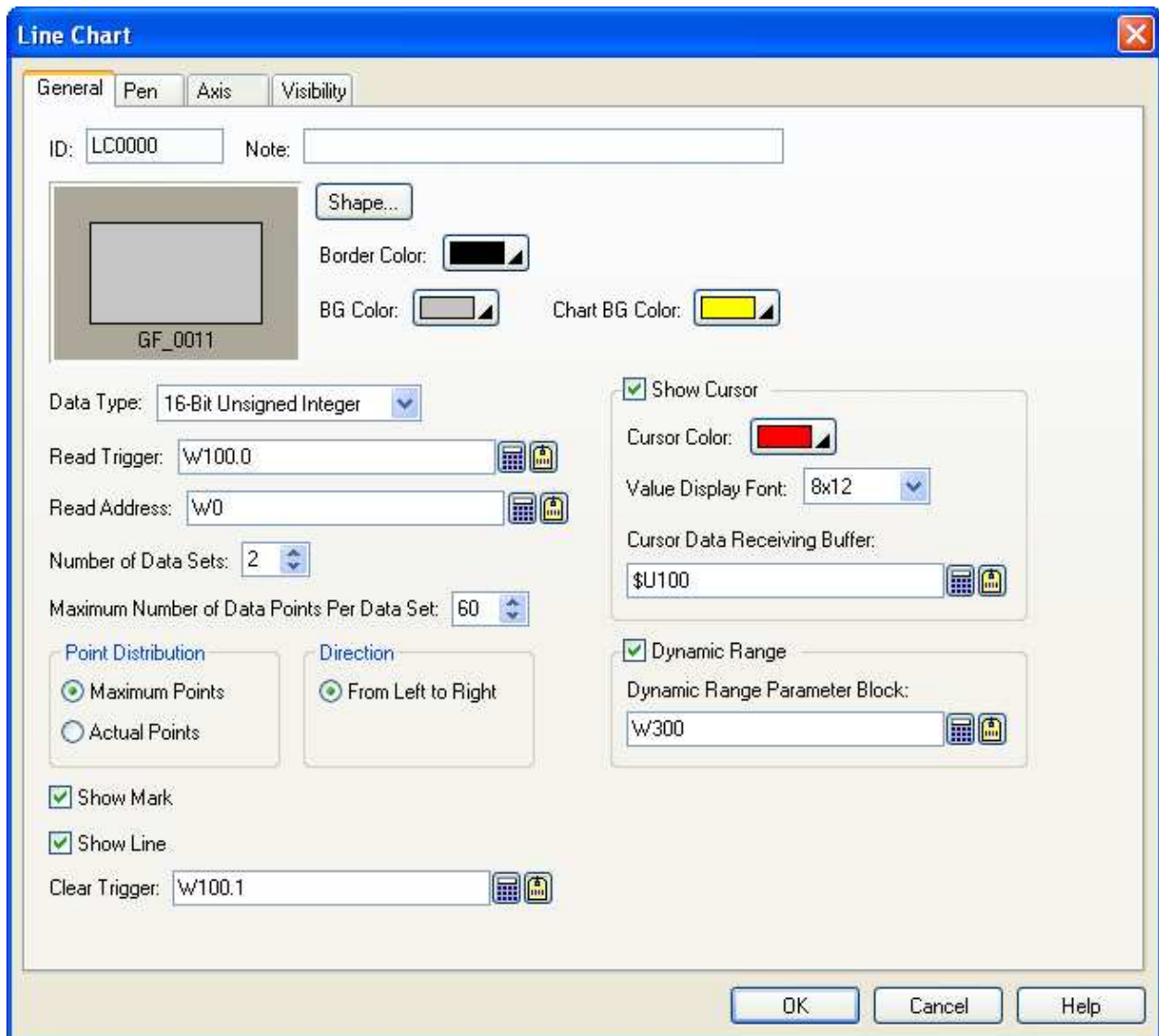



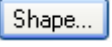

The following table describes each property in the General page.

Property	Description
ID	The object's identifier. It is generated when the object is created. The identifier is unique within the screen where the object is on. The format of the ID's for the line charts is LCnnnn.
Note	You can type a note for the object.
Shape settings	For details about the following properties, see <a href="#">Section 4.3.1.4 Setting up the Shape of an Object</a> .  , Border Color, BG Color
Chart BG Color	Select a color for the background of the chart.
Data Type	The type of the data that the line chart will display. The supported data types include: 16-Bit Unsigned Integer, 32-Bit Unsigned Integer, 16-Bit Signed Integer, 32-Bit Signed Integer, 16-Bit BCD, 32-Bit BCD, 32-Bit Floating Point, 16-Bit Signed BCD (LMB), 32-Bit Signed BCD (LMB), 16-Bit Signed BCD (LMD), and 32-Bit Signed BCD (LMD).

Continued



Property	Description																																																												
Read Trigger	The bit variable that will trigger the line chart to read and display data. The bit variable triggers the line chart when its state changes from off to on. Click  to enter an address for this field. Click  to select a tag for this field.																																																												
Read Address	<p>The variable whose data is to be read and displayed. Click  to enter an address for this field. Click  to select a tag for this field.</p> <p>The following tables show the data arrangements of the variable.</p> <p><b>Data Type: 16-bit; Number of Data Sets: 1</b></p> <table border="1" data-bbox="395 577 919 835"> <thead> <tr> <th>Word</th> <th>Description</th> </tr> </thead> <tbody> <tr> <td>0</td> <td>Actual number of data points</td> </tr> <tr> <td>1</td> <td>Data point 0</td> </tr> <tr> <td>2</td> <td>Data point 1</td> </tr> <tr> <td>...</td> <td>...</td> </tr> <tr> <td>n+1</td> <td>Data point n</td> </tr> </tbody> </table> <p><b>Data Type: 16-bit; Number of Data Sets: 2</b></p> <table border="1" data-bbox="395 913 919 1294"> <thead> <tr> <th>Word</th> <th>Description</th> </tr> </thead> <tbody> <tr> <td>0</td> <td>Actual number of data points</td> </tr> <tr> <td>1</td> <td>Data point 0; Data set 1</td> </tr> <tr> <td>2</td> <td>Data point 0; Data set 2</td> </tr> <tr> <td>3</td> <td>Data point 1; Data set 1</td> </tr> <tr> <td>4</td> <td>Data point 1; Data set 2</td> </tr> <tr> <td>...</td> <td>...</td> </tr> <tr> <td>2n+1</td> <td>Data point n; Data set 1</td> </tr> <tr> <td>2n+2</td> <td>Data point n; Data set 2</td> </tr> </tbody> </table> <p><b>Data Type: 16-bit; Number of Data Sets: 8</b></p> <table border="1" data-bbox="395 1373 919 2011"> <thead> <tr> <th>Word</th> <th>Description</th> </tr> </thead> <tbody> <tr> <td>0</td> <td>Actual number of data points</td> </tr> <tr> <td>1</td> <td>Data point 0; Data set 1</td> </tr> <tr> <td>2</td> <td>Data point 0; Data set 2</td> </tr> <tr> <td>3</td> <td>Data point 0; Data set 3</td> </tr> <tr> <td>4</td> <td>Data point 0; Data set 4</td> </tr> <tr> <td>5</td> <td>Data point 0; Data set 5</td> </tr> <tr> <td>6</td> <td>Data point 0; Data set 6</td> </tr> <tr> <td>7</td> <td>Data point 0; Data set 7</td> </tr> <tr> <td>8</td> <td>Data point 0; Data set 8</td> </tr> <tr> <td>9</td> <td>Data point 1; Data set 1</td> </tr> <tr> <td>10</td> <td>Data point 1; Data set 2</td> </tr> <tr> <td>...</td> <td>...</td> </tr> <tr> <td>8n+7</td> <td>Data point n; Data set 7</td> </tr> <tr> <td>8n+8</td> <td>Data point n; Data set 8</td> </tr> </tbody> </table>	Word	Description	0	Actual number of data points	1	Data point 0	2	Data point 1	...	...	n+1	Data point n	Word	Description	0	Actual number of data points	1	Data point 0; Data set 1	2	Data point 0; Data set 2	3	Data point 1; Data set 1	4	Data point 1; Data set 2	...	...	2n+1	Data point n; Data set 1	2n+2	Data point n; Data set 2	Word	Description	0	Actual number of data points	1	Data point 0; Data set 1	2	Data point 0; Data set 2	3	Data point 0; Data set 3	4	Data point 0; Data set 4	5	Data point 0; Data set 5	6	Data point 0; Data set 6	7	Data point 0; Data set 7	8	Data point 0; Data set 8	9	Data point 1; Data set 1	10	Data point 1; Data set 2	...	...	8n+7	Data point n; Data set 7	8n+8	Data point n; Data set 8
Word	Description																																																												
0	Actual number of data points																																																												
1	Data point 0																																																												
2	Data point 1																																																												
...	...																																																												
n+1	Data point n																																																												
Word	Description																																																												
0	Actual number of data points																																																												
1	Data point 0; Data set 1																																																												
2	Data point 0; Data set 2																																																												
3	Data point 1; Data set 1																																																												
4	Data point 1; Data set 2																																																												
...	...																																																												
2n+1	Data point n; Data set 1																																																												
2n+2	Data point n; Data set 2																																																												
Word	Description																																																												
0	Actual number of data points																																																												
1	Data point 0; Data set 1																																																												
2	Data point 0; Data set 2																																																												
3	Data point 0; Data set 3																																																												
4	Data point 0; Data set 4																																																												
5	Data point 0; Data set 5																																																												
6	Data point 0; Data set 6																																																												
7	Data point 0; Data set 7																																																												
8	Data point 0; Data set 8																																																												
9	Data point 1; Data set 1																																																												
10	Data point 1; Data set 2																																																												
...	...																																																												
8n+7	Data point n; Data set 7																																																												
8n+8	Data point n; Data set 8																																																												

Continued



Property	Description																														
Read Address	<p><b>Data Type: 32-bit; Number of Data Sets: 1</b></p> <table border="1"> <thead> <tr> <th>Word</th> <th>Description</th> </tr> </thead> <tbody> <tr> <td>0,1</td> <td>Actual number of data points</td> </tr> <tr> <td>2,3</td> <td>Data point 0</td> </tr> <tr> <td>4,5</td> <td>Data point 1</td> </tr> <tr> <td>...</td> <td>...</td> </tr> <tr> <td>2n+2, 2n+3</td> <td>Data point n</td> </tr> </tbody> </table>	Word	Description	0,1	Actual number of data points	2,3	Data point 0	4,5	Data point 1	...	...	2n+2, 2n+3	Data point n																		
	Word	Description																													
	0,1	Actual number of data points																													
2,3	Data point 0																														
4,5	Data point 1																														
...	...																														
2n+2, 2n+3	Data point n																														
Read Address	<p><b>Data Type: 32-bit; Number of Data Sets: 2</b></p> <table border="1"> <thead> <tr> <th>Word</th> <th>Description</th> </tr> </thead> <tbody> <tr> <td>0,1</td> <td>Actual number of data points</td> </tr> <tr> <td>2,3</td> <td>Data point 0; Data set 1</td> </tr> <tr> <td>4,5</td> <td>Data point 0; Data set 2</td> </tr> <tr> <td>6,7</td> <td>Data point 1; Data set 1</td> </tr> <tr> <td>8,9</td> <td>Data point 1; Data set 2</td> </tr> <tr> <td>...</td> <td>...</td> </tr> <tr> <td>4n+2, 4n+3</td> <td>Data point n; Data set 1</td> </tr> <tr> <td>4n+4, 4n+5</td> <td>Data point n; Data set 2</td> </tr> </tbody> </table>	Word	Description	0,1	Actual number of data points	2,3	Data point 0; Data set 1	4,5	Data point 0; Data set 2	6,7	Data point 1; Data set 1	8,9	Data point 1; Data set 2	...	...	4n+2, 4n+3	Data point n; Data set 1	4n+4, 4n+5	Data point n; Data set 2												
	Word	Description																													
	0,1	Actual number of data points																													
2,3	Data point 0; Data set 1																														
4,5	Data point 0; Data set 2																														
6,7	Data point 1; Data set 1																														
8,9	Data point 1; Data set 2																														
...	...																														
4n+2, 4n+3	Data point n; Data set 1																														
4n+4, 4n+5	Data point n; Data set 2																														
Read Address	<p><b>Data Type: 32-bit; Number of Data Sets: 8</b></p> <table border="1"> <thead> <tr> <th>Word</th> <th>Description</th> </tr> </thead> <tbody> <tr> <td>0,1</td> <td>Actual number of data points</td> </tr> <tr> <td>2,3</td> <td>Data point 0; Data set 1</td> </tr> <tr> <td>4,5</td> <td>Data point 0; Data set 2</td> </tr> <tr> <td>6,7</td> <td>Data point 0; Data set 3</td> </tr> <tr> <td>8,9</td> <td>Data point 0; Data set 4</td> </tr> <tr> <td>10,11</td> <td>Data point 0; Data set 5</td> </tr> <tr> <td>12,13</td> <td>Data point 0; Data set 6</td> </tr> <tr> <td>14,15</td> <td>Data point 0; Data set 7</td> </tr> <tr> <td>16,17</td> <td>Data point 0; Data set 8</td> </tr> <tr> <td>18,19</td> <td>Data point 1; Data set 1</td> </tr> <tr> <td>20,21</td> <td>Data point 1; Data set 2</td> </tr> <tr> <td>...</td> <td>...</td> </tr> <tr> <td>16n+14, 16n+15</td> <td>Data point n; Data set 7</td> </tr> <tr> <td>16n+16, 16n+17</td> <td>Data point n; Data set 8</td> </tr> </tbody> </table>	Word	Description	0,1	Actual number of data points	2,3	Data point 0; Data set 1	4,5	Data point 0; Data set 2	6,7	Data point 0; Data set 3	8,9	Data point 0; Data set 4	10,11	Data point 0; Data set 5	12,13	Data point 0; Data set 6	14,15	Data point 0; Data set 7	16,17	Data point 0; Data set 8	18,19	Data point 1; Data set 1	20,21	Data point 1; Data set 2	...	...	16n+14, 16n+15	Data point n; Data set 7	16n+16, 16n+17	Data point n; Data set 8
	Word	Description																													
	0,1	Actual number of data points																													
2,3	Data point 0; Data set 1																														
4,5	Data point 0; Data set 2																														
6,7	Data point 0; Data set 3																														
8,9	Data point 0; Data set 4																														
10,11	Data point 0; Data set 5																														
12,13	Data point 0; Data set 6																														
14,15	Data point 0; Data set 7																														
16,17	Data point 0; Data set 8																														
18,19	Data point 1; Data set 1																														
20,21	Data point 1; Data set 2																														
...	...																														
16n+14, 16n+15	Data point n; Data set 7																														
16n+16, 16n+17	Data point n; Data set 8																														
Number of Data Sets	Specifies how many data sets that the line chart will read. The line chart displays one line for each data set. A line chart can display up to 8 lines.																														
Maximum Number of Data Points Per Data Set	Specifies the maximum number of data points that the line chart will read for every data set. A line chart can display up to 255 data points for one data set. <b>Note:</b> The actual number of data points for every data set must be specified at runtime. The actual number must not exceed the maximum number.																														

Continued







Property		Description																							
Point Distribution		<p>Select one of the following method to distribute the data points of a data set:</p> <table border="1"> <thead> <tr> <th>Method</th> <th>Description</th> </tr> </thead> <tbody> <tr> <td>Maximum Points</td> <td>The data points of a data set are evenly distributed across the X axis of the line chart based on the maximum number of data points for every data set. Therefore the space between two adjacent data points is fixed.</td> </tr> <tr> <td>Actual Points</td> <td>The data points of a data set are evenly distributed across the X axis of the line chart based on the actual number of data points. When the number of actual data points decreases, the space between two adjacent data points increases.</td> </tr> </tbody> </table>	Method	Description	Maximum Points	The data points of a data set are evenly distributed across the X axis of the line chart based on the maximum number of data points for every data set. Therefore the space between two adjacent data points is fixed.	Actual Points	The data points of a data set are evenly distributed across the X axis of the line chart based on the actual number of data points. When the number of actual data points decreases, the space between two adjacent data points increases.																	
Method	Description																								
Maximum Points	The data points of a data set are evenly distributed across the X axis of the line chart based on the maximum number of data points for every data set. Therefore the space between two adjacent data points is fixed.																								
Actual Points	The data points of a data set are evenly distributed across the X axis of the line chart based on the actual number of data points. When the number of actual data points decreases, the space between two adjacent data points increases.																								
Direction		Specifies the direction that the line chart draws the data points.																							
Show Mark		Check this option so the line chart will put a square mark on every data point.																							
Show Line		Check this option so the line chart will display a line connecting all the data points of a data set in sequence.																							
Clear Trigger		The bit variable that will trigger the line chart to clear its content when its state changes from off to on. Click  to enter an address for this field. Click  to select a tag for this field.																							
Cursor	Show Cursor	Check this option so the line chart will display a cursor. You can touch and drag the cursor to the data point(s) that you want to select.																							
	Cursor Color	Select a color for the cursor.																							
	Value Display Font	Select a font for displaying the values of the selected data point(s).																							
	Cursor Data Receiving Buffer	<p>The variable that will receive the value(s) of the selected data point(s). It must be a piece of the internal memory.</p> <p>Click  to enter an address for this field. Click  to select a tag for this field.</p> <p>The following table shows the data arrangement of the buffer when the data type is 16-bit.</p> <table border="1"> <thead> <tr> <th>Word</th> <th>Description</th> </tr> </thead> <tbody> <tr> <td>0</td> <td>The sequence number of the cursor selected data in the data set</td> </tr> <tr> <td>1</td> <td>The value of the selected data point of data set 1.</td> </tr> <tr> <td>2</td> <td>The value of the selected data point of data set 2.</td> </tr> <tr> <td>...</td> <td>...</td> </tr> <tr> <td>8</td> <td>The value of the selected data point of data set 8.</td> </tr> </tbody> </table> <p>The following table shows the data arrangement of the buffer when the data type is 32-bit.</p> <table border="1"> <thead> <tr> <th>Word</th> <th>Description</th> </tr> </thead> <tbody> <tr> <td>0,1</td> <td>The sequence number of the cursor selected data in the data set</td> </tr> <tr> <td>2,3</td> <td>The value of the selected data point of data set 1.</td> </tr> <tr> <td>4,5</td> <td>The value of the selected data point of data set 2.</td> </tr> <tr> <td>...</td> <td>...</td> </tr> <tr> <td>16,17</td> <td>The value of the selected data point of data set 8.</td> </tr> </tbody> </table>	Word	Description	0	The sequence number of the cursor selected data in the data set	1	The value of the selected data point of data set 1.	2	The value of the selected data point of data set 2.	...	...	8	The value of the selected data point of data set 8.	Word	Description	0,1	The sequence number of the cursor selected data in the data set	2,3	The value of the selected data point of data set 1.	4,5	The value of the selected data point of data set 2.	...	...	16,17
Word	Description																								
0	The sequence number of the cursor selected data in the data set																								
1	The value of the selected data point of data set 1.																								
2	The value of the selected data point of data set 2.																								
...	...																								
8	The value of the selected data point of data set 8.																								
Word	Description																								
0,1	The sequence number of the cursor selected data in the data set																								
2,3	The value of the selected data point of data set 1.																								
4,5	The value of the selected data point of data set 2.																								
...	...																								
16,17	The value of the selected data point of data set 8.																								

Continued



Property		Description																																															
Dynamic Range	Dynamic Range	Check this option so the minimum and the maximum of the pen for each data set will be specified at runtime. When this option is selected, the minimum and maximum of the marks for the X axis and Y axis can be specified at runtime too. The data that specifies the above two ranges should be set and arranged correctly in a memory block called the dynamic range parameter block. You need to specify the dynamic range parameter block in the Dynamic Range Parameter Block field.																																															
	Dynamic Range Parameter Block	<p>Specifies the variable that stores the dynamic range parameter block for the line chart when the Dynamic Range is selected. Click  to enter an address for this field. Click  to select a tag for this field.</p> <p>The following table shows the data arrangement of the parameter block when the data type is 16-bit.</p> <table border="1"> <thead> <tr> <th>Word</th> <th>Description</th> </tr> </thead> <tbody> <tr> <td>0,1</td> <td>The minimum of the mark for the X axis; 32-bit integer number</td> </tr> <tr> <td>2,3</td> <td>The maximum of the mark for the X axis; 32-bit integer number</td> </tr> <tr> <td>4,5</td> <td>The minimum of the mark for the Y axis; 32-bit integer number</td> </tr> <tr> <td>6,7</td> <td>The maximum of the mark for the Y axis; 32-bit integer number</td> </tr> <tr> <td>8</td> <td>The minimum for pen #1; 16-bit integer number or 16-bit unsigned integer number</td> </tr> <tr> <td>9</td> <td>The maximum for pen #1; (Same as above)</td> </tr> <tr> <td>10</td> <td>The minimum for pen #2; (Same as above)</td> </tr> <tr> <td>11</td> <td>The maximum for pen #2; (Same as above)</td> </tr> <tr> <td>...</td> <td>...</td> </tr> <tr> <td>22</td> <td>The minimum for pen #8; (Same as above)</td> </tr> <tr> <td>23</td> <td>The maximum for pen #8; (Same as above)</td> </tr> </tbody> </table> <p>The following table shows the data arrangement of the parameter block when the data type is 32-bit.</p> <table border="1"> <thead> <tr> <th>Word</th> <th>Description</th> </tr> </thead> <tbody> <tr> <td>0,1</td> <td>The minimum of the mark for the X axis; 32-bit integer number</td> </tr> <tr> <td>2,3</td> <td>The maximum of the mark for the X axis; 32-bit integer number</td> </tr> <tr> <td>4,5</td> <td>The minimum of the mark for the Y axis; 32-bit integer number</td> </tr> <tr> <td>6,7</td> <td>The maximum of the mark for the Y axis; 32-bit integer number</td> </tr> <tr> <td>8,9</td> <td>The minimum for pen #1; 32-bit integer number, 32-bit unsigned integer number, or 32-bit floating point number</td> </tr> <tr> <td>10,11</td> <td>The maximum for pen #1; (Same as above)</td> </tr> <tr> <td>12,13</td> <td>The minimum for pen #2; (Same as above)</td> </tr> <tr> <td>14,15</td> <td>The maximum for pen #2; (Same as above)</td> </tr> <tr> <td>...</td> <td>...</td> </tr> <tr> <td>36,37</td> <td>The minimum for pen #8; (Same as above)</td> </tr> <tr> <td>38,39</td> <td>The maximum for pen #8; (Same as above)</td> </tr> </tbody> </table>	Word	Description	0,1	The minimum of the mark for the X axis; 32-bit integer number	2,3	The maximum of the mark for the X axis; 32-bit integer number	4,5	The minimum of the mark for the Y axis; 32-bit integer number	6,7	The maximum of the mark for the Y axis; 32-bit integer number	8	The minimum for pen #1; 16-bit integer number or 16-bit unsigned integer number	9	The maximum for pen #1; (Same as above)	10	The minimum for pen #2; (Same as above)	11	The maximum for pen #2; (Same as above)	...	...	22	The minimum for pen #8; (Same as above)	23	The maximum for pen #8; (Same as above)	Word	Description	0,1	The minimum of the mark for the X axis; 32-bit integer number	2,3	The maximum of the mark for the X axis; 32-bit integer number	4,5	The minimum of the mark for the Y axis; 32-bit integer number	6,7	The maximum of the mark for the Y axis; 32-bit integer number	8,9	The minimum for pen #1; 32-bit integer number, 32-bit unsigned integer number, or 32-bit floating point number	10,11	The maximum for pen #1; (Same as above)	12,13	The minimum for pen #2; (Same as above)	14,15	The maximum for pen #2; (Same as above)	...	...	36,37	The minimum for pen #8; (Same as above)	38,39
Word	Description																																																
0,1	The minimum of the mark for the X axis; 32-bit integer number																																																
2,3	The maximum of the mark for the X axis; 32-bit integer number																																																
4,5	The minimum of the mark for the Y axis; 32-bit integer number																																																
6,7	The maximum of the mark for the Y axis; 32-bit integer number																																																
8	The minimum for pen #1; 16-bit integer number or 16-bit unsigned integer number																																																
9	The maximum for pen #1; (Same as above)																																																
10	The minimum for pen #2; (Same as above)																																																
11	The maximum for pen #2; (Same as above)																																																
...	...																																																
22	The minimum for pen #8; (Same as above)																																																
23	The maximum for pen #8; (Same as above)																																																
Word	Description																																																
0,1	The minimum of the mark for the X axis; 32-bit integer number																																																
2,3	The maximum of the mark for the X axis; 32-bit integer number																																																
4,5	The minimum of the mark for the Y axis; 32-bit integer number																																																
6,7	The maximum of the mark for the Y axis; 32-bit integer number																																																
8,9	The minimum for pen #1; 32-bit integer number, 32-bit unsigned integer number, or 32-bit floating point number																																																
10,11	The maximum for pen #1; (Same as above)																																																
12,13	The minimum for pen #2; (Same as above)																																																
14,15	The maximum for pen #2; (Same as above)																																																
...	...																																																
36,37	The minimum for pen #8; (Same as above)																																																
38,39	The maximum for pen #8; (Same as above)																																																

### 8.4.5. Pen Settings

This section describes how to define the pens for the line charts. The following is an example of the Pen page.

The screenshot shows the 'Pen' tab of a settings dialog. It contains eight panels, one for each pen (Pen #1 to Pen #8). Each panel has the following controls:

- Dynamic Range:** A checkbox. Pen #3 and Pen #4 are checked; others are unchecked.
- Min.:** A text input field, all set to '0'.
- Max.:** A text input field, all set to '100'.
- Mark Size:** A spinner control. Pen #1 and #2 are set to 4; Pen #3, #4, #5, #6, #7, and #8 are set to 2.
- Line Style:** A dropdown menu showing a solid line style.
- Color:** A color selection box with a small color swatch.
- Show Value:** A dropdown menu. Pen #3 and #4 are set to 'Scaled'; Pen #1, #2, #5, #6, #7, and #8 are set to 'Original' or '(None)'.

The following table describes each property in the Pen page. Note that pen #1 is for data set 1; pen #2 is for data set 2; and so on.

Property		Description							
Pen #1 ~ Pen #8	Dynamic Range	Check this option so the minimum and the maximum of the associated data set will be specified at runtime. This option is available when the Dynamic Range option in the General page is selected.							
	Min.	The minimum of the associated data set. This property is available when the Dynamic Range option is not selected.							
	Max.	The maximum of the associated data set. This property is available when the Dynamic Range option is not selected.							
	Mark Size	Select a size for the data point mark. The selection is valid when the Show Mark option in the General page is selected.							
	Line Style	Select a style for the connecting lines. The selection is valid when the Show Line option in the General page is selected.							
	Color	Select a color for the connecting lines.							
	Show Value	Select one of the following methods for displaying the selected data point value. <table border="1" style="width: 100%; margin-top: 5px;"> <thead> <tr> <th>Show Value</th> <th>Description</th> </tr> </thead> <tbody> <tr> <td>(None)</td> <td>Does not display the data point value.</td> </tr> <tr> <td>Original</td> <td>Displays the data point value without modification.</td> </tr> <tr> <td>Scaled</td> <td>Displays the corresponding Y axis value of the data point.</td> </tr> </tbody> </table> The selection is valid when the Show Cursor option in the General page is selected.	Show Value	Description	(None)	Does not display the data point value.	Original	Displays the data point value without modification.	Scaled
Show Value	Description								
(None)	Does not display the data point value.								
Original	Displays the data point value without modification.								
Scaled	Displays the corresponding Y axis value of the data point.								

### 8.4.6. Axis Settings

This section describes how to define the X axis and the Y axis for the line charts and the scatter charts.

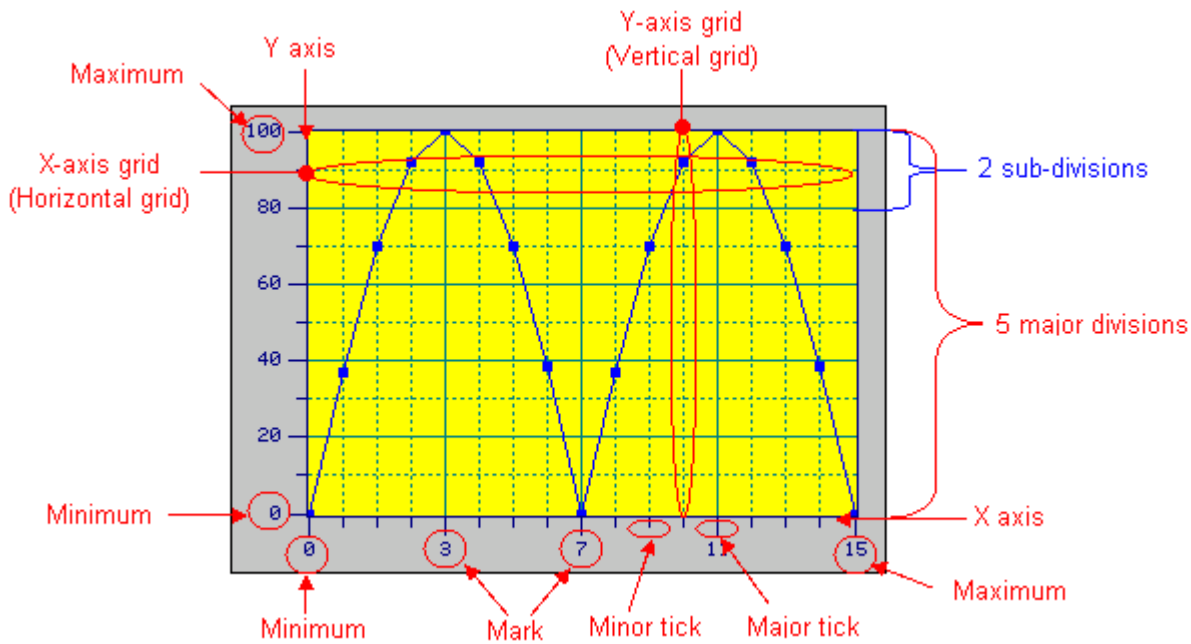

The following is an example of the Axis page.

General Pen **Axis** Visibility

**X Axis**

Show Ticks

Show Y-Axis Grid

Axis/Tick Color:  

Grid Color:  

Number of Major Divisions:

Number of Sub-divisions:

Show Marks

Font:  6x8  8x12  12x16

Dynamic Range

Min.:  Max.:

Total Digits:

Fractional Digits:

**Y Axis**

Show Ticks

Show X-Axis Grid

Axis/Tick Color:  

Grid Color:  

Number of Major Divisions:

Number of Sub-divisions:

Show Marks

Font:  6x8  8x12  12x16

Dynamic Range

Min.:  Max.:

Total Digits:

Fractional Digits:



The following table describes each property in the Axis page.

Property		Description
X Axis	Show Ticks	Check this option if you want the X axis to have ticks.
	Show Y-axis Grid	Select this option if you want the X axis to have vertical grids.
	Axis/Tick Color	Select a color for the X axis and its ticks.
	Grid Color	Select a color for the vertical grids.
	Number of Major Divisions	The number of major divisions for the X axis. The minimum you can specify is one.
	Number of Sub-divisions	The number of divisions between two adjacent major ticks. The minimum you can specify is one.
Mark	Show Marks	Check this option if you want the major ticks to have marks.
	Font	The font of the marks.
	Dynamic Range	Check this option if you want the minimum and maximum of the marks to be controlled by the dynamic range parameter block of the associated object at runtime.
	Min.	The minimum of the marks. It is a 32-bit integer.
	Max.	The maximum of the marks. It is a 32-bit integer.
	Total Digits	The total digits to be displayed for the marks.
	Fractional Digits	The number of fractional digits for the marks. For example, when the Maximum is 5000, the Total Digits is 4, and the Fractional Digits is 2, the mark for the Maximum will be 50.00.
Y Axis	Show Ticks	Check this option if you want the Y axis to have ticks.
	Show X-axis Grid	Select this option if you want the Y axis to have horizontal grids.
	Axis/Tick Color	Select a color for the Y axis and its ticks.
	Grid Color	Select a color for the horizontal grids.
	Number of Major Divisions	The number of major divisions for the Y axis. The minimum you can specify is one.
	Number of Sub-divisions	The number of divisions between two adjacent major ticks. The minimum you can specify is one.
Mark	Show Marks	Check this option if you want the major ticks to have marks.
	Font	The font of the marks.
	Dynamic Range	Check this option if you want the minimum and maximum of the marks to be controlled by the dynamic range parameter block of the associated object at runtime.
	Min.	The minimum of the marks. You can specify a 32-bit signed integer.
	Max.	The maximum of the marks. You can specify a 32-bit signed integer.
	Total Digits	The total digits to be displayed for the marks.
	Fractional Digits	The number of fractional digits for the marks. For example, when the Maximum is 5000, the Total Digits is 4, and the Fractional Digits is 2, the mark for the Maximum will be 50.00.

## 8.5. Scatter Charts

### 8.5.1. Basic Operations

A scatter chart displays a set of data by drawing a data point for each datum and drawing a line that connects all the data points in sequence. Each datum is a coordinate that contains an X value and a Y value. The vertical position of a data point is determined by the X value of the associated datum. The horizontal position of a data point is determined by the Y value of the associated datum.

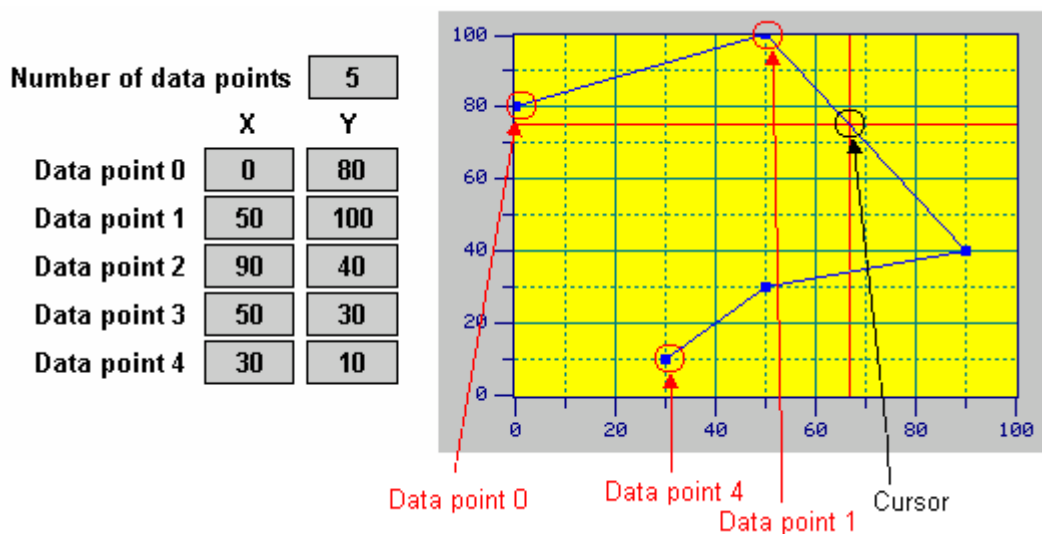

A scatter chart can display up to 8 sets of data. The following example shows a scatter chart that displays 3 sets of data.

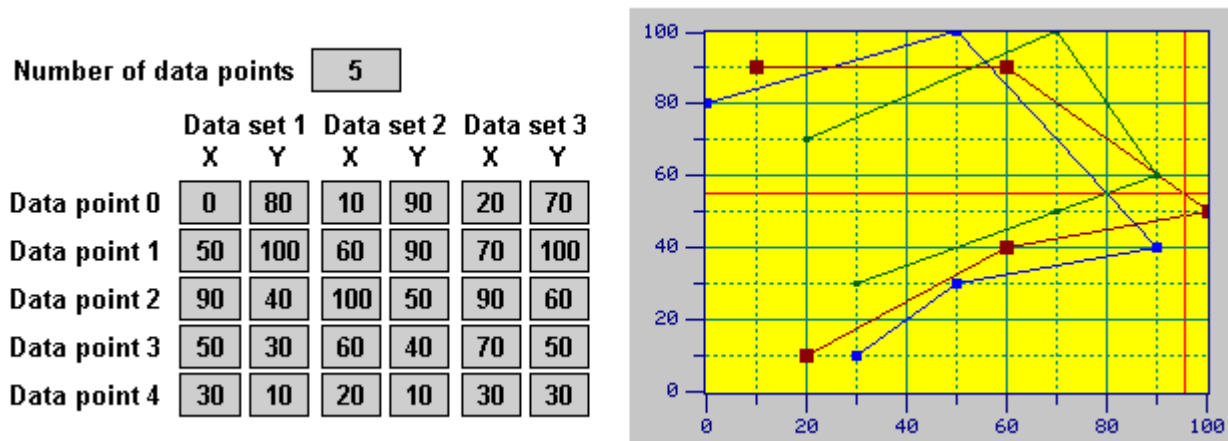

### 8.5.2. Operation Options

The following operation option can be added to a scatter chart. Select and set the option in the Scatter Chart dialog box.

Options	Description
Visibility Control	You can show and hide a scatter chart by a specified bit or the current user level. Select and set this option in the Visibility page.



### 8.5.3. Settings

You can complete all the settings of a scatter chart in the Scatter Chart dialog box. This dialog box contains the following four pages.

- **General**

Described in [Section 8.5.4.](#)

- **Pen**

Described in [Section 8.5.5.](#)

- **XY Axis**

Described in [Section 8.4.6.](#)

- **Visibility**

Described in [Section 4.3.4.](#)



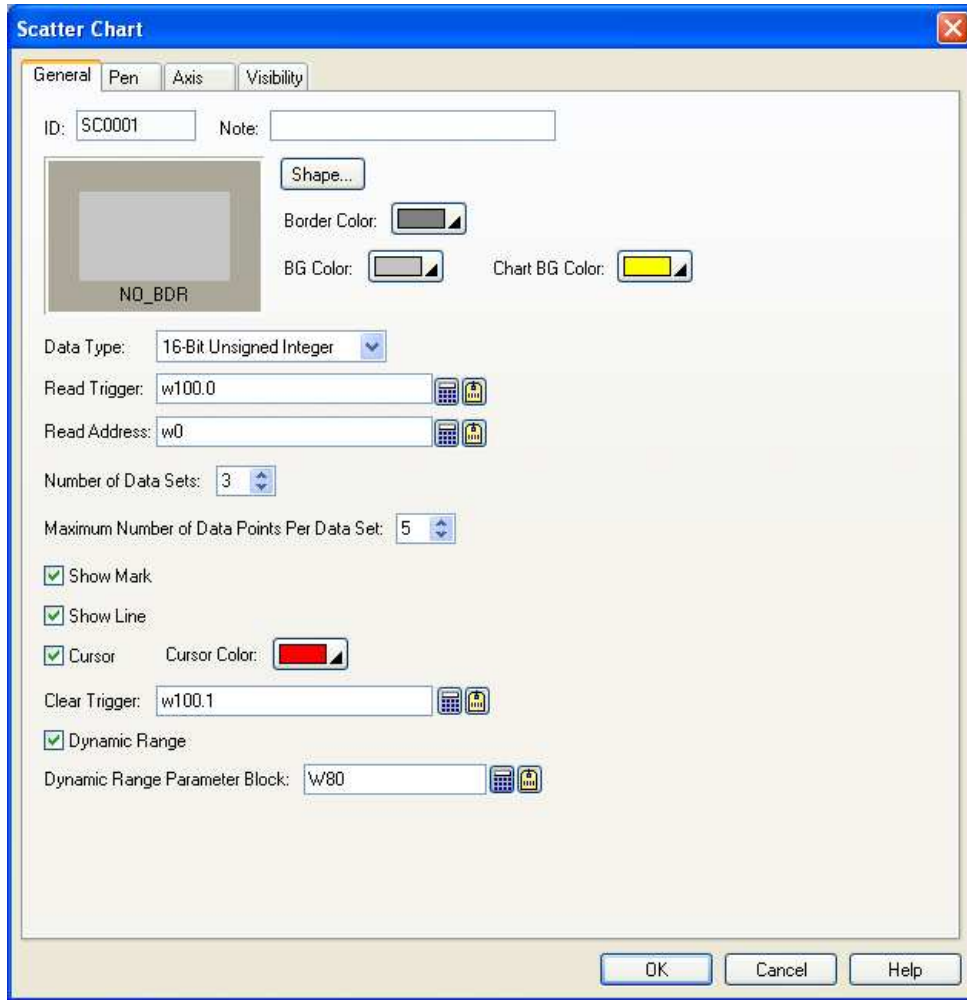

### 8.5.4. General Settings

This section describes how to define the general settings for a scatter chart. The following is an example of the General page of the Scatter Chart property sheet.





The following table describes each property in the General page.

Property	Description
ID	The object's identifier. It is generated when the object is created. The identifier is unique within the screen where the object is on. The format of the ID's for the scatter charts is SCnnnn.
Note	You can type a note for the object.
Shape settings	For details about the following properties, see <a href="#">Section 4.3.1.4 Setting up the Shape of an Object.</a>  , Border Color, BG Color
Chart BG Color	Select a color for the background of the char.
Data Type	The type of the data that the scatter chart will display. The supported data types include: 16-Bit Unsigned Integer, 32-Bit Unsigned Integer, 16-Bit Signed Integer, 32-Bit Signed Integer, 16-Bit BCD, 32-Bit BCD, 32-Bit Floating Point, 16-Bit Signed BCD (LMB), 32-Bit Signed BCD (LMB), 16-Bit Signed BCD (LMD), and 32-Bit Signed BCD (LMD).
Read Trigger	The bit variable that will trigger the scatter chart to read and display data. The bit variable triggers the scatter chart when its state changes from off to on. Click  to enter an address for this field. Click  to select a tag for this field.







Property	Description																																																																																												
Read Address	<p>The variable whose data is to be read and displayed. Click  to enter an address for this field. Click  to select a tag for this field.</p> <p>The following tables show the data arrangements of the variable.</p> <p><b>Data Type: 16-bit; Number of Data Sets: 1</b></p> <table border="1" data-bbox="300 405 898 788"> <thead> <tr> <th>Word</th> <th>Description</th> </tr> </thead> <tbody> <tr><td>0</td><td>Actual number of data points</td></tr> <tr><td>1</td><td>X value of data point 0</td></tr> <tr><td>2</td><td>Y value of data point 0</td></tr> <tr><td>3</td><td>X value of data point 1</td></tr> <tr><td>4</td><td>Y value of data point 1</td></tr> <tr><td>...</td><td>...</td></tr> <tr><td>2n+1</td><td>X value of data point n</td></tr> <tr><td>2n+2</td><td>Y value of data point n</td></tr> </tbody> </table> <p><b>Data Type: 16-bit; Number of Data Sets: 2</b></p> <table border="1" data-bbox="300 866 898 1420"> <thead> <tr> <th>Word</th> <th>Description</th> </tr> </thead> <tbody> <tr><td>0</td><td>Actual number of data points</td></tr> <tr><td>1</td><td>X value of data point 0; Data set 1</td></tr> <tr><td>2</td><td>Y value of data point 0; Data set 1</td></tr> <tr><td>3</td><td>X value of data point 0; Data set 2</td></tr> <tr><td>4</td><td>Y value of data point 0; Data set 2</td></tr> <tr><td>5</td><td>X value of data point 1; Data set 1</td></tr> <tr><td>6</td><td>Y value of data point 1; Data set 1</td></tr> <tr><td>7</td><td>X value of data point 1; Data set 2</td></tr> <tr><td>8</td><td>Y value of data point 1; Data set 2</td></tr> <tr><td>...</td><td>...</td></tr> <tr><td>4n+3</td><td>X value of data point n; Data set 2</td></tr> <tr><td>4n+4</td><td>Y value of data point n; Data set 2</td></tr> </tbody> </table> <p><b>Data Type: 16-bit; Number of Data Sets: 8</b></p> <table border="1" data-bbox="300 1498 1471 2009"> <thead> <tr> <th>Word</th> <th>Description</th> <th>Word</th> <th>Description</th> </tr> </thead> <tbody> <tr><td>0</td><td>Actual number of data points</td><td>11</td><td>X value of data point 0; Data set 6</td></tr> <tr><td>1</td><td>X value of data point 0; Data set 1</td><td>12</td><td>Y value of data point 0; Data set 6</td></tr> <tr><td>2</td><td>Y value of data point 0; Data set 1</td><td>13</td><td>X value of data point 0; Data set 7</td></tr> <tr><td>3</td><td>X value of data point 0; Data set 2</td><td>14</td><td>Y value of data point 0; Data set 7</td></tr> <tr><td>4</td><td>Y value of data point 0; Data set 2</td><td>15</td><td>X value of data point 0; Data set 8</td></tr> <tr><td>5</td><td>X value of data point 0; Data set 3</td><td>16</td><td>Y value of data point 0; Data set 8</td></tr> <tr><td>6</td><td>Y value of data point 0; Data set 3</td><td>17</td><td>X value of data point 1; Data set 1</td></tr> <tr><td>7</td><td>X value of data point 0; Data set 4</td><td>18</td><td>Y value of data point 1; Data set 1</td></tr> <tr><td>8</td><td>Y value of data point 0; Data set 4</td><td>...</td><td>...</td></tr> <tr><td>9</td><td>X value of data point 0; Data set 5</td><td>16n+15</td><td>X value of data point n; Data set 8</td></tr> <tr><td>10</td><td>Y value of data point 0; Data set 5</td><td>16n+16</td><td>Y value of data point n; Data set 8</td></tr> </tbody> </table>	Word	Description	0	Actual number of data points	1	X value of data point 0	2	Y value of data point 0	3	X value of data point 1	4	Y value of data point 1	...	...	2n+1	X value of data point n	2n+2	Y value of data point n	Word	Description	0	Actual number of data points	1	X value of data point 0; Data set 1	2	Y value of data point 0; Data set 1	3	X value of data point 0; Data set 2	4	Y value of data point 0; Data set 2	5	X value of data point 1; Data set 1	6	Y value of data point 1; Data set 1	7	X value of data point 1; Data set 2	8	Y value of data point 1; Data set 2	...	...	4n+3	X value of data point n; Data set 2	4n+4	Y value of data point n; Data set 2	Word	Description	Word	Description	0	Actual number of data points	11	X value of data point 0; Data set 6	1	X value of data point 0; Data set 1	12	Y value of data point 0; Data set 6	2	Y value of data point 0; Data set 1	13	X value of data point 0; Data set 7	3	X value of data point 0; Data set 2	14	Y value of data point 0; Data set 7	4	Y value of data point 0; Data set 2	15	X value of data point 0; Data set 8	5	X value of data point 0; Data set 3	16	Y value of data point 0; Data set 8	6	Y value of data point 0; Data set 3	17	X value of data point 1; Data set 1	7	X value of data point 0; Data set 4	18	Y value of data point 1; Data set 1	8	Y value of data point 0; Data set 4	...	...	9	X value of data point 0; Data set 5	16n+15	X value of data point n; Data set 8	10	Y value of data point 0; Data set 5	16n+16	Y value of data point n; Data set 8
Word	Description																																																																																												
0	Actual number of data points																																																																																												
1	X value of data point 0																																																																																												
2	Y value of data point 0																																																																																												
3	X value of data point 1																																																																																												
4	Y value of data point 1																																																																																												
...	...																																																																																												
2n+1	X value of data point n																																																																																												
2n+2	Y value of data point n																																																																																												
Word	Description																																																																																												
0	Actual number of data points																																																																																												
1	X value of data point 0; Data set 1																																																																																												
2	Y value of data point 0; Data set 1																																																																																												
3	X value of data point 0; Data set 2																																																																																												
4	Y value of data point 0; Data set 2																																																																																												
5	X value of data point 1; Data set 1																																																																																												
6	Y value of data point 1; Data set 1																																																																																												
7	X value of data point 1; Data set 2																																																																																												
8	Y value of data point 1; Data set 2																																																																																												
...	...																																																																																												
4n+3	X value of data point n; Data set 2																																																																																												
4n+4	Y value of data point n; Data set 2																																																																																												
Word	Description	Word	Description																																																																																										
0	Actual number of data points	11	X value of data point 0; Data set 6																																																																																										
1	X value of data point 0; Data set 1	12	Y value of data point 0; Data set 6																																																																																										
2	Y value of data point 0; Data set 1	13	X value of data point 0; Data set 7																																																																																										
3	X value of data point 0; Data set 2	14	Y value of data point 0; Data set 7																																																																																										
4	Y value of data point 0; Data set 2	15	X value of data point 0; Data set 8																																																																																										
5	X value of data point 0; Data set 3	16	Y value of data point 0; Data set 8																																																																																										
6	Y value of data point 0; Data set 3	17	X value of data point 1; Data set 1																																																																																										
7	X value of data point 0; Data set 4	18	Y value of data point 1; Data set 1																																																																																										
8	Y value of data point 0; Data set 4	...	...																																																																																										
9	X value of data point 0; Data set 5	16n+15	X value of data point n; Data set 8																																																																																										
10	Y value of data point 0; Data set 5	16n+16	Y value of data point n; Data set 8																																																																																										



Continued



Property	Description																																																
Read Address	<b>Data Type: 32-bit; Number of Data Sets: 1</b>																																																
	<table border="1"> <thead> <tr> <th>Word</th> <th>Description</th> <th>Word</th> <th>Description</th> </tr> </thead> <tbody> <tr> <td>0,1</td> <td>Actual number of data points</td> <td>8,9</td> <td>Y value of data point 1</td> </tr> <tr> <td>2,3</td> <td>X value of data point 0</td> <td>...</td> <td>...</td> </tr> <tr> <td>4,5</td> <td>Y value of data point 0</td> <td>4n+2, 4n+3</td> <td>X value of data point n</td> </tr> <tr> <td>6,7</td> <td>X value of data point 1</td> <td>4n+4, 4n+5</td> <td>Y value of data point n</td> </tr> </tbody> </table>	Word	Description	Word	Description	0,1	Actual number of data points	8,9	Y value of data point 1	2,3	X value of data point 0	...	...	4,5	Y value of data point 0	4n+2, 4n+3	X value of data point n	6,7	X value of data point 1	4n+4, 4n+5	Y value of data point n																												
	Word	Description	Word	Description																																													
	0,1	Actual number of data points	8,9	Y value of data point 1																																													
	2,3	X value of data point 0	...	...																																													
	4,5	Y value of data point 0	4n+2, 4n+3	X value of data point n																																													
	6,7	X value of data point 1	4n+4, 4n+5	Y value of data point n																																													
	<b>Data Type: 32-bit; Number of Data Sets: 2</b>																																																
	<table border="1"> <thead> <tr> <th>Word</th> <th>Description</th> <th>Word</th> <th>Description</th> </tr> </thead> <tbody> <tr> <td>0,1</td> <td>Actual number of data points</td> <td>12,13</td> <td>Y value of data point 1; Data set 1</td> </tr> <tr> <td>2,3</td> <td>X value of data point 0; Data set 1</td> <td>14,15</td> <td>X value of data point 1; Data set 2</td> </tr> <tr> <td>4,5</td> <td>Y value of data point 0; Data set 1</td> <td>16,17</td> <td>Y value of data point 1; Data set 2</td> </tr> <tr> <td>6,7</td> <td>X value of data point 0; Data set 2</td> <td>...</td> <td>...</td> </tr> <tr> <td>8,9</td> <td>Y value of data point 0; Data set 2</td> <td>8n+6, 8n+7</td> <td>X value of data point n; Data set 2</td> </tr> <tr> <td>10,11</td> <td>X value of data point 1; Data set 1</td> <td>8n+8, 8n+9</td> <td>Y value of data point n; Data set 2</td> </tr> </tbody> </table>	Word	Description	Word	Description	0,1	Actual number of data points	12,13	Y value of data point 1; Data set 1	2,3	X value of data point 0; Data set 1	14,15	X value of data point 1; Data set 2	4,5	Y value of data point 0; Data set 1	16,17	Y value of data point 1; Data set 2	6,7	X value of data point 0; Data set 2	...	...	8,9	Y value of data point 0; Data set 2	8n+6, 8n+7	X value of data point n; Data set 2	10,11	X value of data point 1; Data set 1	8n+8, 8n+9	Y value of data point n; Data set 2																				
	Word	Description	Word	Description																																													
	0,1	Actual number of data points	12,13	Y value of data point 1; Data set 1																																													
	2,3	X value of data point 0; Data set 1	14,15	X value of data point 1; Data set 2																																													
	4,5	Y value of data point 0; Data set 1	16,17	Y value of data point 1; Data set 2																																													
	6,7	X value of data point 0; Data set 2	...	...																																													
	8,9	Y value of data point 0; Data set 2	8n+6, 8n+7	X value of data point n; Data set 2																																													
	10,11	X value of data point 1; Data set 1	8n+8, 8n+9	Y value of data point n; Data set 2																																													
	<b>Data Type: 32-bit; Number of Data Sets: 8</b>																																																
	<table border="1"> <thead> <tr> <th>Word</th> <th>Description</th> <th>Word</th> <th>Description</th> </tr> </thead> <tbody> <tr> <td>0,1</td> <td>Actual number of data points</td> <td>22,23</td> <td>X value of data point 0; Data set 6</td> </tr> <tr> <td>2,3</td> <td>X value of data point 0; Data set 1</td> <td>24,25</td> <td>Y value of data point 0; Data set 6</td> </tr> <tr> <td>4,5</td> <td>Y value of data point 0; Data set 1</td> <td>26,27</td> <td>X value of data point 0; Data set 7</td> </tr> <tr> <td>6,7</td> <td>X value of data point 0; Data set 2</td> <td>28,29</td> <td>Y value of data point 0; Data set 7</td> </tr> <tr> <td>8,9</td> <td>Y value of data point 0; Data set 2</td> <td>30,31</td> <td>X value of data point 0; Data set 8</td> </tr> <tr> <td>10,11</td> <td>X value of data point 0; Data set 3</td> <td>32,33</td> <td>Y value of data point 0; Data set 8</td> </tr> <tr> <td>12,13</td> <td>Y value of data point 0; Data set 3</td> <td>34,35</td> <td>X value of data point 1; Data set 1</td> </tr> <tr> <td>14,15</td> <td>X value of data point 0; Data set 4</td> <td>36,37</td> <td>Y value of data point 1; Data set 1</td> </tr> <tr> <td>16,17</td> <td>Y value of data point 0; Data set 4</td> <td>...</td> <td>...</td> </tr> <tr> <td>18,19</td> <td>X value of data point 0; Data set 5</td> <td>32n+30, 32n+31</td> <td>X value of data point n; Data set 8</td> </tr> <tr> <td>20,21</td> <td>Y value of data point 0; Data set 5</td> <td>32n+32, 32n+33</td> <td>Y value of data point n; Data set 8</td> </tr> </tbody> </table>	Word	Description	Word	Description	0,1	Actual number of data points	22,23	X value of data point 0; Data set 6	2,3	X value of data point 0; Data set 1	24,25	Y value of data point 0; Data set 6	4,5	Y value of data point 0; Data set 1	26,27	X value of data point 0; Data set 7	6,7	X value of data point 0; Data set 2	28,29	Y value of data point 0; Data set 7	8,9	Y value of data point 0; Data set 2	30,31	X value of data point 0; Data set 8	10,11	X value of data point 0; Data set 3	32,33	Y value of data point 0; Data set 8	12,13	Y value of data point 0; Data set 3	34,35	X value of data point 1; Data set 1	14,15	X value of data point 0; Data set 4	36,37	Y value of data point 1; Data set 1	16,17	Y value of data point 0; Data set 4	...	...	18,19	X value of data point 0; Data set 5	32n+30, 32n+31	X value of data point n; Data set 8	20,21	Y value of data point 0; Data set 5	32n+32, 32n+33	Y value of data point n; Data set 8
	Word	Description	Word	Description																																													
	0,1	Actual number of data points	22,23	X value of data point 0; Data set 6																																													
	2,3	X value of data point 0; Data set 1	24,25	Y value of data point 0; Data set 6																																													
	4,5	Y value of data point 0; Data set 1	26,27	X value of data point 0; Data set 7																																													
	6,7	X value of data point 0; Data set 2	28,29	Y value of data point 0; Data set 7																																													
	8,9	Y value of data point 0; Data set 2	30,31	X value of data point 0; Data set 8																																													
	10,11	X value of data point 0; Data set 3	32,33	Y value of data point 0; Data set 8																																													
	12,13	Y value of data point 0; Data set 3	34,35	X value of data point 1; Data set 1																																													
	14,15	X value of data point 0; Data set 4	36,37	Y value of data point 1; Data set 1																																													
	16,17	Y value of data point 0; Data set 4	...	...																																													
	18,19	X value of data point 0; Data set 5	32n+30, 32n+31	X value of data point n; Data set 8																																													
	20,21	Y value of data point 0; Data set 5	32n+32, 32n+33	Y value of data point n; Data set 8																																													
	Number of Data Sets	Specifies how many data sets that the scatter chart will display. A scatter chart can display up to 8 sets of data.																																															
	Maximum Number of Data Points Per Data Set	Specifies the maximum number of data points that the scatter chart will display for every data set. A scatter chart can display up to 255 data points for one data set. <b>Note:</b> The actual number of data points for every data set is specified at runtime. The actual number must not exceed the maximum number.																																															
	Show Mark	Check this option so the scatter chart will show a square mark on every data point.																																															
Show Line	Check this option so the scatter chart will display a line between two adjacent data points of a data set.																																																
Clear Trigger	The bit variable that triggers the scatter chart to clear its content when its state changes from off to on. Click  to enter an address for this field. Click  to select a tag for this field.																																																

Continued



Property		Description																																																							
Cursor	Show Cursor	Check this option so the scatter chart will display a cursor. You can touch and drag the cursor within the chart.																																																							
	Cursor Color	Select a color for the cursor.																																																							
Dynamic Range	Dynamic Range	Check this option so the minimum and the maximum for the X and Y values of each data set can be specified at runtime. When this option is selected, the minimum and maximum of the marks for the X axis and Y axis can be specified at runtime too. The data that specifies the above two ranges should be set and arranged correctly in a memory block called the dynamic range parameter block. You need to specify the dynamic range parameter block in the Dynamic Range Parameter Block field.																																																							
	Dynamic Range Parameter Block	<p>Specifies the variable that stores the dynamic range parameter block for the line chart when the Dynamic Range is selected.</p> <p>Click  to enter an address for this field. Click  to select a tag for this field.</p> <p>The following table shows the data arrangement of the parameter block when the data type is 16-bit.</p> <table border="1"> <thead> <tr> <th>Word</th> <th>Description</th> </tr> </thead> <tbody> <tr> <td>0,1</td> <td>The minimum of the mark for the X axis; 32-bit integer number</td> </tr> <tr> <td>2,3</td> <td>The maximum of the mark for the X axis; 32-bit integer number</td> </tr> <tr> <td>4,5</td> <td>The minimum of the mark for the Y axis; 32-bit integer number</td> </tr> <tr> <td>6,7</td> <td>The maximum of the mark for the Y axis; 32-bit integer number</td> </tr> <tr> <td>8</td> <td>The minimum of X values for pen #1; 16-bit integer number or 16-bit unsigned integer number</td> </tr> <tr> <td>9</td> <td>The maximum of X values for pen #1; (Same as above)</td> </tr> <tr> <td>10</td> <td>The minimum of Y values for pen #1; (Same as above)</td> </tr> <tr> <td>11</td> <td>The maximum of Y values for pen #1; (Same as above)</td> </tr> <tr> <td>12</td> <td>The minimum of X values for pen #2; (Same as above)</td> </tr> <tr> <td>13</td> <td>The maximum of X values for pen #2; (Same as above)</td> </tr> <tr> <td>...</td> <td>...</td> </tr> <tr> <td>38</td> <td>The minimum of Y values for pen #8; (Same as above)</td> </tr> <tr> <td>39</td> <td>The maximum of Y values for pen #8; (Same as above)</td> </tr> </tbody> </table> <p>The following table shows the data arrangement of the parameter block when the data type is 32-bit.</p> <table border="1"> <thead> <tr> <th>Word</th> <th>Description</th> </tr> </thead> <tbody> <tr> <td>0,1</td> <td>The minimum of the mark for the X axis; 32-bit integer number</td> </tr> <tr> <td>2,3</td> <td>The maximum of the mark for the X axis; 32-bit integer number</td> </tr> <tr> <td>4,5</td> <td>The minimum of the mark for the Y axis; 32-bit integer number</td> </tr> <tr> <td>6,7</td> <td>The maximum of the mark for the Y axis; 32-bit integer number</td> </tr> <tr> <td>8,9</td> <td>The minimum of X values for pen #1; 32-bit integer number, 32-bit unsigned integer number, or 32-bit floating point number</td> </tr> <tr> <td>10,11</td> <td>The maximum of X values for pen #1; (Same as above)</td> </tr> <tr> <td>12,13</td> <td>The minimum of Y values for pen #1; (Same as above)</td> </tr> <tr> <td>14,15</td> <td>The maximum of Y values for pen #1; (Same as above)</td> </tr> <tr> <td>...</td> <td>...</td> </tr> <tr> <td>64,65</td> <td>The minimum of X values for pen #8; (Same as above)</td> </tr> <tr> <td>66,67</td> <td>The maximum of X values for pen #8; (Same as above)</td> </tr> <tr> <td>68,69</td> <td>The minimum of Y values for pen #8; (Same as above)</td> </tr> <tr> <td>70,71</td> <td>The maximum of Y values for pen #8; (Same as above)</td> </tr> </tbody> </table>	Word	Description	0,1	The minimum of the mark for the X axis; 32-bit integer number	2,3	The maximum of the mark for the X axis; 32-bit integer number	4,5	The minimum of the mark for the Y axis; 32-bit integer number	6,7	The maximum of the mark for the Y axis; 32-bit integer number	8	The minimum of X values for pen #1; 16-bit integer number or 16-bit unsigned integer number	9	The maximum of X values for pen #1; (Same as above)	10	The minimum of Y values for pen #1; (Same as above)	11	The maximum of Y values for pen #1; (Same as above)	12	The minimum of X values for pen #2; (Same as above)	13	The maximum of X values for pen #2; (Same as above)	...	...	38	The minimum of Y values for pen #8; (Same as above)	39	The maximum of Y values for pen #8; (Same as above)	Word	Description	0,1	The minimum of the mark for the X axis; 32-bit integer number	2,3	The maximum of the mark for the X axis; 32-bit integer number	4,5	The minimum of the mark for the Y axis; 32-bit integer number	6,7	The maximum of the mark for the Y axis; 32-bit integer number	8,9	The minimum of X values for pen #1; 32-bit integer number, 32-bit unsigned integer number, or 32-bit floating point number	10,11	The maximum of X values for pen #1; (Same as above)	12,13	The minimum of Y values for pen #1; (Same as above)	14,15	The maximum of Y values for pen #1; (Same as above)	...	...	64,65	The minimum of X values for pen #8; (Same as above)	66,67	The maximum of X values for pen #8; (Same as above)	68,69	The minimum of Y values for pen #8; (Same as above)	70,71
Word	Description																																																								
0,1	The minimum of the mark for the X axis; 32-bit integer number																																																								
2,3	The maximum of the mark for the X axis; 32-bit integer number																																																								
4,5	The minimum of the mark for the Y axis; 32-bit integer number																																																								
6,7	The maximum of the mark for the Y axis; 32-bit integer number																																																								
8	The minimum of X values for pen #1; 16-bit integer number or 16-bit unsigned integer number																																																								
9	The maximum of X values for pen #1; (Same as above)																																																								
10	The minimum of Y values for pen #1; (Same as above)																																																								
11	The maximum of Y values for pen #1; (Same as above)																																																								
12	The minimum of X values for pen #2; (Same as above)																																																								
13	The maximum of X values for pen #2; (Same as above)																																																								
...	...																																																								
38	The minimum of Y values for pen #8; (Same as above)																																																								
39	The maximum of Y values for pen #8; (Same as above)																																																								
Word	Description																																																								
0,1	The minimum of the mark for the X axis; 32-bit integer number																																																								
2,3	The maximum of the mark for the X axis; 32-bit integer number																																																								
4,5	The minimum of the mark for the Y axis; 32-bit integer number																																																								
6,7	The maximum of the mark for the Y axis; 32-bit integer number																																																								
8,9	The minimum of X values for pen #1; 32-bit integer number, 32-bit unsigned integer number, or 32-bit floating point number																																																								
10,11	The maximum of X values for pen #1; (Same as above)																																																								
12,13	The minimum of Y values for pen #1; (Same as above)																																																								
14,15	The maximum of Y values for pen #1; (Same as above)																																																								
...	...																																																								
64,65	The minimum of X values for pen #8; (Same as above)																																																								
66,67	The maximum of X values for pen #8; (Same as above)																																																								
68,69	The minimum of Y values for pen #8; (Same as above)																																																								
70,71	The maximum of Y values for pen #8; (Same as above)																																																								



### 8.5.5. Pen Settings

This section describes how to define the pens for the scatter charts. The following is an example of the Pen page.

The following table describes each property in the Pen page. Note that pen #1 is for data set 1; pen #2 is for data set 2; and so on.

Property		Description
Pen #1 ~ Pen #8	Dynamic Range	Check this option so the minimum and the maximum for the X and Y values of the associated data set will be specified at runtime. This option is available when the Dynamic Range option in the General page is selected.
	X Min.	The X minimum of the associated data set. This property is available when the Dynamic Range option is not selected.
	X Max.	The X maximum of the data value of the associated data set. This property is available when the Dynamic Range option is not selected.
	Y Min.	The Y minimum of the associated data set. This property is available when the Dynamic Range option is not selected.
	Y Max.	The Y minimum of the associated data set. This property is available when the Dynamic Range option is not selected.
	Mark Size	Select a size for the data point mark. The selection is valid when the Show Mark option in the General page is selected.
	Line Style	Select a style for the connecting lines. The selection is valid when the Show Line option in the General page is selected.
	Color	Select a color for the connecting lines.

# CHAPTER 9

## ANIMATED OBJECTS

<b>9.1. Pipelines</b> .....	<b>1</b>
9.1.1. Basic Operations.....	1
9.1.2. Operation Options.....	1
9.1.3. Settings.....	1
9.1.4. General Settings.....	2
9.1.5. Pipe Settings.....	5
<b>9.2. Dynamic Circles</b> .....	<b>6</b>
9.2.1. Operation Options.....	6
9.2.2. Settings.....	6
9.2.3. General Settings.....	7
<b>9.3. Dynamic Rectangles</b> .....	<b>9</b>
9.3.1. Operation Options.....	9
9.3.2. Settings.....	9
9.3.3. General Settings.....	10
<b>9.4. GIF Displays</b> .....	<b>13</b>
9.4.1. Operation Options.....	13
9.4.2. Settings.....	13
9.4.3. General Settings.....	14
<b>9.5. Picture Displays</b> .....	<b>16</b>
9.5.1. Basic Operations.....	16
9.5.2. Operation Options.....	16
9.5.3. Settings.....	16
9.5.4. General Settings.....	17
<b>9.6. Animated Graphics</b> .....	<b>18</b>
9.6.1. Operation Options.....	18
9.6.2. Settings.....	18
9.6.3. General Settings.....	19
9.6.4. GIF Settings.....	22
9.6.5. Path Settings.....	23

## 9.1. Pipelines

### 9.1.1. Basic Operations

You can create a pipeline easily and efficiently. At runtime you can control a pipeline to change color, blink, and/or show the flow effect dynamically.

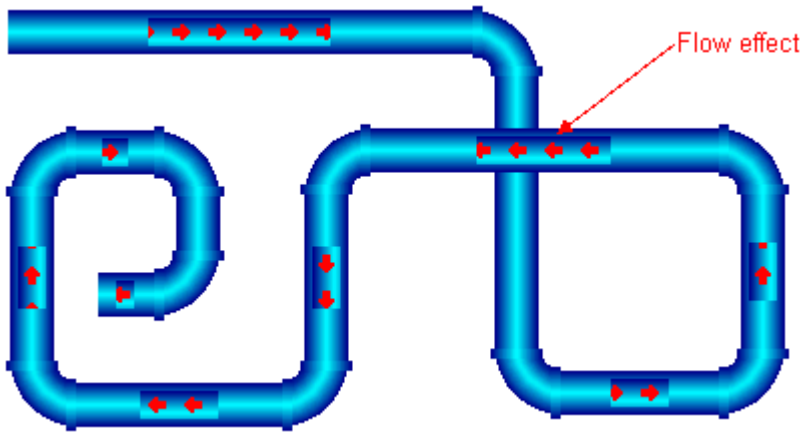

### 9.1.2. Operation Options

The following operation option can be added to a pipeline. Select and set up the option in the Pipeline property sheet.

Options	Description
Visibility Control	You can show and hide a pipeline by a specified bit or the current user level. Select and set up this option in the Visibility page.

### 9.1.3. Settings

You can complete all the settings of a pipeline in the Pipeline property sheet. This sheet contains the following three pages.

- **General**  
Described in [Section 9.1.4.](#)
- **Pipe**  
Described in [Section 9.1.5.](#)
- **Visibility**  
Described in [Section 4.3.4.](#)

### 9.1.4. General Settings

This section describes how to define the general settings for the pipelines. The following is an example of the General page of the Pipeline property sheet.

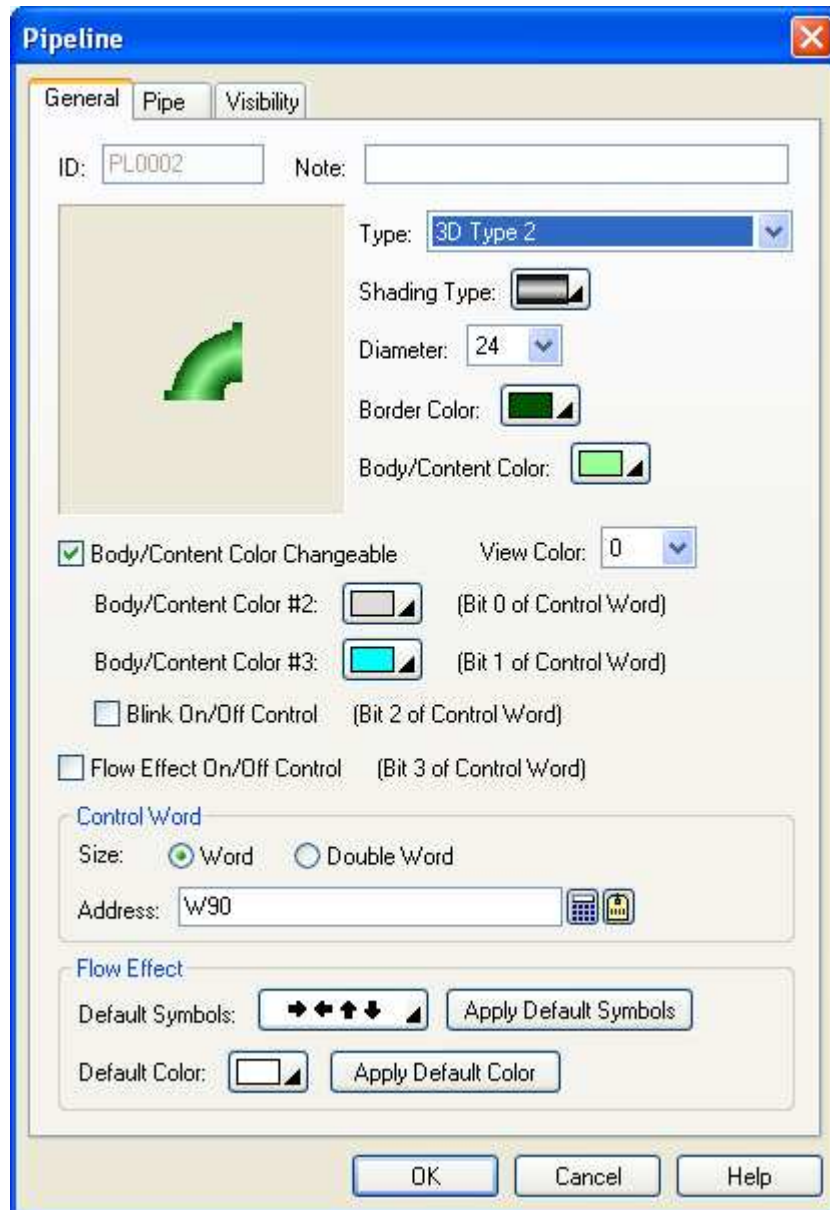

The following table describes each property in the General page.

Property	Description
ID	The object's identifier. It is generated when the object is created. The identifier is unique within the screen where the object is on. The format of the ID's for the pipelines is PLnnnn.
Note	You can type a note for the object.

Continued







Property		Description												
Type		<p>The type of the pipeline. There are five types available:</p> <table border="1"> <thead> <tr> <th>Type</th> <th>Example</th> </tr> </thead> <tbody> <tr> <td>2D Type 1</td> <td></td> </tr> <tr> <td>2D Type 2</td> <td></td> </tr> <tr> <td>2D Type 3</td> <td></td> </tr> <tr> <td>3D Type 1</td> <td></td> </tr> <tr> <td>3D Type 2</td> <td></td> </tr> </tbody> </table>	Type	Example	2D Type 1		2D Type 2		2D Type 3		3D Type 1		3D Type 2	
Type	Example													
2D Type 1														
2D Type 2														
2D Type 3														
3D Type 1														
3D Type 2														
Shading		<p>Select a shading method when the Type is "3D Type 1" or "3D Type 2". There are three shading methods available: </p>												
Diameter		Specifies the diameter of the pipeline.												
Border Color		Specifies the border color of the pipeline.												
Body/Content Color		Specifies the body or content color of the pipeline.												
Body/Content Color Changeable	<Check Box>	Check this option if you want to control the body/content color of the pipeline at runtime. The variable that controls the pipeline is called the control word and is specified in the Address field.												
	View Color	<p>Select a color so you can view the pipeline painted with that color.</p> <table border="1"> <thead> <tr> <th>View Color</th> <th>Painted With</th> </tr> </thead> <tbody> <tr> <td>0</td> <td>Body/Content Color</td> </tr> <tr> <td>1</td> <td>Body/Content Color #2</td> </tr> <tr> <td>2</td> <td>Body/Content Color #3</td> </tr> </tbody> </table>	View Color	Painted With	0	Body/Content Color	1	Body/Content Color #2	2	Body/Content Color #3				
	View Color	Painted With												
	0	Body/Content Color												
	1	Body/Content Color #2												
2	Body/Content Color #3													
Body/Content Color #2	Select a color as the second body/content color for the pipeline. This color will be used to paint the pipeline when bit 0 of the control word is on.													
Body/Content Color #3	Select a color as the third body/content color for the pipeline. This color will be used to paint the pipeline when bit 1 of the control word is on.													
Blink On/Off Control	Check this option if you want the pipeline to blink at runtime. The pipeline will blink when bit 2 of the control word is on.													

Continued



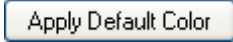

Property		Description									
Flow Effect On/Off Control		Check this option if you want to enable and disable the flow effect for the pipeline at runtime. The flow effect will be enabled when bit 3 of the control word is on.									
Control Word	Size	Select Word or Double Word for the size of the control word.									
	Address	<p>Specifies the variable that controls the pipeline.</p> <p>Click  to enter an address for this field. Click  to select a tag for this field.</p> <p>The following table shows the bit assignment data of the variable:</p> <table border="1"> <thead> <tr> <th>Bit</th> <th>Assignment</th> </tr> </thead> <tbody> <tr> <td>0</td> <td>Shows body/content color #2 when this bit is on</td> </tr> <tr> <td>1</td> <td>Shows body/content color #3 when this bit is on</td> </tr> <tr> <td>2</td> <td>Blinks when this bit is on</td> </tr> <tr> <td>3</td> <td>Shows the flow effect when this bit is on</td> </tr> </tbody> </table>	Bit	Assignment	0	Shows body/content color #2 when this bit is on	1	Shows body/content color #3 when this bit is on	2	Blinks when this bit is on	3
Bit	Assignment										
0	Shows body/content color #2 when this bit is on										
1	Shows body/content color #3 when this bit is on										
2	Blinks when this bit is on										
3	Shows the flow effect when this bit is on										
Flow Effect	Default Symbols	<p>Select a set of symbols as the default symbols for the flow effect. There are 12 available sets:</p>  <p>Click  to make all pipes of the pipeline use the default symbols for the follow effect.</p>									
	Default Color	<p>Select a color as the default color for the flow symbols.</p> <p>Click  to make all pipes of the pipeline use the default color for the follow symbols.</p>									

### 9.1.5. Pipe Settings

This section describes how to define the pipes for the pipelines. The following is an example of the Pipe page.

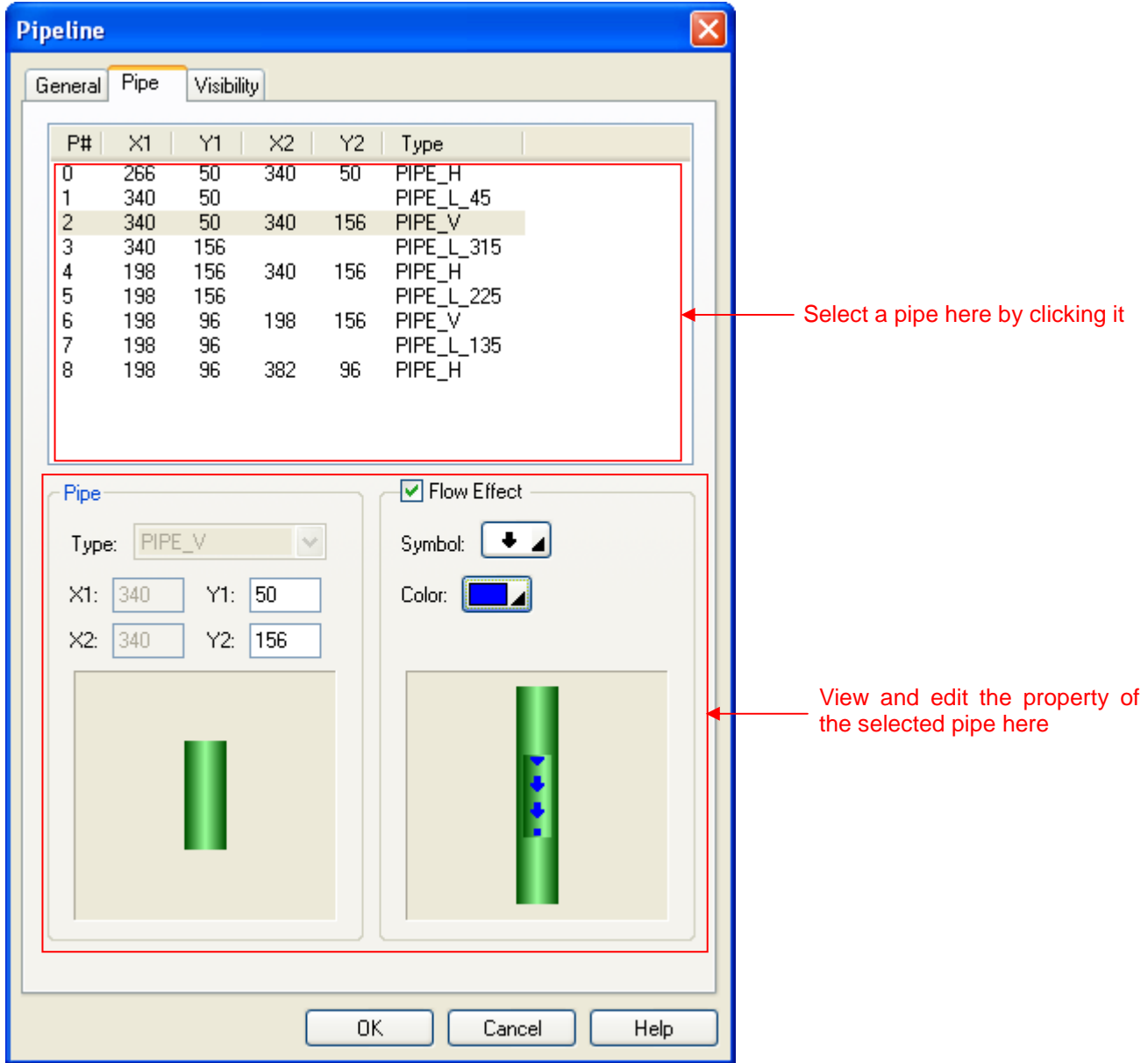

The following table describes each property in the Pipe page.

Property		Description
Pipe	Type	Specifies the type of the selected pipe.
	X1	The horizontal coordinate of the upper-left corner of the selected pipe.
	Y1	The vertical coordinate of the upper-left corner of the selected pipe.
	X2	The horizontal coordinate of the lower-right corner of the selected pipe.
	Y2	The vertical coordinate of the lower-right corner of the selected pipe.
Flow Effect	<Check Box>	Select this option if you want the selected pipe to show the flow effect.
	Symbol	Select a symbol for the flow effect.
	Color	Select a color for the flow symbol



## 9.2. Dynamic Circles

You can change the size, position, and/or color of a dynamic circle at runtime.

### 9.2.1. Operation Options

The following operation option can be added to a dynamic circle. Select and set up the option in the Dynamic Circle property sheet.

Options	Description
Visibility Control	You can show and hide a dynamic circle by a specified bit or the current user level. Select and set up this option in the Visibility page.

### 9.2.2. Settings

You can complete all the settings of a dynamic circle in the Dynamic Circle property sheet. This sheet contains the following two pages.

- **General**

Described in [Section 9.2.3.](#)

- **Visibility**

Described in [Section 4.3.4.](#)

### 9.2.3. General Settings

This section describes how to define the general settings for the dynamic circles. The following is an example of the General page of the Dynamic Circle property sheet.

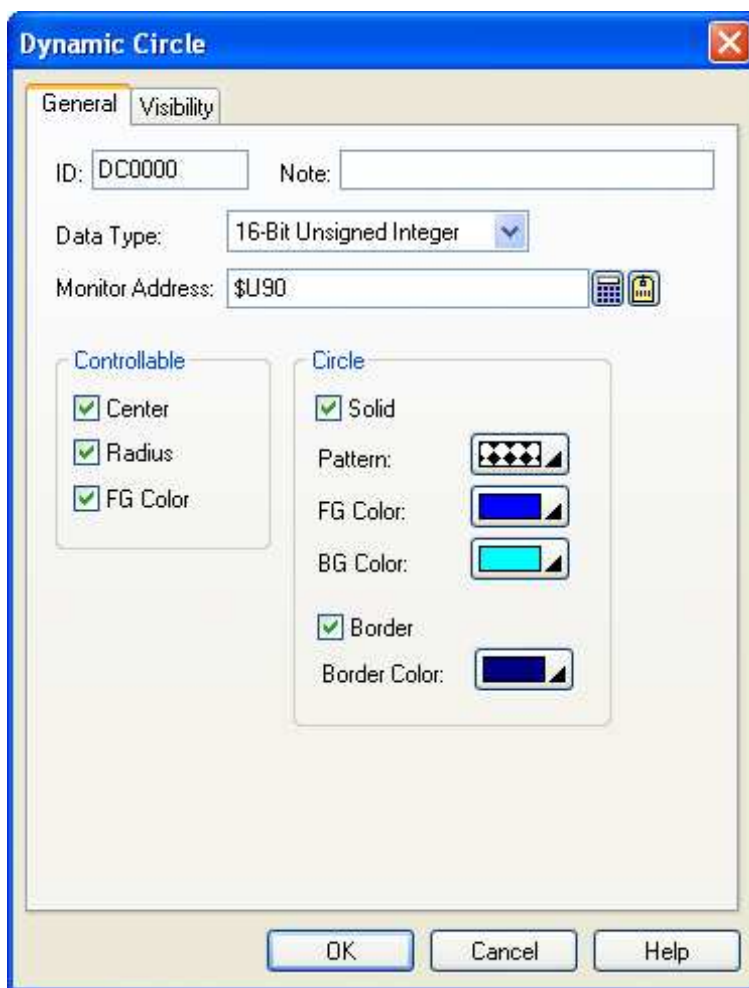

The following table describes each property in the General page.

Property	Description
ID	The object's identifier. It is generated when the object is created. The identifier is unique within the screen where the object is on. The format of the ID's for the dynamic circles is DCnnnn.
Note	You can type a note for the object.
Data Type	The data type of the variable that controls the dynamic circle. The supported data types include: 16-Bit Unsigned Integer, 32-Bit Unsigned Integer, 16-Bit Signed Integer, 32-Bit Signed Integer, 16-Bit BCD, and 32-Bit BCD.

Continued



Property		Description																									
Monitor Address		<p>Specifies the variable that controls the dynamic circle.</p> <p>Click  to enter an address for this field. Click  to select a tag for this field. The following table shows the data arrangement of the variable.</p> <table border="1"> <thead> <tr> <th>Data Type</th> <th>16-Bit Unsigned Int. 16-Bit Signed Int. 16-Bit BCD</th> <th>32-Bit Unsigned Int. 32-Bit Signed Int. 32-Bit BCD</th> </tr> </thead> <tbody> <tr> <td><input type="checkbox"/> Center <input type="checkbox"/> Radius <input checked="" type="checkbox"/> FG Color</td> <td>W0 <input type="text" value="FG Color"/></td> <td>W0,1 <input type="text" value="FG Color"/></td> </tr> <tr> <td><input type="checkbox"/> Center <input checked="" type="checkbox"/> Radius <input type="checkbox"/> FG Color</td> <td>W0 <input type="text" value="Radius"/></td> <td>W0,1 <input type="text" value="Radius"/></td> </tr> <tr> <td><input type="checkbox"/> Center <input checked="" type="checkbox"/> Radius <input checked="" type="checkbox"/> FG Color</td> <td>W0 <input type="text" value="Radius"/> W1 <input type="text" value="FG Color"/></td> <td>W0,1 <input type="text" value="Radius"/> W2,3 <input type="text" value="FG Color"/></td> </tr> <tr> <td><input checked="" type="checkbox"/> Center <input type="checkbox"/> Radius <input type="checkbox"/> FG Color</td> <td>W0 <input type="text" value="X"/> W1 <input type="text" value="Y"/></td> <td>W0,1 <input type="text" value="X"/> W2,3 <input type="text" value="Y"/></td> </tr> <tr> <td><input checked="" type="checkbox"/> Center <input type="checkbox"/> Radius <input checked="" type="checkbox"/> FG Color</td> <td>W0 <input type="text" value="X"/> W1 <input type="text" value="Y"/> W2 <input type="text" value="FG Color"/></td> <td>W0,1 <input type="text" value="X"/> W2,3 <input type="text" value="Y"/> W4,5 <input type="text" value="FG Color"/></td> </tr> <tr> <td><input checked="" type="checkbox"/> Center <input checked="" type="checkbox"/> Radius <input type="checkbox"/> FG Color</td> <td>W0 <input type="text" value="X"/> W1 <input type="text" value="Y"/> W2 <input type="text" value="Radius"/></td> <td>W0,1 <input type="text" value="X"/> W2,3 <input type="text" value="Y"/> W4,5 <input type="text" value="Radius"/></td> </tr> <tr> <td><input checked="" type="checkbox"/> Center <input checked="" type="checkbox"/> Radius <input checked="" type="checkbox"/> FG Color</td> <td>W0 <input type="text" value="X"/> W1 <input type="text" value="Y"/> W2 <input type="text" value="Radius"/> W3 <input type="text" value="FG Color"/></td> <td>W0,1 <input type="text" value="X"/> W2,3 <input type="text" value="Y"/> W4,5 <input type="text" value="Radius"/> W6,7 <input type="text" value="FG Color"/></td> </tr> </tbody> </table> <p><b>Note:</b> About the color values, see ?, ?.</p>		Data Type	16-Bit Unsigned Int. 16-Bit Signed Int. 16-Bit BCD	32-Bit Unsigned Int. 32-Bit Signed Int. 32-Bit BCD	<input type="checkbox"/> Center <input type="checkbox"/> Radius <input checked="" type="checkbox"/> FG Color	W0 <input type="text" value="FG Color"/>	W0,1 <input type="text" value="FG Color"/>	<input type="checkbox"/> Center <input checked="" type="checkbox"/> Radius <input type="checkbox"/> FG Color	W0 <input type="text" value="Radius"/>	W0,1 <input type="text" value="Radius"/>	<input type="checkbox"/> Center <input checked="" type="checkbox"/> Radius <input checked="" type="checkbox"/> FG Color	W0 <input type="text" value="Radius"/> W1 <input type="text" value="FG Color"/>	W0,1 <input type="text" value="Radius"/> W2,3 <input type="text" value="FG Color"/>	<input checked="" type="checkbox"/> Center <input type="checkbox"/> Radius <input type="checkbox"/> FG Color	W0 <input type="text" value="X"/> W1 <input type="text" value="Y"/>	W0,1 <input type="text" value="X"/> W2,3 <input type="text" value="Y"/>	<input checked="" type="checkbox"/> Center <input type="checkbox"/> Radius <input checked="" type="checkbox"/> FG Color	W0 <input type="text" value="X"/> W1 <input type="text" value="Y"/> W2 <input type="text" value="FG Color"/>	W0,1 <input type="text" value="X"/> W2,3 <input type="text" value="Y"/> W4,5 <input type="text" value="FG Color"/>	<input checked="" type="checkbox"/> Center <input checked="" type="checkbox"/> Radius <input type="checkbox"/> FG Color	W0 <input type="text" value="X"/> W1 <input type="text" value="Y"/> W2 <input type="text" value="Radius"/>	W0,1 <input type="text" value="X"/> W2,3 <input type="text" value="Y"/> W4,5 <input type="text" value="Radius"/>	<input checked="" type="checkbox"/> Center <input checked="" type="checkbox"/> Radius <input checked="" type="checkbox"/> FG Color	W0 <input type="text" value="X"/> W1 <input type="text" value="Y"/> W2 <input type="text" value="Radius"/> W3 <input type="text" value="FG Color"/>	W0,1 <input type="text" value="X"/> W2,3 <input type="text" value="Y"/> W4,5 <input type="text" value="Radius"/> W6,7 <input type="text" value="FG Color"/>
Data Type	16-Bit Unsigned Int. 16-Bit Signed Int. 16-Bit BCD	32-Bit Unsigned Int. 32-Bit Signed Int. 32-Bit BCD																									
<input type="checkbox"/> Center <input type="checkbox"/> Radius <input checked="" type="checkbox"/> FG Color	W0 <input type="text" value="FG Color"/>	W0,1 <input type="text" value="FG Color"/>																									
<input type="checkbox"/> Center <input checked="" type="checkbox"/> Radius <input type="checkbox"/> FG Color	W0 <input type="text" value="Radius"/>	W0,1 <input type="text" value="Radius"/>																									
<input type="checkbox"/> Center <input checked="" type="checkbox"/> Radius <input checked="" type="checkbox"/> FG Color	W0 <input type="text" value="Radius"/> W1 <input type="text" value="FG Color"/>	W0,1 <input type="text" value="Radius"/> W2,3 <input type="text" value="FG Color"/>																									
<input checked="" type="checkbox"/> Center <input type="checkbox"/> Radius <input type="checkbox"/> FG Color	W0 <input type="text" value="X"/> W1 <input type="text" value="Y"/>	W0,1 <input type="text" value="X"/> W2,3 <input type="text" value="Y"/>																									
<input checked="" type="checkbox"/> Center <input type="checkbox"/> Radius <input checked="" type="checkbox"/> FG Color	W0 <input type="text" value="X"/> W1 <input type="text" value="Y"/> W2 <input type="text" value="FG Color"/>	W0,1 <input type="text" value="X"/> W2,3 <input type="text" value="Y"/> W4,5 <input type="text" value="FG Color"/>																									
<input checked="" type="checkbox"/> Center <input checked="" type="checkbox"/> Radius <input type="checkbox"/> FG Color	W0 <input type="text" value="X"/> W1 <input type="text" value="Y"/> W2 <input type="text" value="Radius"/>	W0,1 <input type="text" value="X"/> W2,3 <input type="text" value="Y"/> W4,5 <input type="text" value="Radius"/>																									
<input checked="" type="checkbox"/> Center <input checked="" type="checkbox"/> Radius <input checked="" type="checkbox"/> FG Color	W0 <input type="text" value="X"/> W1 <input type="text" value="Y"/> W2 <input type="text" value="Radius"/> W3 <input type="text" value="FG Color"/>	W0,1 <input type="text" value="X"/> W2,3 <input type="text" value="Y"/> W4,5 <input type="text" value="Radius"/> W6,7 <input type="text" value="FG Color"/>																									
Controllable	Center	Check this option when you want to control the center.																									
	Radius	Check this option when you want to control the radius.																									
	FG Color	Check this option when you want to control the FG color. This option is available when the Circle is Solid and the Pattern is not the solid white.																									
Circle	Solid	<Check Box>	Check this option if you want the dynamic circle to be filled with the selected pattern.																								
		Pattern	Select a pattern for filling the dynamic circle.																								
		FG Color	Select a color for painting the black part of the pattern. This item is available when the Pattern is not solid white.																								
		BG Color	Select a color for painting the white part of the pattern.																								
	Border	<Check Box>	Check this option if you want the dynamic circle to have a border.																								
	Border Color	The border color.																									



## 9.3. Dynamic Rectangles

You can change the size, position, and/or color of a dynamic rectangle at runtime.

### 9.3.1. Operation Options

The following operation option can be added to a dynamic rectangle. Select and set up the option in the Dynamic Rectangle property sheet.

Options	Description
Visibility Control	You can show and hide a dynamic rectangle by a specified bit or the current user level. Select and set up this option in the Visibility page.

### 9.3.2. Settings

You can complete all the settings of a dynamic rectangle in the Dynamic Rectangle property sheet. This sheet contains the following two pages.

- **General**

Described in [Section 9.3.3](#).

- **Visibility**

Described in [Section 4.3.4](#).

### 9.3.3. General Settings

This section describes how to define the general settings for the dynamic rectangles. The following is an example of the General page of the Dynamic Rectangle property sheet.

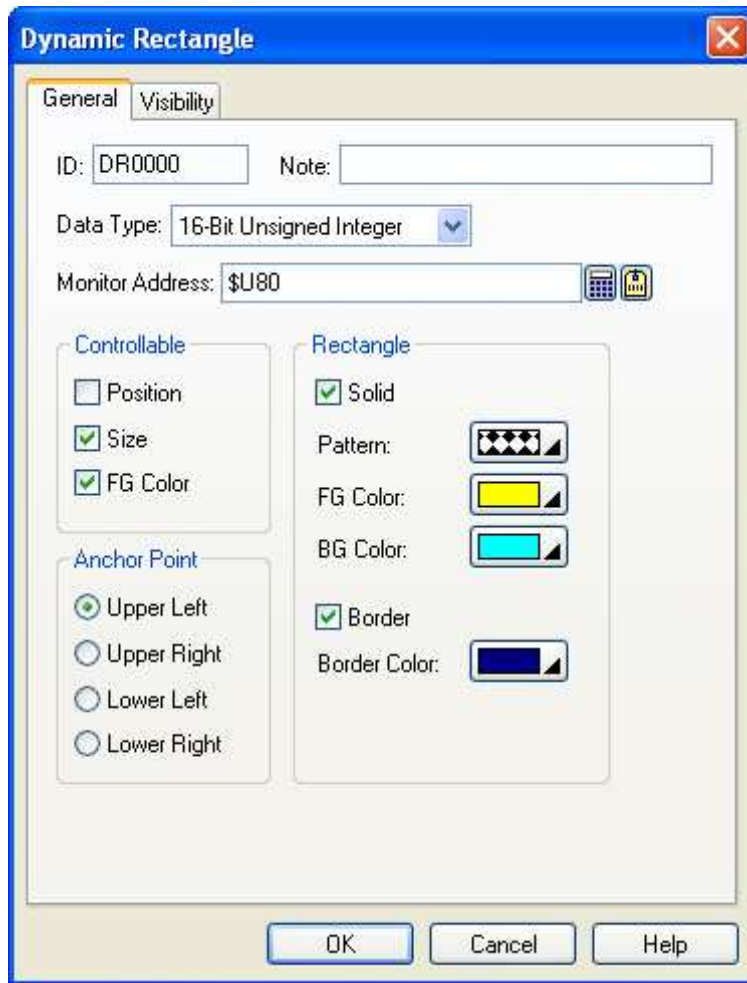

The following table describes each property in the General page.

Property	Description
ID	The object's identifier. It is generated when the object is created. The identifier is unique within the screen where the object is on. The format of the ID's for the dynamic rectangles is DRnnnn.
Note	You can type a note for the object.
Data Type	The data type of the variable that controls the dynamic rectangle. The supported data types include: 16-Bit Unsigned Integer, 32-Bit Unsigned Integer, 16-Bit Signed Integer, 32-Bit Signed Integer, 16-Bit BCD, and 32-Bit BCD.

Continued



Property		Description																								
Monitor Address		<p>Specifies the variable that controls the dynamic rectangle.</p> <p>Click  to enter an address for this field. Click  to select a tag for this field.</p> <p>The following table shows the data arrangement of the monitored variable.</p> <table border="1"> <thead> <tr> <th>Data Type</th> <th>16-Bit Unsigned Int. 16-Bit Signed Int. 16-Bit BCD</th> <th>32-Bit Unsigned Int. 32-Bit Signed Int. 32-Bit BCD</th> </tr> </thead> <tbody> <tr> <td> <input type="checkbox"/> Position  <input type="checkbox"/> Size  <input checked="" type="checkbox"/> FG Color                 </td> <td>W0 <input type="text" value="FG Color"/></td> <td>W0,1 <input type="text" value="FG Color"/></td> </tr> <tr> <td> <input type="checkbox"/> Position  <input checked="" type="checkbox"/> Size  <input type="checkbox"/> FG Color                 </td> <td>W0 <input type="text" value="Width"/> W1 <input type="text" value="Height"/></td> <td>W0,1 <input type="text" value="Width"/> W2,3 <input type="text" value="Height"/></td> </tr> <tr> <td> <input type="checkbox"/> Position  <input checked="" type="checkbox"/> Size  <input checked="" type="checkbox"/> FG Color                 </td> <td>W0 <input type="text" value="Width"/> W1 <input type="text" value="Height"/> W2 <input type="text" value="FG Color"/></td> <td>W0,1 <input type="text" value="Width"/> W2,3 <input type="text" value="Height"/> W4,5 <input type="text" value="FG Color"/></td> </tr> <tr> <td> <input checked="" type="checkbox"/> Position  <input type="checkbox"/> Size  <input type="checkbox"/> FG Color                 </td> <td>W0 <input type="text" value="X"/> W1 <input type="text" value="Y"/></td> <td>W0,1 <input type="text" value="X"/> W2,3 <input type="text" value="Y"/></td> </tr> <tr> <td> <input checked="" type="checkbox"/> Position  <input type="checkbox"/> Size  <input checked="" type="checkbox"/> FG Color                 </td> <td>W0 <input type="text" value="X"/> W1 <input type="text" value="Y"/> W2 <input type="text" value="FG Color"/></td> <td>W0,1 <input type="text" value="X"/> W2,3 <input type="text" value="Y"/> W4,5 <input type="text" value="FG Color"/></td> </tr> <tr> <td> <input checked="" type="checkbox"/> Position  <input checked="" type="checkbox"/> Size  <input type="checkbox"/> FG Color                 </td> <td>W0 <input type="text" value="X"/> W1 <input type="text" value="Y"/> W2 <input type="text" value="Width"/> W3 <input type="text" value="Height"/></td> <td>W0,1 <input type="text" value="X"/> W2,3 <input type="text" value="Y"/> W4,5 <input type="text" value="Width"/> W6,7 <input type="text" value="Height"/></td> </tr> <tr> <td> <input checked="" type="checkbox"/> Position  <input checked="" type="checkbox"/> Size  <input checked="" type="checkbox"/> FG Color                 </td> <td>W0 <input type="text" value="X"/> W1 <input type="text" value="Y"/> W2 <input type="text" value="Width"/> W3 <input type="text" value="Height"/> W4 <input type="text" value="FG Color"/></td> <td>W0,1 <input type="text" value="X"/> W2,3 <input type="text" value="Y"/> W4,5 <input type="text" value="Width"/> W6,7 <input type="text" value="Height"/> W8,9 <input type="text" value="FG Color"/></td> </tr> </tbody> </table> <p><b>Note:</b> About the color values, see ?, ?.</p>	Data Type	16-Bit Unsigned Int. 16-Bit Signed Int. 16-Bit BCD	32-Bit Unsigned Int. 32-Bit Signed Int. 32-Bit BCD	<input type="checkbox"/> Position <input type="checkbox"/> Size <input checked="" type="checkbox"/> FG Color	W0 <input type="text" value="FG Color"/>	W0,1 <input type="text" value="FG Color"/>	<input type="checkbox"/> Position <input checked="" type="checkbox"/> Size <input type="checkbox"/> FG Color	W0 <input type="text" value="Width"/> W1 <input type="text" value="Height"/>	W0,1 <input type="text" value="Width"/> W2,3 <input type="text" value="Height"/>	<input type="checkbox"/> Position <input checked="" type="checkbox"/> Size <input checked="" type="checkbox"/> FG Color	W0 <input type="text" value="Width"/> W1 <input type="text" value="Height"/> W2 <input type="text" value="FG Color"/>	W0,1 <input type="text" value="Width"/> W2,3 <input type="text" value="Height"/> W4,5 <input type="text" value="FG Color"/>	<input checked="" type="checkbox"/> Position <input type="checkbox"/> Size <input type="checkbox"/> FG Color	W0 <input type="text" value="X"/> W1 <input type="text" value="Y"/>	W0,1 <input type="text" value="X"/> W2,3 <input type="text" value="Y"/>	<input checked="" type="checkbox"/> Position <input type="checkbox"/> Size <input checked="" type="checkbox"/> FG Color	W0 <input type="text" value="X"/> W1 <input type="text" value="Y"/> W2 <input type="text" value="FG Color"/>	W0,1 <input type="text" value="X"/> W2,3 <input type="text" value="Y"/> W4,5 <input type="text" value="FG Color"/>	<input checked="" type="checkbox"/> Position <input checked="" type="checkbox"/> Size <input type="checkbox"/> FG Color	W0 <input type="text" value="X"/> W1 <input type="text" value="Y"/> W2 <input type="text" value="Width"/> W3 <input type="text" value="Height"/>	W0,1 <input type="text" value="X"/> W2,3 <input type="text" value="Y"/> W4,5 <input type="text" value="Width"/> W6,7 <input type="text" value="Height"/>	<input checked="" type="checkbox"/> Position <input checked="" type="checkbox"/> Size <input checked="" type="checkbox"/> FG Color	W0 <input type="text" value="X"/> W1 <input type="text" value="Y"/> W2 <input type="text" value="Width"/> W3 <input type="text" value="Height"/> W4 <input type="text" value="FG Color"/>	W0,1 <input type="text" value="X"/> W2,3 <input type="text" value="Y"/> W4,5 <input type="text" value="Width"/> W6,7 <input type="text" value="Height"/> W8,9 <input type="text" value="FG Color"/>
Data Type	16-Bit Unsigned Int. 16-Bit Signed Int. 16-Bit BCD	32-Bit Unsigned Int. 32-Bit Signed Int. 32-Bit BCD																								
<input type="checkbox"/> Position <input type="checkbox"/> Size <input checked="" type="checkbox"/> FG Color	W0 <input type="text" value="FG Color"/>	W0,1 <input type="text" value="FG Color"/>																								
<input type="checkbox"/> Position <input checked="" type="checkbox"/> Size <input type="checkbox"/> FG Color	W0 <input type="text" value="Width"/> W1 <input type="text" value="Height"/>	W0,1 <input type="text" value="Width"/> W2,3 <input type="text" value="Height"/>																								
<input type="checkbox"/> Position <input checked="" type="checkbox"/> Size <input checked="" type="checkbox"/> FG Color	W0 <input type="text" value="Width"/> W1 <input type="text" value="Height"/> W2 <input type="text" value="FG Color"/>	W0,1 <input type="text" value="Width"/> W2,3 <input type="text" value="Height"/> W4,5 <input type="text" value="FG Color"/>																								
<input checked="" type="checkbox"/> Position <input type="checkbox"/> Size <input type="checkbox"/> FG Color	W0 <input type="text" value="X"/> W1 <input type="text" value="Y"/>	W0,1 <input type="text" value="X"/> W2,3 <input type="text" value="Y"/>																								
<input checked="" type="checkbox"/> Position <input type="checkbox"/> Size <input checked="" type="checkbox"/> FG Color	W0 <input type="text" value="X"/> W1 <input type="text" value="Y"/> W2 <input type="text" value="FG Color"/>	W0,1 <input type="text" value="X"/> W2,3 <input type="text" value="Y"/> W4,5 <input type="text" value="FG Color"/>																								
<input checked="" type="checkbox"/> Position <input checked="" type="checkbox"/> Size <input type="checkbox"/> FG Color	W0 <input type="text" value="X"/> W1 <input type="text" value="Y"/> W2 <input type="text" value="Width"/> W3 <input type="text" value="Height"/>	W0,1 <input type="text" value="X"/> W2,3 <input type="text" value="Y"/> W4,5 <input type="text" value="Width"/> W6,7 <input type="text" value="Height"/>																								
<input checked="" type="checkbox"/> Position <input checked="" type="checkbox"/> Size <input checked="" type="checkbox"/> FG Color	W0 <input type="text" value="X"/> W1 <input type="text" value="Y"/> W2 <input type="text" value="Width"/> W3 <input type="text" value="Height"/> W4 <input type="text" value="FG Color"/>	W0,1 <input type="text" value="X"/> W2,3 <input type="text" value="Y"/> W4,5 <input type="text" value="Width"/> W6,7 <input type="text" value="Height"/> W8,9 <input type="text" value="FG Color"/>																								
Controllable	Position	Check this option when you want to control the position.																								
	Size	Check this option when you want to control the size.																								
	FG Color	Check this option when you want to control the FG color. This option is available when the Rectangle is Solid and the Pattern is not the solid white.																								

Continued





Property			Description
Anchor Point			Select one of the following four corners of the dynamic rectangle that will not move when its size changes: Upper Left, Upper Right, Lower Left, and Lower Right. This item is available when the Size is controllable but the Position is not controllable.
Rectangle	Solid	Solid	Check this option if you want the dynamic rectangle to be filled with the selected pattern.
		Pattern	Select a pattern for filling the dynamic rectangle.
		FG Color	Select a color for painting the black part of the pattern. This item is available when the Pattern is not solid white.
		BG Color	Select a color for painting the white part of the pattern.
	Border	Border	Check this option if you want the dynamic rectangle to have a border.
		Border Color	The border color.



## 9.4. GIF Displays

You can use a GIF display to show a GIF image and control the animation of that image.

### 9.4.1. Operation Options

The following operation option can be added to a GIF display. Select and set up the option in the GIF Display property sheet.

Options	Description
Visibility Control	You can show or hide a GIF display by a specified bit or the current user level. Select and set up this option in the Visibility page.

### 9.4.2. Settings

You can complete all the settings of a GIF display in the GIF Display property sheet. This sheet contains the following two pages.

- **General**

Described in [Section 9.4.3.](#)

- **Visibility**

Described in [Section 4.3.4.](#)

### 9.4.3. General Settings

This section describes how to define the general settings for the GIF displays. The following is an example of the General page of the GIF Display property sheet.

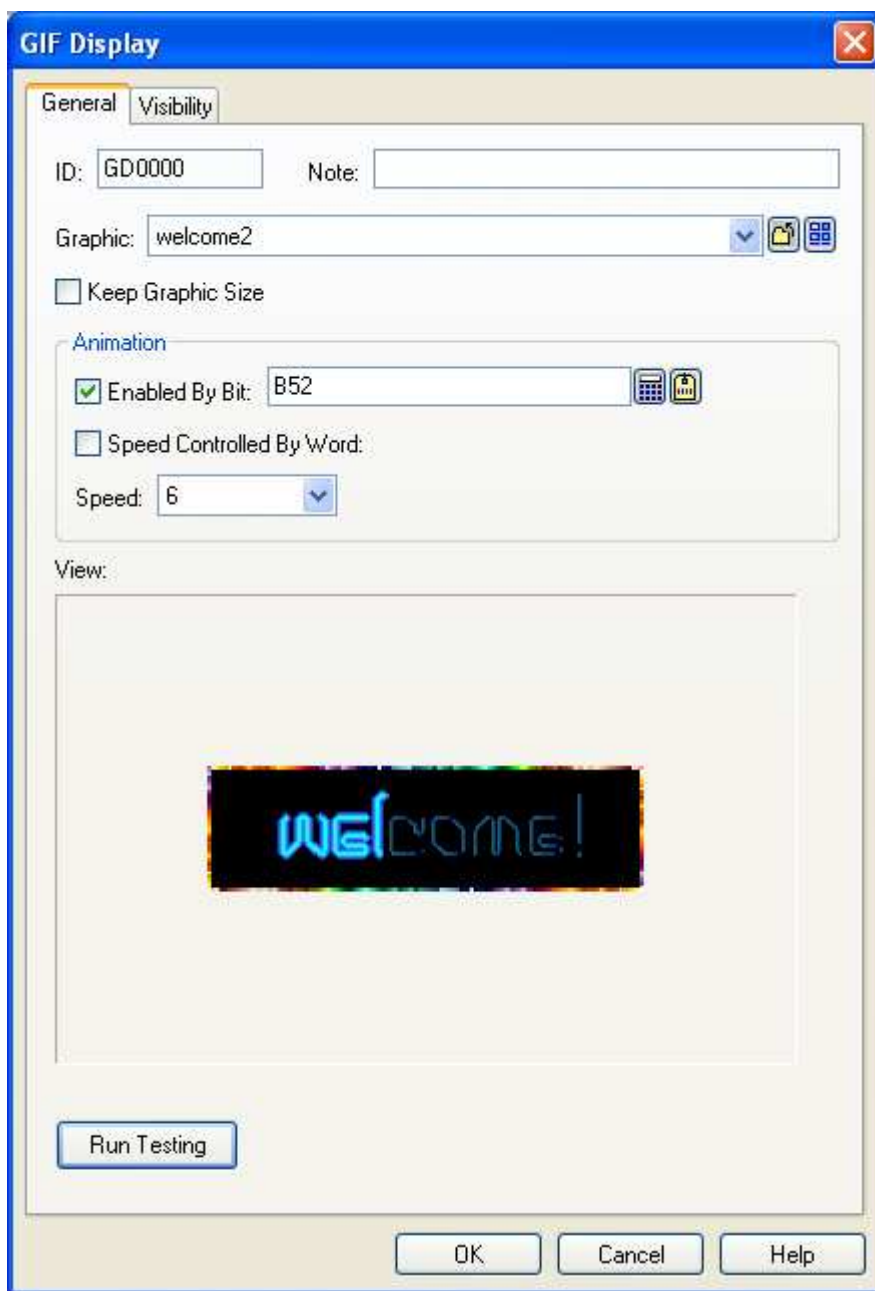





The following table describes each property in the General page.

Property	Description
ID	The object's identifier. It is generated when the object is created. The identifier is unique within the screen where the object is on. The format of the ID's for the GIF displays is GDnnnn.
Note	You can type a note for the object.
Graphic	Select a GIF image for the GIF display. You can use the drop-down list to select a GIF image from the picture database. You can click  to select a GIF image from a file. You can click  to select a GIF image from a library file. If the selected GIF image is not from the picture database, it is imported and saved in the picture database.

Continued

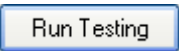

Property		Description
Keep Graphic Size		Check this option so the size of the selected graphic will not change with the object's size.
Animation	Enabled By Bit	Check this option so the animation will be enabled by the specified bit variable.
		Specifies the bit variable that enables the animation. Click  to enter an address for this field. Click  to select a tag for this field. The animation is enabled when the state of the variable is on.
	Speed Controlled By Word	Check this option so the speed of the animation will be controlled by the specified word variable.
Specifies the variable that controls the speed of the animation. Click  to enter an address for this field. Click  to select a tag for this field. The value of the variable can be from 0 to 10. The lowest speed is 1 and the highest speed is 10. The value 0 disables the animation.		
	Speed	Select a speed from 1 to 10 for the animation. The lowest speed is 1 and the highest speed is 10.
		Click this button to see the animation of the GIF display with the current settings on the screen.



## 9.5. Picture Displays

### 9.5.1. Basic Operations

You can use a variable to select and display a predefined picture with a picture display.

A picture display can have up to 256 states. Each state can have a predefined picture. The maximum number of states that a picture display can have is determined by the state type and the data type of the monitored variable. The following table shows the maximum in each case.

State Type	Type of Variable	Maximum
<b>Bit</b>	Bit	2
<b>Value</b>	16-bit	256
	32-bit	256
<b>LSB</b>	16-bit	17
	32-bit	33
<b>Animation</b>	Bit	256 <b>Note:</b> This is a special state type that is unique to the picture displays. The bit variable is used to control the animation. When the bit is on, the animation is enabled. When the bit is off, the animation is disabled. The animation is performed by showing the picture of each state one by one at a specified change frequency.

You need to specify the number of states for a picture display and the number must not exceed the allowable maximum. You can define a picture for each state. At runtime, a picture display shows the picture corresponding to the state of the monitored variable. The state of the monitored variable is determined by the state type and value of the variable.

### 9.5.2. Operation Options

The following operation option can be added to a picture display. Select and set up the option in the Picture Display property sheet.

Options	Description
Visibility Control	You can show or hide a picture display by a specified bit or the current user level. Select and set up this option in the Visibility page.

### 9.5.3. Settings

You can complete all the settings of a picture display in the Picture Display property sheet. This sheet contains the following three pages.

- **General**  
Described in [Section 9.5.4.](#)
- **Picture**  
Described in [Section 4.3.1.7.](#)
- **Visibility**  
Described in [Section 4.3.4.](#)



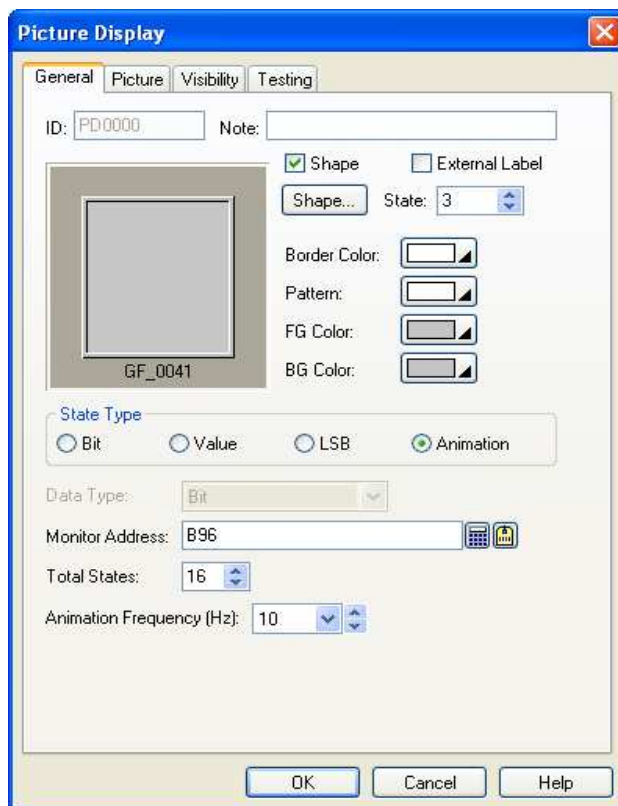

### 9.5.4. General Settings

This section describes how to define the general settings for the picture displays. The following is an example of the General page of the Picture Display property sheet.



The following table describes each property in the General page.

Property		Description
ID		The object's identifier. It is generated when the object is created. The identifier is unique within the screen where the object is on. The format of the ID's for the picture displays is PDnnnn.
Note		You can type a note for the object.
Shape	Shape	Check this option if you want the picture display to have a frame.
	Shape settings	For details about the following properties, see <a href="#">Section 4.3.1.4 Setting up the Shape of an Object</a> .  , Border Color, Pattern, FG Color, BG Color
External Label		Check this option if you want the picture display to have an external label. Set up the external label in the External Label page.
State		Select a state as the current state of the picture display so you can view and set the Pattern, FG Color, BG Color for that state.
State Type		The state type of the variable that controls the picture display. There are four state types you can select from: Bit, Value, LSB, and Bit For Enabling Animation. For details, see <a href="#">Section 9.5.1 Basic Operations</a> .
Data Type		The data type of the variable that controls the picture display. The supported data types include: Bit, 16-bit Unsigned Integer, 16-bit BCD, 32-bit Unsigned Integer, and 32-bit BCD.
Monitor Address		Specifies the variable that controls the picture display. Click  to enter an address for this field. Click  to select a tag for this field.
Total State		The number of states for the picture display.
Animation Frequency (Hz)		The rate to change the picture.



## 9.6. Animated Graphics

An animated graphic can change its image and move along a specified path automatically. You can also change the position and image of an animated graphic at runtime by a specified variable.( BMP/JPG/GIF/Object group supported ).

### 9.6.1. Operation Options

The following operation option can be added to an animated graphic. Select and set up the option in the Animated Graphic property sheet.

Options	Description
Visibility Control	You can show or hide an animated graphic by a specified bit or the current user level. Select and set up this option in the Visibility page.

### 9.6.2. Settings

You can complete all the settings of an animated graphic in the Animated Graphic property sheet. This sheet contains the following five pages. Some of the pages appear only when they are needed.

- **General**

Described in [Section 9.3.3.](#)

- **Picture**

Described in [Section 4.3.1.7.](#)

- **GIF**

Described in [Section 9.3.4.](#)

- **Path**

Described in [Section 9.3.5.](#)

- **Visibility**

Described in [Section 4.3.4.](#)

### 9.6.3. General Settings

This section describes how to define the general settings for the animated graphics. The following is an example of the General page of the Animated Graphic property sheet.

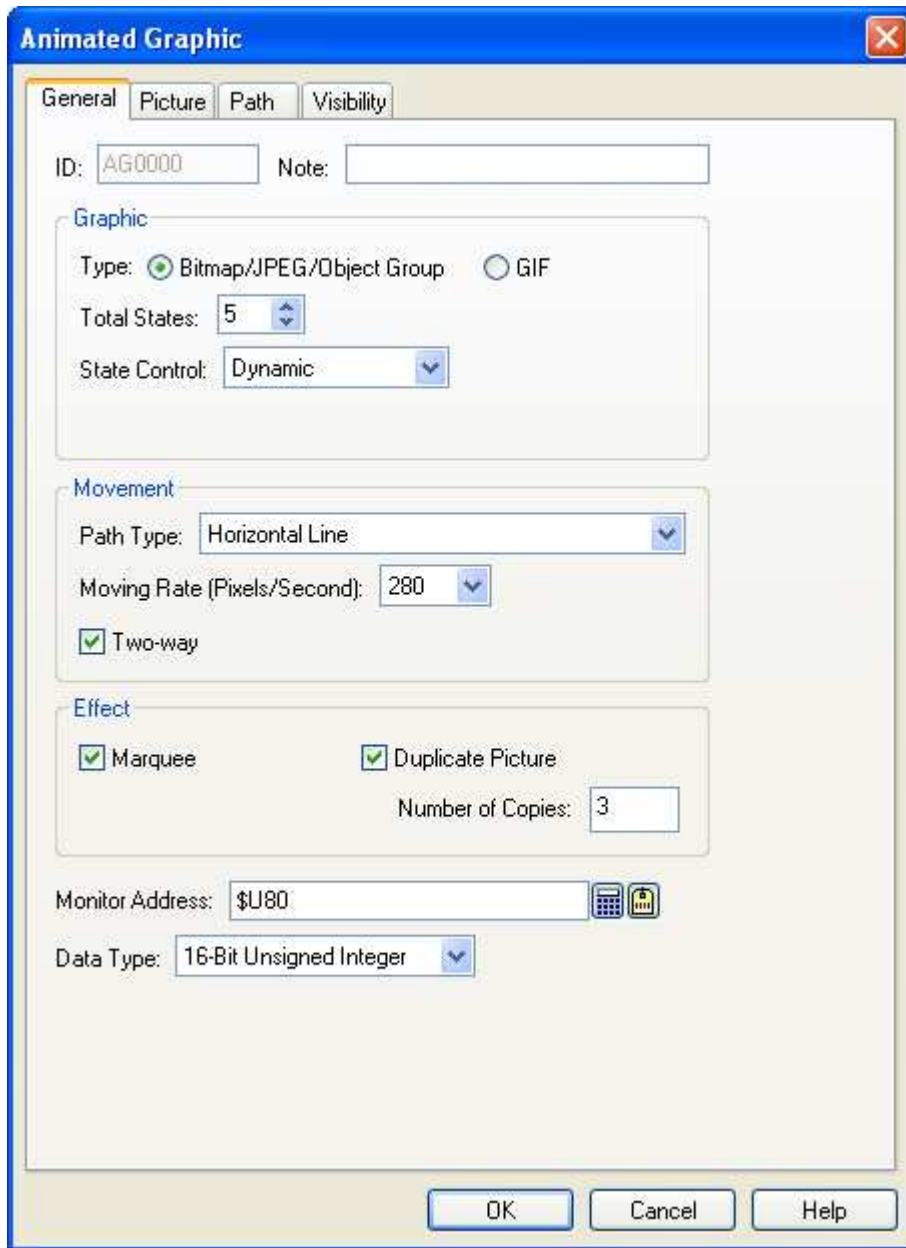

The following table describes each property in the General page.

Property	Description
ID	The object's identifier. It is generated when the object is created. The identifier is unique within the screen where the object is on. The format of the ID's for the animated graphics is AGnnnn.
Note	You can type a note for the object.

Continued





Property		Description														
Graphic	Type	<p>Select one of the following graphic types for the animated graphic:</p> <table border="1"> <thead> <tr> <th>Type</th> <th>Description</th> </tr> </thead> <tbody> <tr> <td>Bitmap/JPEG/Object Group</td> <td>You can configure the animated graphic to have up to 256 pictures. The pictures can be bitmap images, JPEG images, or object groups. Define the pictures in the Picture page. For details, see ?, ?.</td> </tr> <tr> <td>GIF</td> <td>The animated graphic can have one GIF image. Define the GIF image in the GIF page. The speed of the animation for the GIF image is specified in the Change Rate field.</td> </tr> </tbody> </table>	Type	Description	Bitmap/JPEG/Object Group	You can configure the animated graphic to have up to 256 pictures. The pictures can be bitmap images, JPEG images, or object groups. Define the pictures in the Picture page. For details, see ?, ?.	GIF	The animated graphic can have one GIF image. Define the GIF image in the GIF page. The speed of the animation for the GIF image is specified in the Change Rate field.								
	Type	Description														
	Bitmap/JPEG/Object Group	You can configure the animated graphic to have up to 256 pictures. The pictures can be bitmap images, JPEG images, or object groups. Define the pictures in the Picture page. For details, see ?, ?.														
	GIF	The animated graphic can have one GIF image. Define the GIF image in the GIF page. The speed of the animation for the GIF image is specified in the Change Rate field.														
Total States	The number of graphic states. You can specify a picture for each state. The animated graphic displays the associated picture for the current state.															
State Control	<p>Select one of the following methods to control the state of the animated graphic.</p> <table border="1"> <thead> <tr> <th>State Control</th> <th>Description</th> </tr> </thead> <tbody> <tr> <td>Automatic</td> <td>The animated graphic changes the state in sequence starting from state 0 at a rate specified in the Change Rate field. When the current state is the last state, it will change back to state 0.</td> </tr> <tr> <td>Position</td> <td>The state is determined by where the animated graphic is. In the Path page, you can define the associated state for each path point. For details, see ?, ?.</td> </tr> <tr> <td>Dynamic</td> <td>The state is determined at run time by the variable specified in the Monitor Address field.</td> </tr> </tbody> </table> <p>The animated graphic displays the associated picture for the current state.</p>	State Control	Description	Automatic	The animated graphic changes the state in sequence starting from state 0 at a rate specified in the Change Rate field. When the current state is the last state, it will change back to state 0.	Position	The state is determined by where the animated graphic is. In the Path page, you can define the associated state for each path point. For details, see ?, ?.	Dynamic	The state is determined at run time by the variable specified in the Monitor Address field.							
State Control	Description															
Automatic	The animated graphic changes the state in sequence starting from state 0 at a rate specified in the Change Rate field. When the current state is the last state, it will change back to state 0.															
Position	The state is determined by where the animated graphic is. In the Path page, you can define the associated state for each path point. For details, see ?, ?.															
Dynamic	The state is determined at run time by the variable specified in the Monitor Address field.															
Change Rate (Hz)	Select a rate when the State Control is Automatic or the Graphic Type is GIF.															
Movement	Path Type	<p>Select one of the following path types for the animated graphic:</p> <table border="1"> <thead> <tr> <th>Path Type</th> <th>Description</th> </tr> </thead> <tbody> <tr> <td>Still</td> <td>The animated graphic does not move.</td> </tr> <tr> <td>Horizontal Line</td> <td>The animated graphic moves along with a horizontal line.</td> </tr> <tr> <td>Vertical Line</td> <td>The animated graphic moves along with a vertical line.</td> </tr> <tr> <td>Connected Lines</td> <td>The animated graphic moves along with a set of connected lines.</td> </tr> <tr> <td>Dynamic</td> <td>The position of the animated graphic is determined at runtime by the variable specified in the Monitor Address field. The data elements of the variable that specify the position are X and Y. They specify the coordinate of the position.</td> </tr> <tr> <td>Dynamic; Predefined Positions</td> <td>The position of the animated graphic is determined at runtime by the variable specified in the Monitor Address field. The data element of the variable that specifies the position is Point. It specifies which point of the predefined path that the animated graphic should move to.</td> </tr> </tbody> </table>	Path Type	Description	Still	The animated graphic does not move.	Horizontal Line	The animated graphic moves along with a horizontal line.	Vertical Line	The animated graphic moves along with a vertical line.	Connected Lines	The animated graphic moves along with a set of connected lines.	Dynamic	The position of the animated graphic is determined at runtime by the variable specified in the Monitor Address field. The data elements of the variable that specify the position are X and Y. They specify the coordinate of the position.	Dynamic; Predefined Positions	The position of the animated graphic is determined at runtime by the variable specified in the Monitor Address field. The data element of the variable that specifies the position is Point. It specifies which point of the predefined path that the animated graphic should move to.
	Path Type	Description														
	Still	The animated graphic does not move.														
	Horizontal Line	The animated graphic moves along with a horizontal line.														
	Vertical Line	The animated graphic moves along with a vertical line.														
Connected Lines	The animated graphic moves along with a set of connected lines.															
Dynamic	The position of the animated graphic is determined at runtime by the variable specified in the Monitor Address field. The data elements of the variable that specify the position are X and Y. They specify the coordinate of the position.															
Dynamic; Predefined Positions	The position of the animated graphic is determined at runtime by the variable specified in the Monitor Address field. The data element of the variable that specifies the position is Point. It specifies which point of the predefined path that the animated graphic should move to.															
Moving Rate (Pixels/Second)	Select a moving rate for the animated graphic when the Path Type is Horizontal Line, Vertical Line, or Connected Lines.															
Two-way	Check this option so the animated graphic can go forth and back along the defined path. This option is available when the Path Type is Horizontal Line, Vertical Line, or Connected Lines.															

Continued



Property		Description																				
Effect	Marquee	Check this option if you want the current picture of the animated graphic to scroll into both ends of its path. This option is available when the Path Type is Horizontal Line or Vertical Line.																				
	Duplicate Picture	Check this option so the current picture of the animated graphic will be duplicated by a specified number of times. All the copies will display and move together. This option is available when the Marquee option is selected.																				
	Number of Copies	Specifies how many copies should be made for the Duplicate Picture option.																				
Monitor Address		<p>Specifies the variable that controls the animated graphic.</p> <p>Click  to enter an address for this field. Click  to select a tag for this field.</p> <p>The following table shows the data arrangement of the variable:</p> <table border="1"> <thead> <tr> <th rowspan="2">Settings</th> <th colspan="2">Data Type</th> </tr> <tr> <th>16-Bit Unsigned Int. 16-Bit Signed Int. 16-Bit BCD</th> <th>32-Bit Unsigned Int. 32-Bit Signed Int. 32-Bit BCD</th> </tr> </thead> <tbody> <tr> <td>State Control = Dynamic</td> <td>W0 <input type="text" value="State"/></td> <td>W0,1 <input type="text" value="State"/></td> </tr> <tr> <td>Path Type = Dynamic</td> <td>W0 <input type="text" value="X"/> W1 <input type="text" value="Y"/></td> <td>W0,1 <input type="text" value="X"/> W2,2 <input type="text" value="Y"/></td> </tr> <tr> <td>Path Type = Dynamic; Predefined Positions</td> <td>W0 <input type="text" value="Point"/></td> <td>W0,1 <input type="text" value="Point"/></td> </tr> <tr> <td>State Control = Dynamic Path Type = Dynamic</td> <td>W0 <input type="text" value="State"/> W1 <input type="text" value="X"/> W2 <input type="text" value="Y"/></td> <td>W0,1 <input type="text" value="State"/> W2,3 <input type="text" value="X"/> W4,5 <input type="text" value="Y"/></td> </tr> <tr> <td>State Control = Dynamic Path Type = Dynamic; Predefined Positions</td> <td>W0 <input type="text" value="State"/> W1 <input type="text" value="Point"/></td> <td>W0,1 <input type="text" value="State"/> W2,3 <input type="text" value="Point"/></td> </tr> </tbody> </table>	Settings	Data Type		16-Bit Unsigned Int. 16-Bit Signed Int. 16-Bit BCD	32-Bit Unsigned Int. 32-Bit Signed Int. 32-Bit BCD	State Control = Dynamic	W0 <input type="text" value="State"/>	W0,1 <input type="text" value="State"/>	Path Type = Dynamic	W0 <input type="text" value="X"/> W1 <input type="text" value="Y"/>	W0,1 <input type="text" value="X"/> W2,2 <input type="text" value="Y"/>	Path Type = Dynamic; Predefined Positions	W0 <input type="text" value="Point"/>	W0,1 <input type="text" value="Point"/>	State Control = Dynamic Path Type = Dynamic	W0 <input type="text" value="State"/> W1 <input type="text" value="X"/> W2 <input type="text" value="Y"/>	W0,1 <input type="text" value="State"/> W2,3 <input type="text" value="X"/> W4,5 <input type="text" value="Y"/>	State Control = Dynamic Path Type = Dynamic; Predefined Positions	W0 <input type="text" value="State"/> W1 <input type="text" value="Point"/>	W0,1 <input type="text" value="State"/> W2,3 <input type="text" value="Point"/>
Settings	Data Type																					
	16-Bit Unsigned Int. 16-Bit Signed Int. 16-Bit BCD	32-Bit Unsigned Int. 32-Bit Signed Int. 32-Bit BCD																				
State Control = Dynamic	W0 <input type="text" value="State"/>	W0,1 <input type="text" value="State"/>																				
Path Type = Dynamic	W0 <input type="text" value="X"/> W1 <input type="text" value="Y"/>	W0,1 <input type="text" value="X"/> W2,2 <input type="text" value="Y"/>																				
Path Type = Dynamic; Predefined Positions	W0 <input type="text" value="Point"/>	W0,1 <input type="text" value="Point"/>																				
State Control = Dynamic Path Type = Dynamic	W0 <input type="text" value="State"/> W1 <input type="text" value="X"/> W2 <input type="text" value="Y"/>	W0,1 <input type="text" value="State"/> W2,3 <input type="text" value="X"/> W4,5 <input type="text" value="Y"/>																				
State Control = Dynamic Path Type = Dynamic; Predefined Positions	W0 <input type="text" value="State"/> W1 <input type="text" value="Point"/>	W0,1 <input type="text" value="State"/> W2,3 <input type="text" value="Point"/>																				
Data Type		The data type of the variable that controls the animated graphic. The supported data types include: 16-bit Unsigned Integer, 32-bit Unsigned Integer, 16-bit Signed Integer, 32-bit Signed Integer, 16-bit BCD, and 32-bit BCD.																				

### 9.6.4. GIF Settings

This section describes how to define the GIF image for the animated graphics. The following is an example of the GIF page.

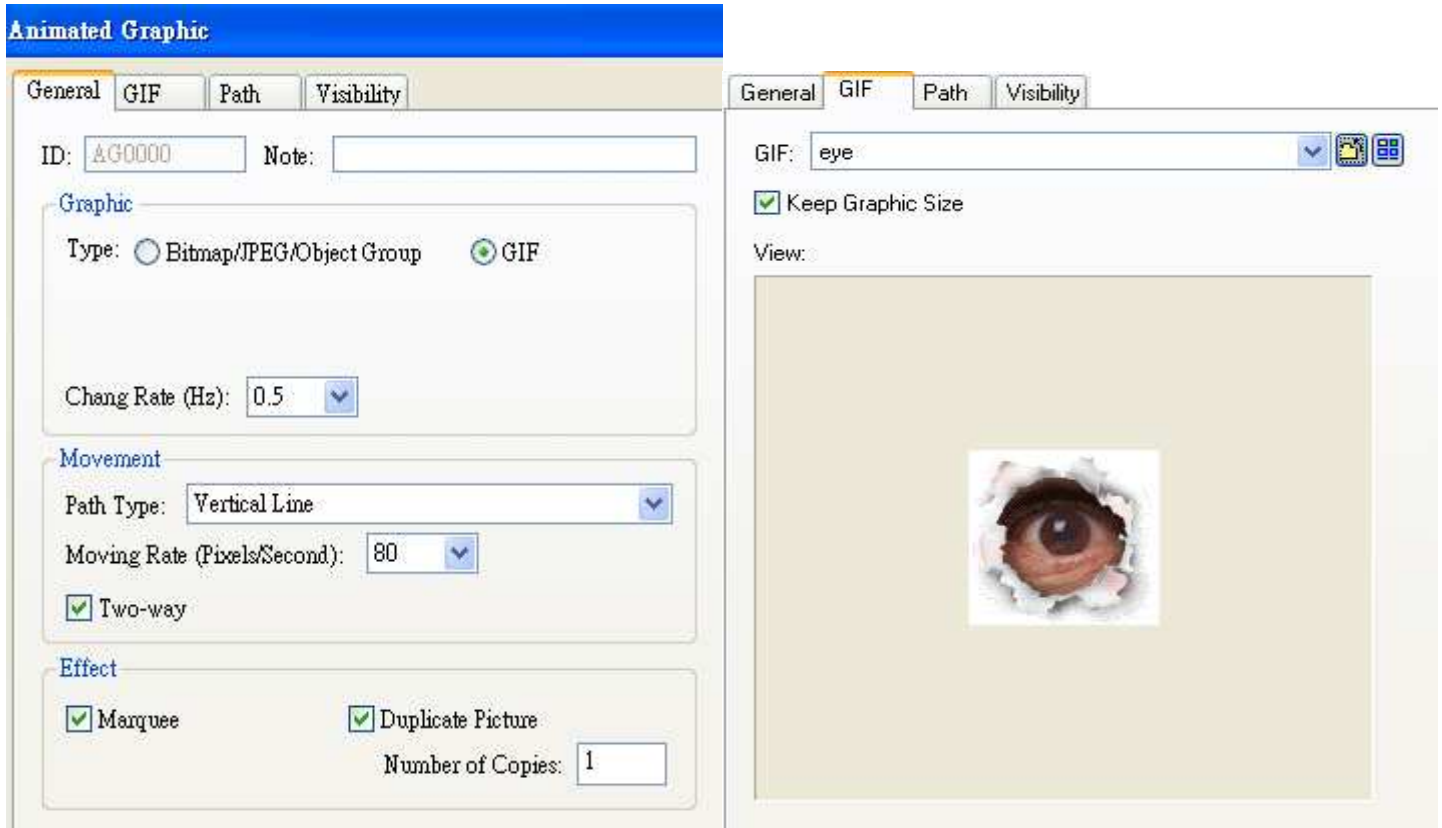

The following table describes each property in the GIF page.

Property	Description
GIF	Select a GIF image for the animated graphic. You can use the drop-down list to select a GIF image from the picture database. You can click  to select a GIF image from a file. You can click  to select a GIF image from a library file. If the selected GIF image is not from the picture database, it is imported and saved in the picture database.
Keep Graphic Size	Check this option so the size of the selected GIF image will not change with the object's size.

### 9.6.5. Path Settings

This section describes how to define the path settings for the animated graphics. You can define the path of an animated graphic in the editing window easily. To edit the path of an animated graphic, click it to display the path as shown in the following example.

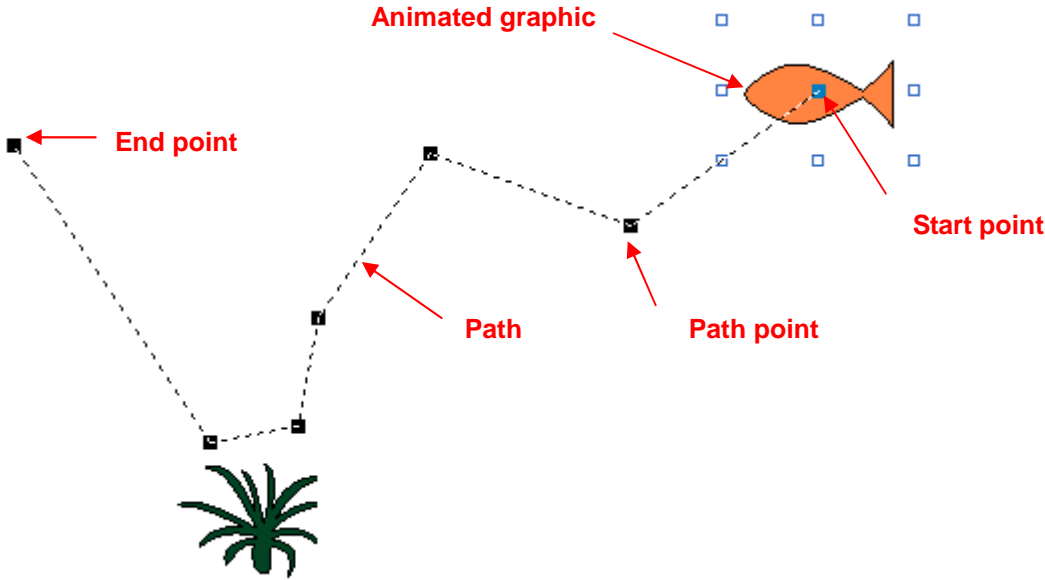

To modify the path, drag path points to desired positions. You can insert a path point by right-clicking at the desired position on the path and clicking Insert Point on the popped up menu. To delete a path point, right-click at the path point and click Delete Point on the popped up menu. Use the Path page to define all the properties of the path.

The following is an example of the Path page.

P#	X	Y	S#(F)	Pic(F)	S#(B)	Pic(B)
0	622	91	0	Fish		
1	528	158	0	Fish	1	Fish2
2	428	122	0	Fish	1	Fish2
3	372	204	0	Fish	1	Fish2
4	362	258	0	Fish	1	Fish2
5	318	266	0	Fish	1	Fish2
6	220	118			1	Fish2

Point

X:  Y:

Picture for Forward Movement

State:

Name:

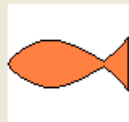

Picture for Backward Movement

State:

Name:

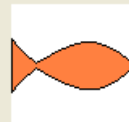



The following table describes each property in the Path page.

<b>Property</b>		<b>Description</b>
X		The horizontal coordinate of the selected path point.
Y		The vertical coordinate of the selected path point.
Picture for Forward Movement	State	The associated state of the selected path point for the forward movement.
	Name	The associated picture name of the selected state. It is also the associated picture name of the selected path point for the backward movement.
Picture for Backward Movement	State	The associated state of the selected path point for the backward movement.
	Name	The associated picture name of the selected state. It is also the associated picture name of the selected path point for the backward movement.



## CHAPTER 10

# RECIPES AND RECIPES OBJECTS

<b>10.1. Recipes .....</b>	<b>1</b>
<b>10.2. Recipe Data Flow and Memory Allocation .....</b>	<b>2</b>
<b>10.3. Working with Recipes .....</b>	<b>3</b>
<b>10.4. Transferring Recipes.....</b>	<b>4</b>
10.4.1. Between PC and MT (HMI).....	4
10.4.2. Between MT (HMI) and USB Memory Stick/Micro SD Card .....	4
10.4.3. Between battery backed memory and flash ROM.....	4
10.4.4. Between MT (HMI) and PLC/Controller .....	5
<b>10.5. Setting up Recipe Blocks .....</b>	<b>6</b>
10.5.1. General Settings.....	6
10.5.2. Data Item Settings .....	9
<b>10.6. Selecting a Recipe Using Recipe Selectors .....</b>	<b>11</b>
10.6.1. Basic Operations .....	11
10.6.2. Operation Options.....	12
10.6.3. Settings.....	12
10.6.4. General Settings.....	12
<b>10.7. Displaying and Modifying Recipe Data Using Recipe Tables.....</b>	<b>14</b>
10.7.1. Basic Operations .....	14
10.7.2. Operation Options.....	15
10.7.3. Settings.....	15
10.7.4. General Settings.....	15
10.7.5. Data Item Settings .....	17



In this chapter we will explain how recipes in PM Designer can be set up, stored and transferred. We also describe how to configure the basic functions and recipe objects (recipe selector and recipe table) used for recipes.

## 10.1. Recipes

### ■ Recipe Block

A recipe block is a memory block stored recipe data as a two dimensional array in the panel. The memory size of each recipe block is the product of the size of a recipe by number of recipes in word. You can create up to 16 recipe blocks for your application. Each recipe block can contain at most 65535 recipes. Each recipe can have as many as 4096 words of data.

### ■ Recipe

A recipe is a group of data items. You can use a recipe number or a recipe name to index a recipe in the corresponding recipe block.

The recipe number is a sequence number between 0 and number of recipes. It is unique among all recipes of the recipe block. The current recipe number of the recipe block m is saved in the current recipe number register \$RNM (m: The recipe block ID).

The recipe name can be represented by a specified ASCII or Unicode String data item of the recipe. To specify an ASCII or Unicode String data item as the recipe name, you need to open the dialog box of a recipe block and set the data type of the related data item into ASCII String or Unicode String in the data item page. For details about recipe data item settings, please see [Section 10.5.2](#).

### ■ Recipe Data Item

A data item is a word or words of data used to represent an application related data or a machine setup parameter used in process and production control. You can specify the format such as name, data type, size, scaling and range check for each data item in recipe block dialog box.

The following is a sample of a recipe block with 3 recipes and each recipe has 8 data items.

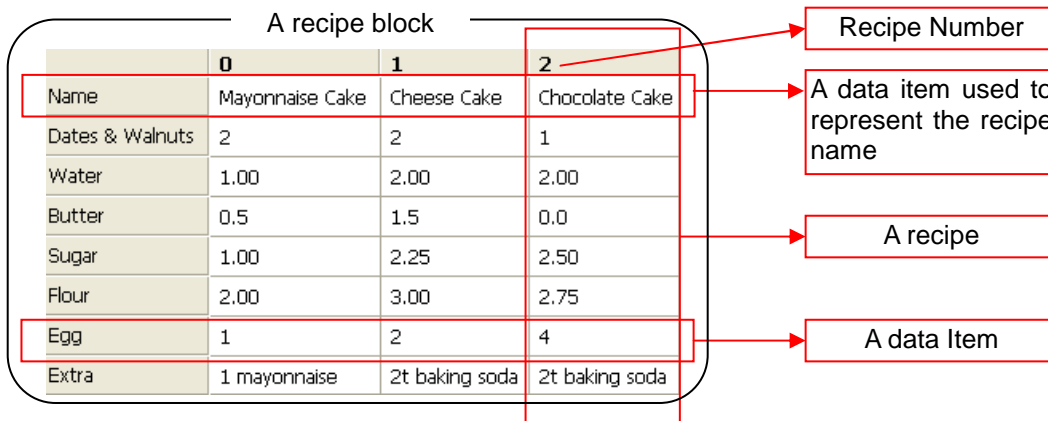

### ■ Recipe Data

There are two types of recipe data: TXT Data and PRD Data. These recipes can be transferred between PC and HMI or between HMI and USB Memory Stick/Micro SD card directly.

Recipe Data	Description
TXT Data	<ul style="list-style-type: none"> <li>Can be created and edited in Microsoft Excel or text editor software (e.g., Notepad)</li> </ul>
PRD Data	<ul style="list-style-type: none"> <li>Binary Data created in PM Designer</li> <li>Can be edited in RecipeEditor</li> </ul>



## 10.2. Recipe Data Flow and Memory Allocation

Assume there are two recipe blocks (Recipe Block 0 and Recipe Block 9) in an application. Recipe Block 0 has 3 recipes and each recipe has 4 data items named A,B,C and D. Recipe Block 9 has 2 recipes and each recipe has 3 data items named E,F and G.

The following illustration gives an overview of recipe data flow and recipe memory allocation.

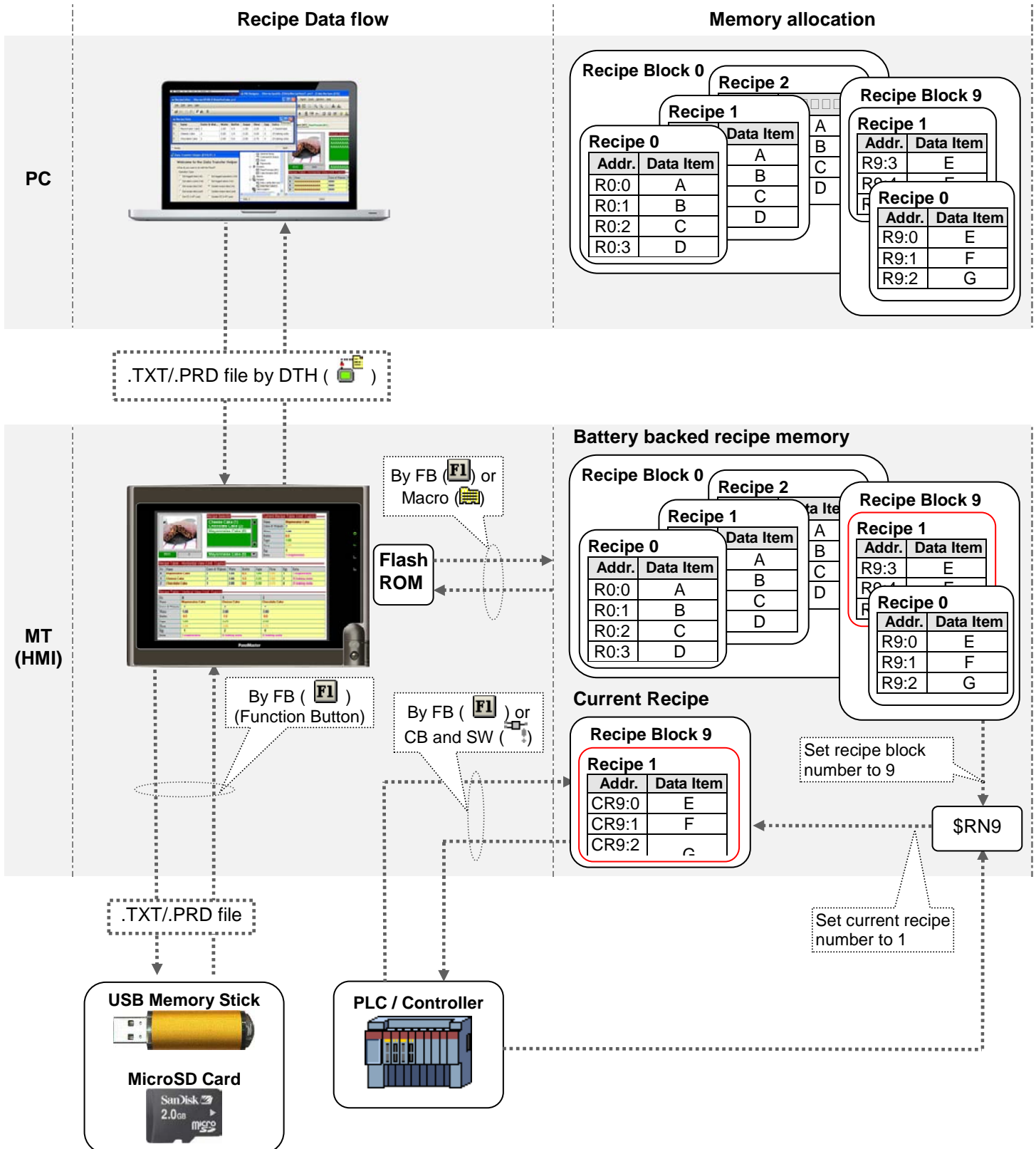



## 10.3. Working with Recipes

To work with recipes, you may need to do the followings:

### ■ Create and set up a recipe block

To create a recipe block, you may do one of the followings:

- 1) In the PM Designer's Project Manager tool window, right-click the Recipes node of the concerned panel application and select Add Recipe Block.
- 2) In the PM Designer's menu bar, click Panel to bring up the Panel sub-menu. Click Recipe Block in the Panel sub-menu to bring up the Recipe Block pop-up menu. Select Add in the pop-up menu.

For details about how to set up a recipe block, please see [Section 10.5](#).

### ■ View and edit recipe data on PC

On PC, you can use RecipeEditor to view and edit recipe data saved in \*.prd file. The following is an example of RecipeEditor.

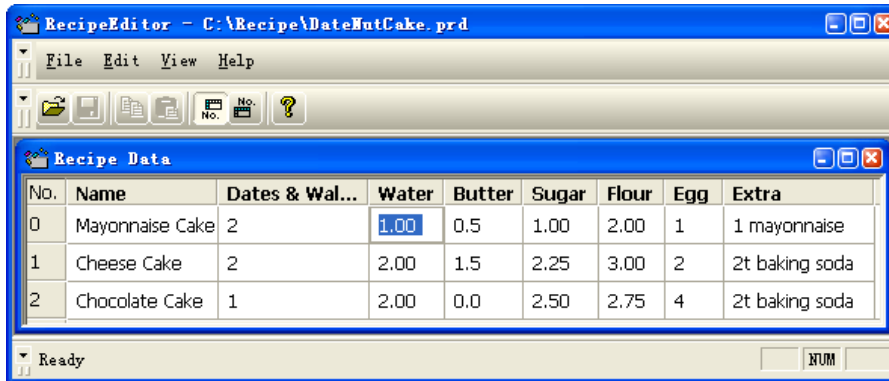

▶▶ To run the RecipeEditor, choose Start > Programs > PM Designer > RecipeEditor.

▶▶ To edit recipe data directly in the cell, right click the cell and key in the value you want. Note that any value unmatched the predefined format will cause an error when using the recipe at the runtime.

### ■ View and edit recipe data on MT (HMI)

On MT (HMI), you can use a recipe table to view and edit recipe data. For details about how to create and set up a recipe table for an application, please see [Section 10.7](#).

### ■ Select a recipe on MT (HMI)

On MT (HMI), you can select a recipe by using recipe selector. For details about how to create and set up a recipe selector for an application, please see [Section 10.6](#).

### ■ Transfer recipes

Described in [Section 10.4](#)

## 10.4. Transferring Recipes

### 10.4.1. Between PC and MT (HMI)

#### ■ By using Data Transfer Helper (DTH) ( )

You can use DTH to download recipe data in \*.prd/\*.txt file from PC to HMI. By DTH, you can also get recipe data from HMI and save the data in \*.prd/\*.txt file on PC. The following is an example of Data Transfer Helper (DTH) used to get or update recipe data.

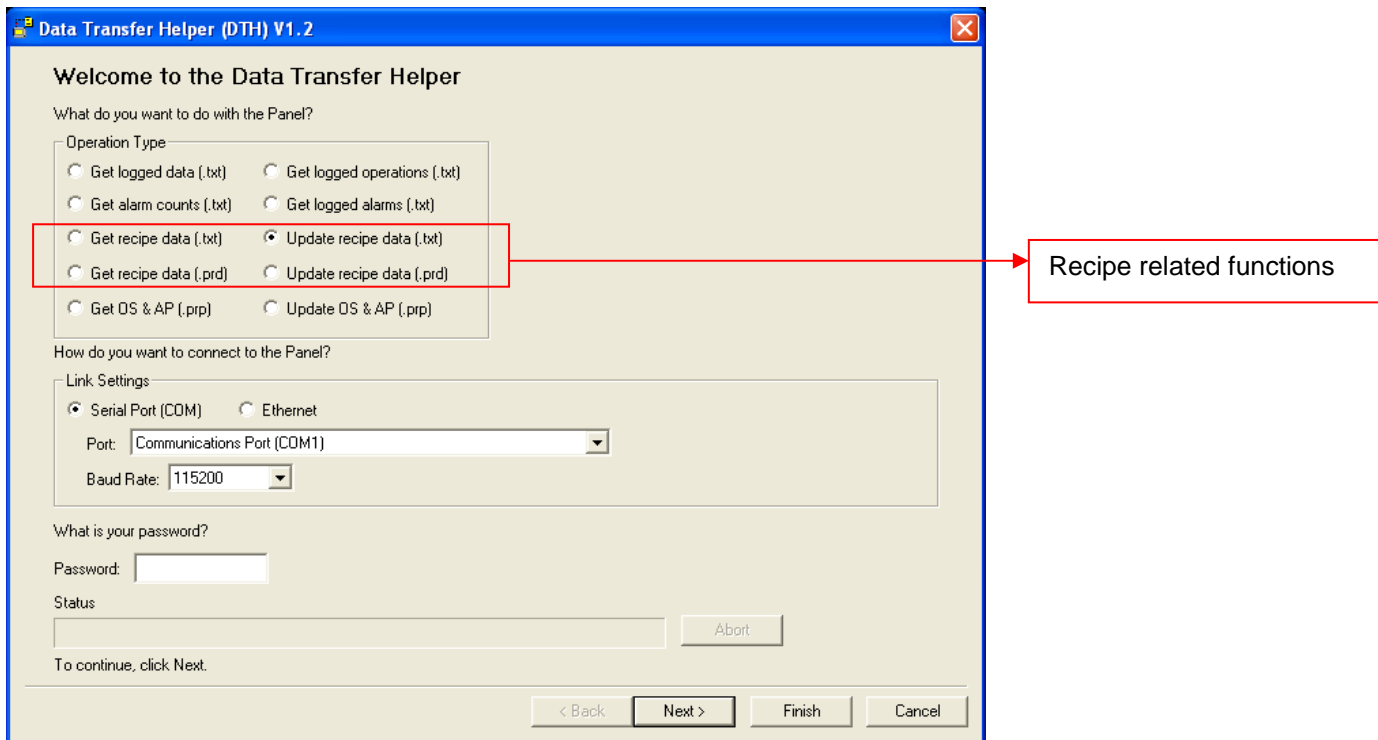

To run the DTH, choose Start > Programs > PM Designer > Data Transfer Helper (DTH).

### 10.4.2. Between MT (HMI) and USB Memory Stick/Micro SD Card

#### ■ By using Function Button ( )

You can use a function button to save recipe data of the specified recipe block in a .txt\prd file; load recipe data of the specified recipe block from a .txt\prd file. For details, please see [Section 5.4.1 Basic Operations](#) of function buttons

### 10.4.3. Between battery backed memory and flash ROM

#### ■ By using Macro Command ( )

You can use RB2ROM to save the data of the specified recipe block to flash ROM, and use ROM2RB to load recipe data from flash ROM. For details, please see [Section 5.4.1 Basic Operations](#) of Macro command

#### ■ By using Function Button ( )

You can use a function button to save recipe data to flash ROM, and load recipe data from flash ROM. For details, please see [Section 5.4.1 Basic Operations](#) of function buttons



#### 10.4.4. Between MT (HMI) and PLC/Controller

##### ■ By using Command Block and Status Words ( )

You can use command flag setting in Command Block to request the panel to set the current recipe number, read recipe from PLC or write recipe to PLC. You can also receive current recipe block ID or current recipe number by checking the related status word and specifying the word variable in Status Words. For details, please see [Section 3.5.1 Command Block and Status Words](#).

To change current recipe number, the PLC first sets the Parameter Two Register to the desired recipe block and the Parameter One Register to the desired recipe number, then turns on the Set Current Recipe Number (#2) command flag. Also \$RNm (Current Recipe Number Register, m: Recipe Block ID) of the panel can be changed by the PLC.

To update a recipe in the panel, the PLC first sets the Parameter Two Register to the desired recipe block and the Parameter One Register to the desired recipe number, then turns on the Read Recipe From PLC (#3) command flag. The panel reads data in Recipe Block to update the specified recipe in the panel.

To receive a recipe, the PLC first sets the Parameter Two Register to the desired recipe block and Parameter One Register to the desired recipe number, then turns on the Write Recipe To PLC (#4) command flag. The panel sends the specified recipe data to the Recipe Block in PLC.

**Note:** You do not need to specify the recipe block if the application has only one recipe block.

**Note:** To make the above operation work, the specified recipe block must exist, or the panel ignores the request. And the specified recipe number in the Parameter One Register must be between 0 and the maximum recipe number - 1. If the Parameter One Register is greater than or equal to the maximum recipe number, the panel ignores the request.

##### ■ By using Function Button ( )

You can use a function button to write the current recipe to controller, or update current recipe by reading the recipe from controller. For details, please see [Section 5.4.1 Basic Operations](#) of function buttons

## 10.5. Setting up Recipe Blocks

You can set up a recipe block with the Recipe Block dialog box. There are two ways to open the dialog box of a recipe block:

- 1) In the PM Designer's Project Manager window, right-click the node of the desired Recipe Block and select Properties.
- 2) In the PM Designer's menu bar, click Panel to bring up the Panel sub-menu. Click Recipes in the Panel sub-menu to bring up the Recipe Block pop-up menu. Select Properties in the pop-up menu to bring up the recipe block list of the current panel application. Select the recipe block in the list.

The Recipe Block dialog box contains the following two pages:

- **General**

Described in [Section 10.5.1](#).

- **Data Item**

Described in [Section 10.5.2](#).

### 10.5.1. General Settings

Use the General page to define the general settings for a recipe block. The following is an example of the General page.

**Recipe Block**

General | Data Item

Name:  ID:

Recipe Size:  words      Number Of Recipes:

Memory Required:  words

Write Recipe To PLC

Write Address:

Notification      Bit:

Read Recipe From PLC       Read Address Identical To Write Address

Read Address:

Notification      Bit:

Read/Write Size:  words

Reverse the order of the high word and low word of 32-bit data

Recipe Memory:

Bit Address Range:

Word Address Range:

Current Recipe:

Bit Address Range:

Word Address Range:

Current Recipe Number Register:

OK      Cancel      Help



The table below describes each property in the General page.

Property	Description									
Name	The recipe block's name. The maximum length of the name is 48 characters.									
ID	The recipe block's ID number. Select a number between 0 and 15. The number is unique among all recipe blocks of the panel application.									
Recipe Size	Specifies the data size that each recipe contains. The unit is word									
Number of Recipes	Specifies the maximum number of recipes that the recipe memory can hold.									
Memory Required	The size of the recipe memory. The unit is word. The formula to calculate the size is the size is: Memory Required = Recipe Size * Number of Recipes									
Write Recipe To PLC	Check the option if you want to write the recipe to PLC									
Write Address	Available when the Write Recipe To PLC is checked. Specifies the variable that is the starting address of the Recipe Block in your PLC. Click  to enter an address for this field. Click  to select a tag for this field. The size of the recipes to be written is specified in the Read/Write Size field.									
Notification	Check the option if you want the recipe to set the bit specified in the Bit Field to On when finishing writing recipe to PLC.									
Bit	Available when the Notification field is checked. Specifies the bit for the operation done notification. Click  to enter an address for this field. Click  to select a tag for this field.									
Read Recipe From PLC	Check this option if you want to read recipes from PLC.									
Read Address Identical To Write Address	Specifies that the Read Address is identical to the Write Address. With this item checked, you don't need to specify the Read Address again. This item is available when the option Read Recipe From PLC is checked.									
Read Address	Available when the Read Recipe From PLC is checked. Specifies the variable representing the starting address of the recipe block in your PLC. Click  to enter an address for this field. Click  to select a tag for this field. The size of the recipes to be read is specified in the Read/Write Size field.									
Notification	Check the option if you want the recipe to set the bit specified in the Bit Field to On when finishing reading recipe from PLC.									
Bit	Available when the Notification field is checked. Specifies the bit for the operation done notification. Click  to enter an address for this field. Click  to select a tag for this field.									
Read/Write Size	The size of recipe for reading and writing.									
Reverse the order of the high word and low word of 32-bit data	Check this option if the Write Address or the Read Address belongs to a controller that stores data in big-endian byte order and if there are 32-bit data items, such as 32-bit signed integers and 32-bit floating point numbers, defined in the recipe block.									
Recipe Memory	The address range of the internal memory in the panel that the overall recipe block locates. <table border="1" style="width: 100%; border-collapse: collapse;"> <thead> <tr> <th>Range Type</th> <th>Address Format</th> <th>Description</th> </tr> </thead> <tbody> <tr> <td>Bit Address Range</td> <td>\$Rm:n.b b: 0~f</td> <td>Each bit address in the range refers to a bit of a recipe word in specified recipe block.</td> </tr> <tr> <td>Word Address Range</td> <td>\$Rm:n</td> <td>Each word address in the range refers to a recipe word</td> </tr> </tbody> </table> <p><b>Legend:</b> m = Recipe Block ID; n = The Number of Recipe Word, b = Bit Number;</p>	Range Type	Address Format	Description	Bit Address Range	\$Rm:n.b b: 0~f	Each bit address in the range refers to a bit of a recipe word in specified recipe block.	Word Address Range	\$Rm:n	Each word address in the range refers to a recipe word
Range Type	Address Format	Description								
Bit Address Range	\$Rm:n.b b: 0~f	Each bit address in the range refers to a bit of a recipe word in specified recipe block.								
Word Address Range	\$Rm:n	Each word address in the range refers to a recipe word								

Continued



Property	Description		
Current Recipe	The address range of the internal memory in the panel that the current recipe locates.		
	Range Type	Address Format	Description
	Bit Address Range	\$CRm:n.b b: 0~f	Each bit address in the range refers to a bit of a recipe word in the current recipe of the specified recipe block.
	Word Address Range	\$CRm:n	Each word address in the range refers to a recipe word in the current recipe of the specified recipe block.
Current Recipe Number Register	\$RNm	An internal register of the panel that specifies the current recipe number of the specified recipe block.	
<b>Legend:</b> m = Recipe Block ID; n = The Number of Recipe Word, b = Bit Number;			
Need space in flash ROM to save backup	Check this option if you need the space in flash ROM to save the backup recipes.		
Do not use battery backed RAM	Check this option so the memory of the recipes will be located in ordinary RAM and the recipe memory will be cleared whenever the target panel is powered up. If this option is not selected, the memory of the recipes will be located in the battery backed RAM. The recipe data will not be lost after power down if the battery backed RAM is used for the recipes.		





### 10.5.2. Data Item Settings

Use the Data Item page to define the data items of the data for a recipe. The following is an example of the Data Item page.

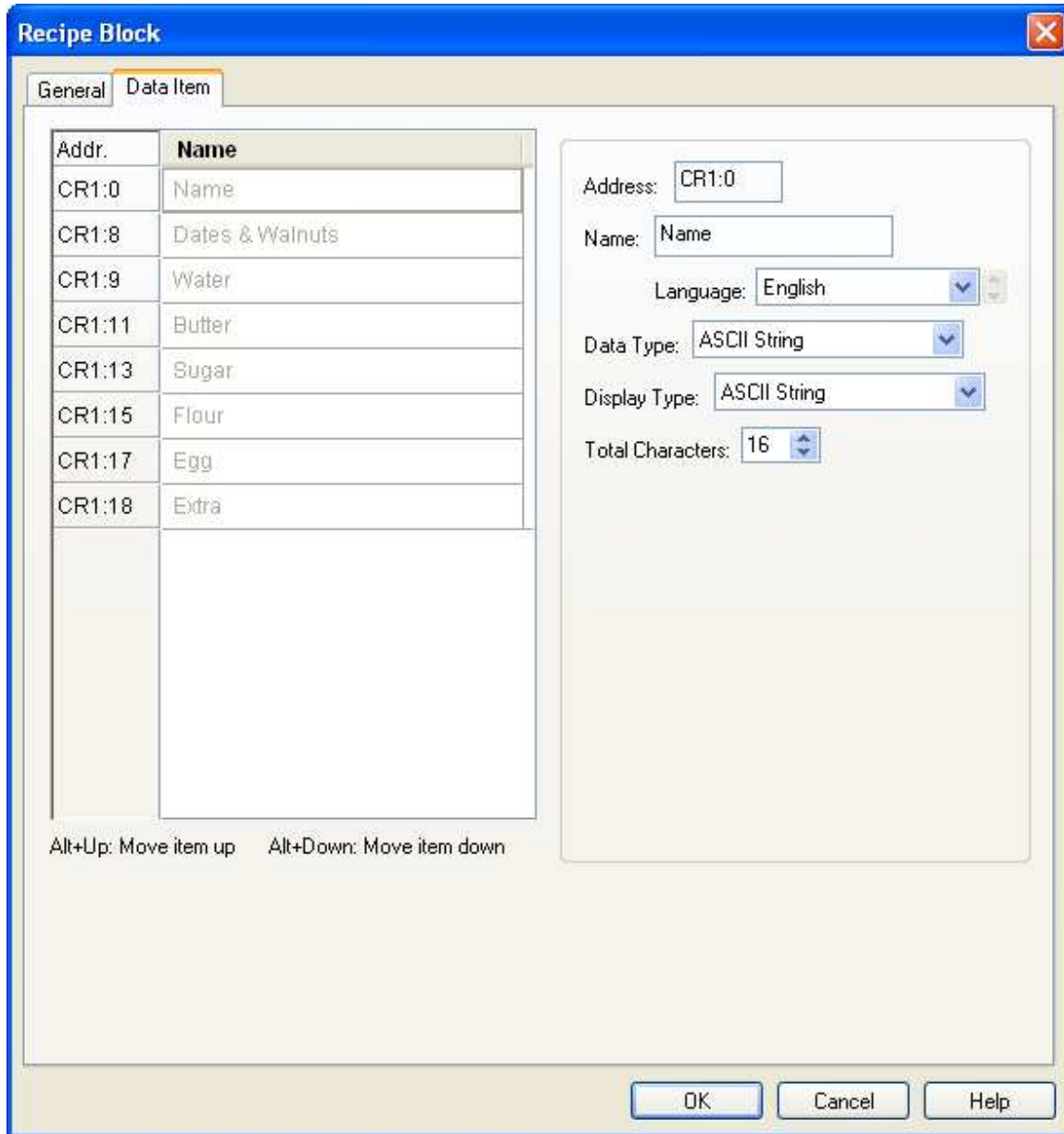

The Data Item page contains two parts. The left part is the data item list that shows the address and name of each data item in a row. The right part shows the properties of the selected data item. To select a data item, click the row of that data item in the data item list. The following table describes each property of the data item.

Property	Description
Address	You can use the address shown here to refer to the latest value of the data item.
Name	Specifies the name of the data item for the language specified in the Language field.
Language	Select a language so you can view and edit the name of the data item for that language.
Data Type	The data type of the data item. The supported data types include: 16-Bit Unsigned Integer, 32-Bit Unsigned Integer, 16-Bit Signed Integer, 32-Bit Signed Integer, 16-Bit BCD, 32-Bit BCD, 32-Bit Floating Point, ASCII String, and Unicode String. Note that Unicode String is supported for PM SCADA only.

Continued







Property	Description																									
Display Type	<p>The display type for the value of the data item. The following table shows the available display types for each data type.</p> <table border="1"> <thead> <tr> <th>Data Type</th> <th>Available Display Types</th> </tr> </thead> <tbody> <tr> <td>16-Bit Unsigned Integer</td> <td>16-Bit Unsigned Decimal, 16-Bit Hexadecimal, 16-Bit Octal</td> </tr> <tr> <td>32-Bit Unsigned Integer</td> <td>32-Bit Unsigned Decimal, 32-Bit Hexadecimal, 32-Bit Octal</td> </tr> <tr> <td>16-Bit Signed Integer</td> <td>16-Bit Signed Decimal</td> </tr> <tr> <td>32-Bit Signed Integer</td> <td>32-Bit Signed Decimal</td> </tr> <tr> <td>16-Bit BCD</td> <td>16-Bit Unsigned Decimal</td> </tr> <tr> <td>32-Bit BCD</td> <td>32-Bit Unsigned Decimal</td> </tr> <tr> <td>32-Bit Floating Point</td> <td>32-Bit Floating Point</td> </tr> <tr> <td>ASCII String</td> <td>ASCII String</td> </tr> <tr> <td>Unicode String</td> <td>Unicode String</td> </tr> </tbody> </table>	Data Type	Available Display Types	16-Bit Unsigned Integer	16-Bit Unsigned Decimal, 16-Bit Hexadecimal, 16-Bit Octal	32-Bit Unsigned Integer	32-Bit Unsigned Decimal, 32-Bit Hexadecimal, 32-Bit Octal	16-Bit Signed Integer	16-Bit Signed Decimal	32-Bit Signed Integer	32-Bit Signed Decimal	16-Bit BCD	16-Bit Unsigned Decimal	32-Bit BCD	32-Bit Unsigned Decimal	32-Bit Floating Point	32-Bit Floating Point	ASCII String	ASCII String	Unicode String	Unicode String					
Data Type	Available Display Types																									
16-Bit Unsigned Integer	16-Bit Unsigned Decimal, 16-Bit Hexadecimal, 16-Bit Octal																									
32-Bit Unsigned Integer	32-Bit Unsigned Decimal, 32-Bit Hexadecimal, 32-Bit Octal																									
16-Bit Signed Integer	16-Bit Signed Decimal																									
32-Bit Signed Integer	32-Bit Signed Decimal																									
16-Bit BCD	16-Bit Unsigned Decimal																									
32-Bit BCD	32-Bit Unsigned Decimal																									
32-Bit Floating Point	32-Bit Floating Point																									
ASCII String	ASCII String																									
Unicode String	Unicode String																									
Total Digits	Specifies the number of digits to be displayed for the value of the data item.																									
Fractional Digits	<p>Specifies how to display the fractional part for the value of the data item. When the Display Type is 32-bit Floating Point, this property specifies the number of fractional digits to be displayed. When the Display Type is not 32-bit Floating Point, this property specifies not only the number of fractional digits to be displayed but also the number of least significant digits to be displayed as the fractional part. With this feature, an integer can be shown as a fixed point number.</p> <p><b>Example:</b></p> <table border="1"> <thead> <tr> <th>Display Type</th> <th>Total Digits</th> <th>Fractional Digits</th> <th>Sampled Value</th> <th>Displayed Value</th> </tr> </thead> <tbody> <tr> <td>32-bit Floating Point</td> <td>4</td> <td>2</td> <td>12.34</td> <td>12.34</td> </tr> <tr> <td>32-bit Floating Point</td> <td>4</td> <td>2</td> <td>123.4</td> <td>23.40</td> </tr> <tr> <td>16-bit Signed Decimal</td> <td>5</td> <td>2</td> <td>12345</td> <td>123.45</td> </tr> <tr> <td>16-bit Signed Decimal</td> <td>5</td> <td>2</td> <td>-5</td> <td>-0.05</td> </tr> </tbody> </table>	Display Type	Total Digits	Fractional Digits	Sampled Value	Displayed Value	32-bit Floating Point	4	2	12.34	12.34	32-bit Floating Point	4	2	123.4	23.40	16-bit Signed Decimal	5	2	12345	123.45	16-bit Signed Decimal	5	2	-5	-0.05
Display Type	Total Digits	Fractional Digits	Sampled Value	Displayed Value																						
32-bit Floating Point	4	2	12.34	12.34																						
32-bit Floating Point	4	2	123.4	23.40																						
16-bit Signed Decimal	5	2	12345	123.45																						
16-bit Signed Decimal	5	2	-5	-0.05																						
Scaling	<p>Check this option if you want the value of the data item to be displayed in a scaled manner. The following is the scaling formula:</p> $\text{DisplayedValue} = \text{SampledValue} * \text{Gain} + \text{Offset}$ <p><b>Note:</b> The <i>Gain</i> and <i>Offset</i> are 32-bit floating point numbers. They have at most 6 significant digits. The rounding and truncation errors may happen.</p>																									
Gain	Available when the Scaling option is checked. Specifies the <i>Gain</i> used in the scaling formula.																									
Offset	Available when the Scaling option is checked. Specifies the <i>Offset</i> used in the scaling formula.																									
Range Check	Check this option if you want the data item to verify the entered value according to the specified minimum and maximum. If the entered value is not within the allowable range, the entered value will not be output.																									
Min	Specifies the minimum value.																									
Max	Specifies the maximum value.																									



## 10.6. Selecting a Recipe Using Recipe Selectors

### 10.6.1. Basic Operations

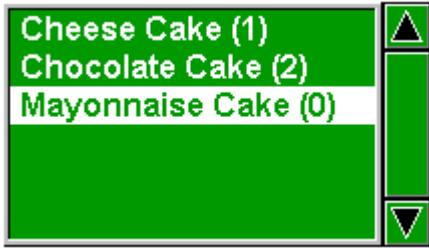
A recipe selector can be configured to perform as one of the following types of controls:

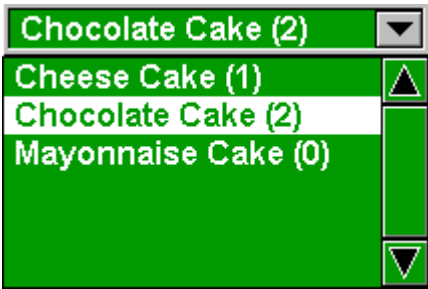
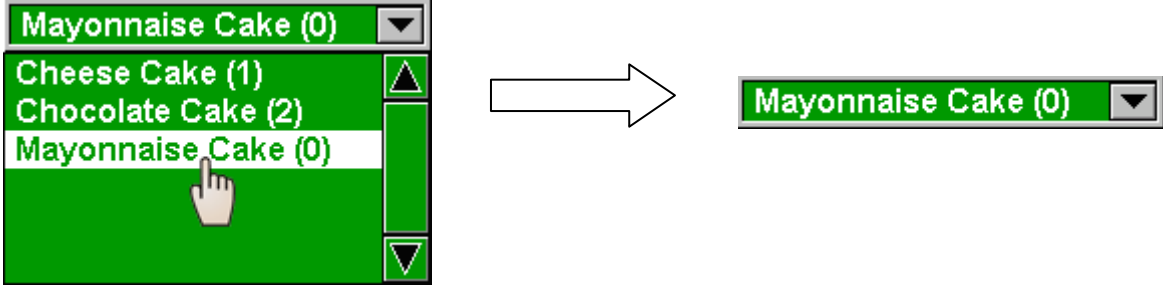
Type	Description	
List	<p>The recipe selector is a list box. It displays a list of index strings of the recipes in the specified recipe block. The index string's format is recipe name(recipe number). One recipe index string per line.</p> <p>The index string of the current recipe is highlighted. If the desired recipe is not in the view, you can scroll the list by the scroll bar attached to the right side of the list box. When you select a desired recipe by touching its index string, the recipe selector writes the recipe number of the selected recipe to current recipe number register.</p>	
Drop-down List	<p>The recipe selector is a drop-down list. It displays the index string of the current recipe and a button with the down arrow symbol as shown in the following example.</p> <p></p> <p>When the button is touched, the recipe selector displays a list box beneath itself as shown in the following example.</p> <p></p> <p>The list box lists the index strings of all recipes of the recipe block. One index string per line. The index string of the current recipe is highlighted. If the desired recipe is not in the view, you can use the scroll bar attached to the right side of the list to scroll the index string. When you select a desired recipe by touching its index string, the recipe selector writes the recipe number of the selected recipe to current recipe number register and closes the list box.</p> <p></p> <p>If you want to cancel the operation when the list box is showing, touch anywhere other than the index string in the list box.</p>	

## 10.6.2. Operation Options

The following operation option can be added to a recipe selector. Select and set up the option in the recipe selector property sheet.

Options	Description
Visibility Control	You can show or hide a recipe selector by a specified bit or the current user level. Select and set up this option in the Visibility page.

## 10.6.3. Settings

You can complete all the settings of a recipe selector in the Recipe Selector property sheet. This sheet contains the following three pages.

- **General**

Described in [Section 10.6.4.](#)

- **Advanced**

Described in [Section 4.4.5.](#)

- **Visibility**

Described in [Section 4.4.6.](#)

## 10.6.4. General Settings

This section describes how to define the general settings for a recipe selector. The following is an example of the General page.

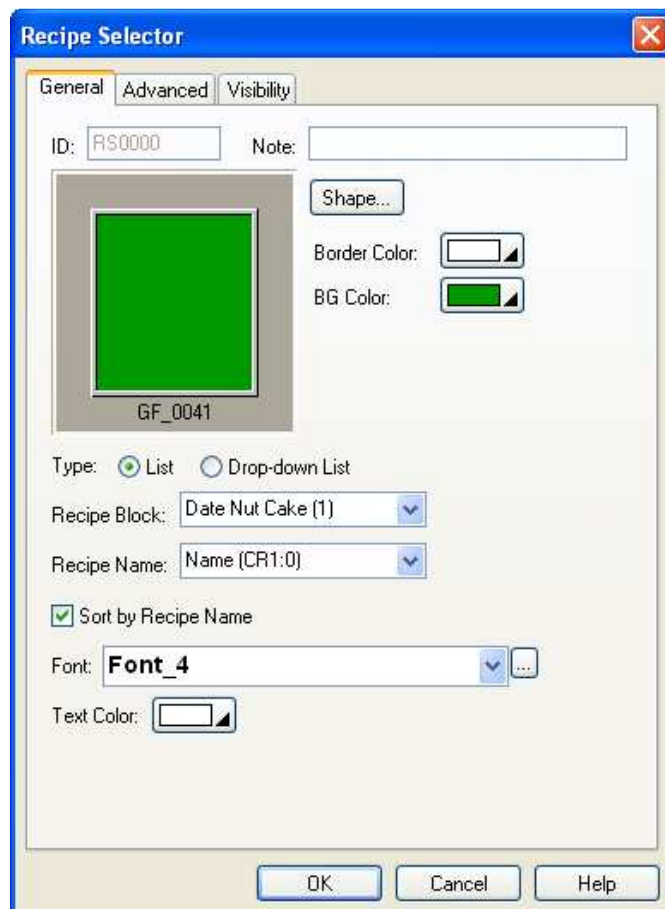
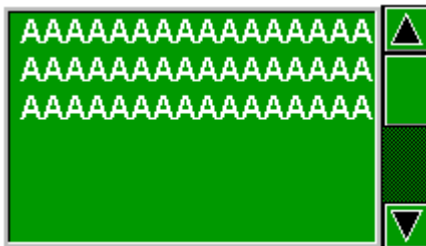

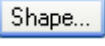

The following table describes each property in the General page.

Property	Description						
ID	The object's identifier. It is generated when the object is created and is unchangeable. The identifier is unique within the screen where the object is on. The format of the ID's for the recipe selectors is RSnnnn.						
Note	You can type a note for the object.						
Shape settings	For details about the following properties, <a href="#">Section 4.3.4 Setting up the Shape of an Object.</a>  , Border Color, BG Color						
Type	Select one of the following types for the recipe selector: <table border="1" data-bbox="534 555 1492 719"> <thead> <tr> <th>Type</th> <th>Description</th> </tr> </thead> <tbody> <tr> <td>List</td> <td>The list box is displayed at all times.</td> </tr> <tr> <td>Drop-down List</td> <td>The list box is not displayed unless the user clicks the down arrow icon next to the static-text control.</td> </tr> </tbody> </table>	Type	Description	List	The list box is displayed at all times.	Drop-down List	The list box is not displayed unless the user clicks the down arrow icon next to the static-text control.
Type	Description						
List	The list box is displayed at all times.						
Drop-down List	The list box is not displayed unless the user clicks the down arrow icon next to the static-text control.						
Recipe Block	Select the recipe block whose recipe is to be selected by the Recipe Selector object.						
Recipe Name	Select a data item from the list as the recipe name. You can select any data items with ASCII String data type as the name of the recipe from the drop down list.						
Sort by Recipe Name	Check this option to automatically sort all recipe names added to the list box.						
Font	The font of the displayed string.						
Text Color	The color of the displayed string.						



## 10.7. Displaying and Modifying Recipe Data Using Recipe Tables

### 10.7.1. Basic Operations

There are three types of recipe tables.

Type	Description																																				
Horizontal View	<p>Displays the recipes row by row and recipe data items column by column.</p> <table border="1"> <thead> <tr> <th>No.</th> <th>Name</th> <th>Dates &amp; Walnuts</th> <th>Water</th> <th>Butter</th> <th>Sugar</th> <th>Flour</th> <th>Egg</th> <th>Extra</th> </tr> </thead> <tbody> <tr> <td>0</td> <td><b>Mayonnaise Cake</b></td> <td>2</td> <td>1.00</td> <td>0.5</td> <td>1.00</td> <td>2.00</td> <td>1</td> <td>1 mayonnaise</td> </tr> <tr> <td>1</td> <td><b>Cheese Cake</b></td> <td>2</td> <td>2.00</td> <td>1.5</td> <td>2.25</td> <td>3.00</td> <td>2</td> <td>2t baking soda</td> </tr> <tr> <td>2</td> <td><b>Chocolate Cake</b></td> <td>1</td> <td>2.00</td> <td>0.0</td> <td>2.50</td> <td>2.75</td> <td>4</td> <td>2t baking soda</td> </tr> </tbody> </table> <p>The above is an example of the recipe table with horizontal view. The first row displays the data item name of each column. The other rows display one recipe per row. The first column displays recipe number. You can create scroll button groups or scroll bars to scroll the contents.</p>	No.	Name	Dates & Walnuts	Water	Butter	Sugar	Flour	Egg	Extra	0	<b>Mayonnaise Cake</b>	2	1.00	0.5	1.00	2.00	1	1 mayonnaise	1	<b>Cheese Cake</b>	2	2.00	1.5	2.25	3.00	2	2t baking soda	2	<b>Chocolate Cake</b>	1	2.00	0.0	2.50	2.75	4	2t baking soda
No.	Name	Dates & Walnuts	Water	Butter	Sugar	Flour	Egg	Extra																													
0	<b>Mayonnaise Cake</b>	2	1.00	0.5	1.00	2.00	1	1 mayonnaise																													
1	<b>Cheese Cake</b>	2	2.00	1.5	2.25	3.00	2	2t baking soda																													
2	<b>Chocolate Cake</b>	1	2.00	0.0	2.50	2.75	4	2t baking soda																													
Vertical View	<p>Displays the recipes column by column and recipe data items row by row.</p> <table border="1"> <thead> <tr> <th>No.</th> <th>0</th> <th>1</th> <th>2</th> </tr> </thead> <tbody> <tr> <td>Name</td> <td><b>Mayonnaise Cake</b></td> <td><b>Cheese Cake</b></td> <td><b>Chocolate Cake</b></td> </tr> <tr> <td>Dates &amp; Walnuts</td> <td>2</td> <td>2</td> <td>1</td> </tr> <tr> <td>Water</td> <td>1.00</td> <td>2.00</td> <td>2.00</td> </tr> <tr> <td>Butter</td> <td>0.5</td> <td>1.5</td> <td>0.0</td> </tr> <tr> <td>Sugar</td> <td>1.00</td> <td>2.25</td> <td>2.50</td> </tr> <tr> <td>Flour</td> <td>2.00</td> <td>3.00</td> <td>2.75</td> </tr> <tr> <td>Egg</td> <td>1</td> <td>2</td> <td>4</td> </tr> <tr> <td>Extra</td> <td>1 mayonnaise</td> <td>2t baking soda</td> <td>2t baking soda</td> </tr> </tbody> </table> <p>The above is an example of the recipe table with vertical view. The first column displays the data item name of each row. The other columns display one recipe per column. The first row displays the recipe number. You can create scroll button groups or scroll bars to scroll the contents.</p>	No.	0	1	2	Name	<b>Mayonnaise Cake</b>	<b>Cheese Cake</b>	<b>Chocolate Cake</b>	Dates & Walnuts	2	2	1	Water	1.00	2.00	2.00	Butter	0.5	1.5	0.0	Sugar	1.00	2.25	2.50	Flour	2.00	3.00	2.75	Egg	1	2	4	Extra	1 mayonnaise	2t baking soda	2t baking soda
No.	0	1	2																																		
Name	<b>Mayonnaise Cake</b>	<b>Cheese Cake</b>	<b>Chocolate Cake</b>																																		
Dates & Walnuts	2	2	1																																		
Water	1.00	2.00	2.00																																		
Butter	0.5	1.5	0.0																																		
Sugar	1.00	2.25	2.50																																		
Flour	2.00	3.00	2.75																																		
Egg	1	2	4																																		
Extra	1 mayonnaise	2t baking soda	2t baking soda																																		
Current Recipe	<p>Displays the recipe data items of the current recipe row by row.</p> <table border="1"> <tbody> <tr> <td>Name</td> <td><b>Mayonnaise Cake</b></td> </tr> <tr> <td>Dates &amp; Walnuts</td> <td>2</td> </tr> <tr> <td>Water</td> <td>1.00</td> </tr> <tr> <td>Butter</td> <td>0.5</td> </tr> <tr> <td>Sugar</td> <td>1.00</td> </tr> <tr> <td>Flour</td> <td>2.00</td> </tr> <tr> <td>Egg</td> <td>1</td> </tr> <tr> <td>Extra</td> <td>1 mayonnaise</td> </tr> </tbody> </table> <p>The above is an example of the current recipe. The first column displays the data item name of each row. The other column displays the current recipe. You can create scroll button groups or scroll bars to scroll the contents.</p>	Name	<b>Mayonnaise Cake</b>	Dates & Walnuts	2	Water	1.00	Butter	0.5	Sugar	1.00	Flour	2.00	Egg	1	Extra	1 mayonnaise																				
Name	<b>Mayonnaise Cake</b>																																				
Dates & Walnuts	2																																				
Water	1.00																																				
Butter	0.5																																				
Sugar	1.00																																				
Flour	2.00																																				
Egg	1																																				
Extra	1 mayonnaise																																				



### 10.7.2. Operation Options

The following operation option can be added to a recipe table. Select and set up the option in the recipe table property sheet.

Options	Description
Visibility Control	You can show or hide a recipe table by a specified bit or the current user level. Select and set up this option in the Visibility page.

### 10.7.3. Settings

You can complete all the settings of a recipe table in the Recipe Table property sheet. This sheet contains the following three pages.

- **General**  
Described in [Section 10.7.4.](#)
- **Data Item**  
Described in [Section 10.7.5.](#)
- **Visibility**  
Described in [Section 4.4.6.](#)

### 10.7.4. General Settings

This section describes how to define the general settings for a recipe table. The following is an example of the General page.

Name	AAAAAAAAAAAAAAAAAAAA
Dates & Walnuts	9999
Water	-99.99
Butter	-999.9
Sugar	-99.99
Flour	-99.99
Egg	9999
Extra	AAAAAAAAAAAAAAAAAAAA

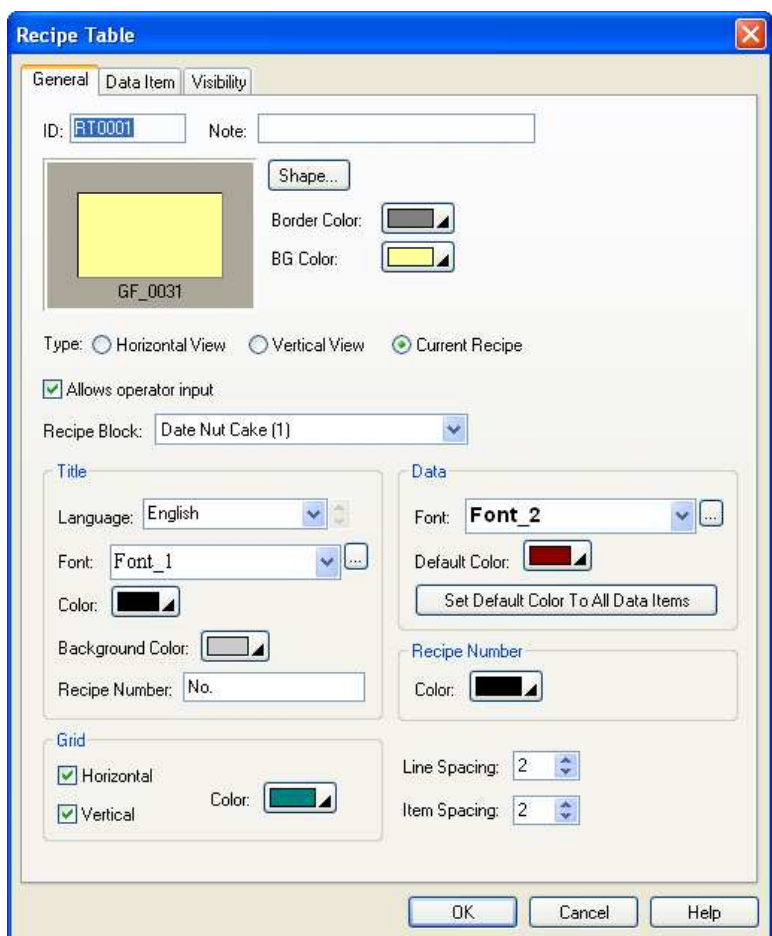

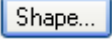

The following table describes each property in the General page.

Property		Description								
ID		The object's identifier. It is generated when the object is created and is unchangeable. The identifier is unique within the screen where the object is on. The format of the ID's for the recipe tables is RTnnnn.								
Note		You can type a note for the object.								
Shape settings		For details about the following properties, <a href="#">Section 4.3.4 Setting up the Shape of an Object.</a>  , Border Color, BG Color								
Type		<p>Select one of the following types for the recipe table:</p> <table border="1"> <thead> <tr> <th>Type</th> <th>Description</th> </tr> </thead> <tbody> <tr> <td>Horizontal View</td> <td>Displays the recipes row by row and recipe data items column by column.</td> </tr> <tr> <td>Vertical View</td> <td>Displays the recipes column by column and recipe data items row by row.</td> </tr> <tr> <td>Current Recipe</td> <td>Displays the recipe data items of the current recipe row by row.</td> </tr> </tbody> </table>	Type	Description	Horizontal View	Displays the recipes row by row and recipe data items column by column.	Vertical View	Displays the recipes column by column and recipe data items row by row.	Current Recipe	Displays the recipe data items of the current recipe row by row.
Type	Description									
Horizontal View	Displays the recipes row by row and recipe data items column by column.									
Vertical View	Displays the recipes column by column and recipe data items row by row.									
Current Recipe	Displays the recipe data items of the current recipe row by row.									
Allows operator input		Check this option if you allow the operator to update the value of the recipe data item.								
Recipe Block		Select the recipe whose collected data is to be displayed by the object.								
Title	Language	Select a language so you can view and edit the settings of the title row for that language.								
	Font	Select a font for the title text.								
	Color	Select a color for the title text.								
	Background Color	Select a color for the background of the title row.								
	Recipe Number	Specifies the title for the recipe number column.								
Grid	Vertical	Check this option if you want the object to have vertical grids.								
	Horizontal	Check this option if you want the object to have horizontal grids.								
	Color	Select a color for the grids.								
Data	Font	Select a font for displaying data.								
	Default Color	Select a color as the default color for displaying data.								
	Set Default Color to All Data Items	Click this button to set the colors of all the data items to the Default Color.								
Recipe Number	Color	Select a color for the recipe number.								
Line Spacing		Specifies the extra space in pixels for two adjacent rows in the table.								
Item Spacing		Specifies the extra space for every column in the table.								



### 10.7.5. Data Item Settings

This section describes how to define the display format for the values of each data item. The following is an example of the Data Item page.

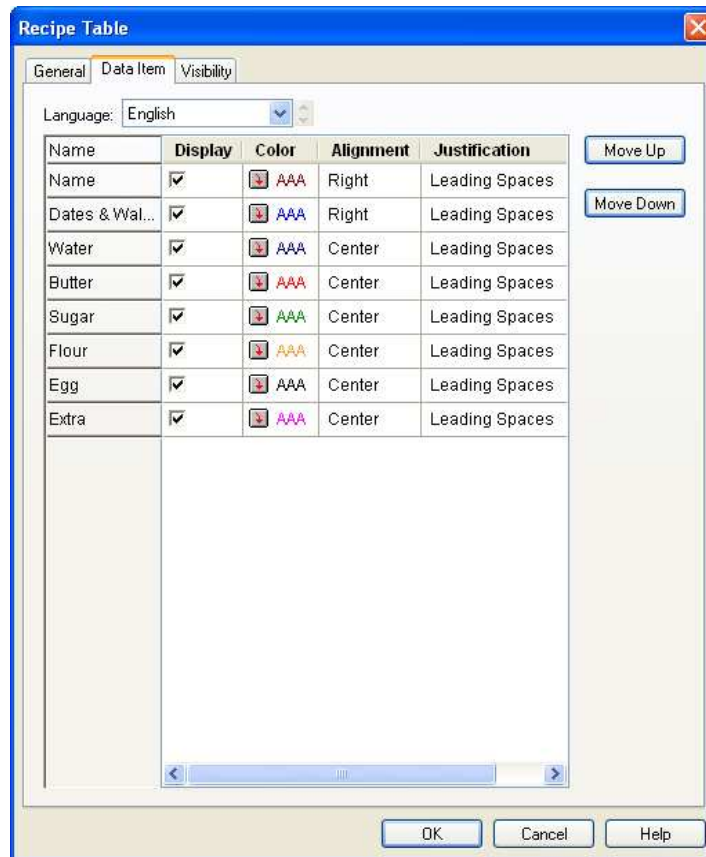

The following table describes each property in the Data Item page.

Property		Description							
Language		Select a language so you can view and edit the settings for that language.							
Row #n of the property table	Name	The name of data item #n. The data item names are defined in the Data Item page of the Data Logger dialog box.							
	Display	Check this option if you want the object to display data item #n.							
	Color	Select a color for displaying data item #n.							
	Alignment	The alignment for displaying data item #n. There are three types of alignment: Left, Center, and Right.							
	Justification	The justification for displaying data item #n. There are three types of justification: <table border="1" data-bbox="411 1630 1497 1800"> <thead> <tr> <th>Option</th> <th>Description</th> </tr> </thead> <tbody> <tr> <td>Zero Suppress</td> <td>The leading digits will not display when they are 0.</td> </tr> <tr> <td>Leading Zeros</td> <td>All digits will display.</td> </tr> <tr> <td>Leading Spaces</td> <td>The leading digits will display as blank character when they are 0.</td> </tr> </tbody> </table>	Option	Description	Zero Suppress	The leading digits will not display when they are 0.	Leading Zeros	All digits will display.	Leading Spaces
Option	Description								
Zero Suppress	The leading digits will not display when they are 0.								
Leading Zeros	All digits will display.								
Leading Spaces	The leading digits will display as blank character when they are 0.								
Move Up		Click the button to move the selected data item before the previous data item. The Move Up button will help you to reorder the display sequence of the data items It will not be available when multiple rows are selected or no row is selected.							
Move Down		Click the button to move the selected data item after the next data item. The Move Down button will help you to reorder the display sequence of the data items It will not be available when multiple rows are selected or no row is selected.							



## CHAPTER 11

# ALARMS AND ALARM DISPLAYS

<b>11.1. Using Alarms .....</b>	<b>1</b>
<b>11.2. Setting Up Alarm Processing .....</b>	<b>2</b>
<b>11.3. Working with Alarm Blocks .....</b>	<b>4</b>
11.3.1. Creating an alarm block.....	4
11.3.2. Importing and exporting an alarm block.....	4
11.3.3. Deleting an alarm block .....	4
11.3.4. Embedding Variable in the Appended Text of Alarm Message.....	5
<b>11.4. Discrete Alarm Blocks .....</b>	<b>6</b>
11.4.1. Settings.....	6
<b>11.5. Analog Alarm Blocks .....</b>	<b>9</b>
11.5.1. Settings.....	9
<b>11.6. Alarm Displays .....</b>	<b>13</b>
11.6.1. Basic Operations .....	13
11.6.2. Operation Options.....	15
11.6.3. Settings.....	15
11.6.4. General Settings.....	16



In order to use alarm display for your application, you need to set up alarm processing first and then define an alarm block. This chapter describes how to set up the alarm processing and alarm block. It also describes how to configure the alarm display to show alarm history, alarm count, active alarm and alarm marquee.

## 11.1. Using Alarms

To use an alarm in your application, please follow the procedure as below:

1. Setting up alarm processing  
Described in [Section 11.2](#)
2. Creating and configuring discrete alarm blocks or analog alarm blocks  
Described in [Section 11.3](#) and [Section 11.4](#)
3. Creating and configuring alarm displays  
Described in [Section 11.5](#)

You can use command flag setting in command block or function button to request the panel to clear alarm history or clear alarm count.

To know how to set up the command flag in command block, please see [Section 3.5.1 Command Block and Status Words](#). To know how to define a function button, please see [Section 5.4.1 Basic Operations](#) of function buttons.

## 11.2. Setting Up Alarm Processing

You can set up the alarm processing with the Alarm Properties dialog box. In this dialog, you can determine the required memory for alarm logging buffer, choose default color and font for the alarm message, specify how to save the alarm history records to a text file and configure the global alarm marquee if you want to show it on the screen. To open the dialog box of alarm processing, please double click the node named Alarms in the PM Designer's Project Manager tool window. The following is an example of the Alarm Properties dialog box.

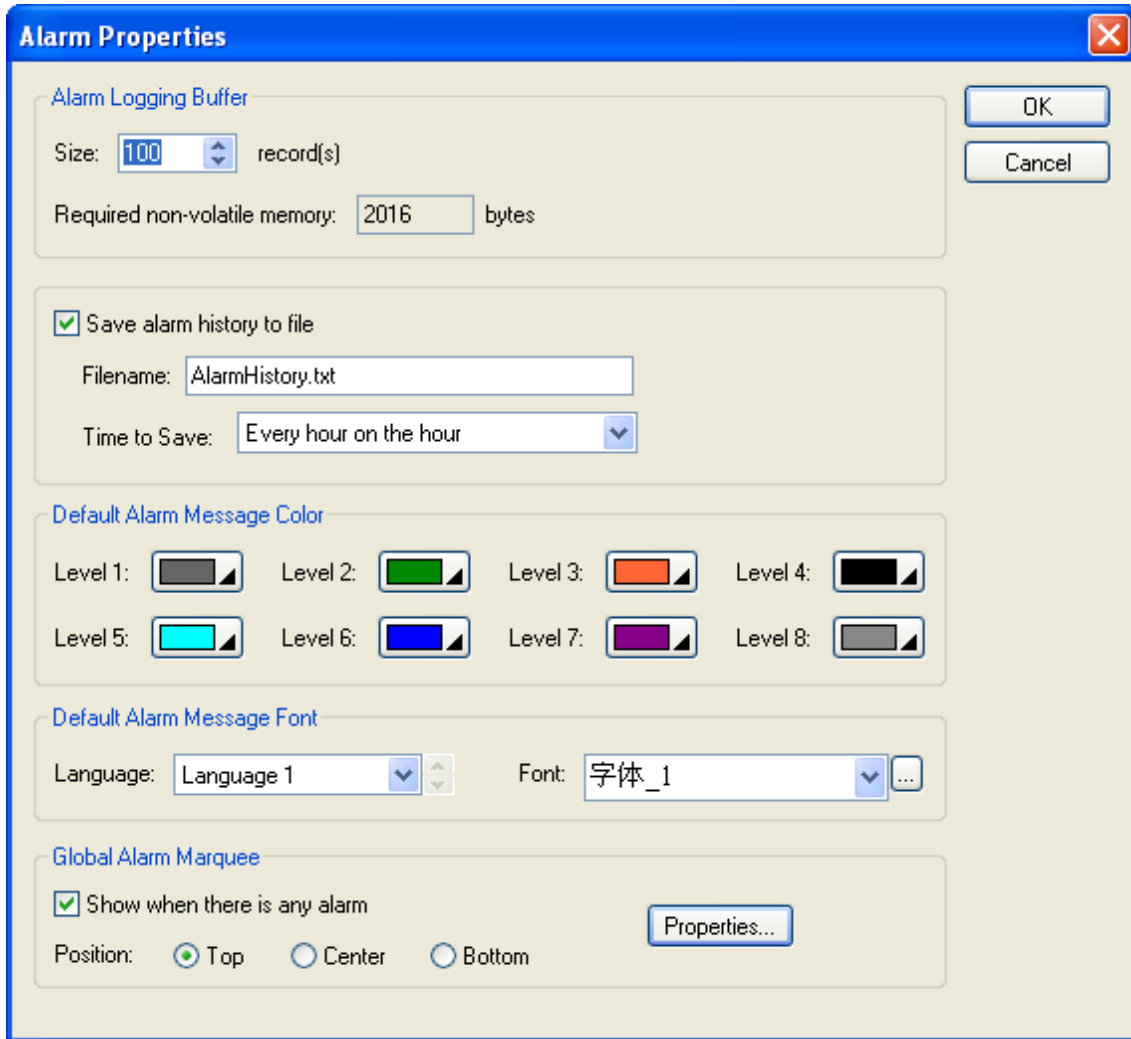

The table below describes each property in the Alarm Properties dialog.

Property		Description
Alarm Logging Buffer	Size	The maximum number of records that the alarm logging buffer can hold. For example, 100 means when the 101 <sup>st</sup> alarm happens, the 1 <sup>st</sup> record will be overwritten.
	Required non-volatile memory	The size of the alarm logging buffer. The unit is byte. The formula to calculate the size is: Alarm Logging Buffer Size = Number of Records * 20 + 16

Continued

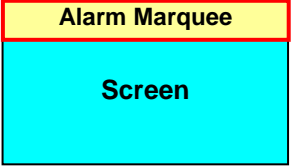
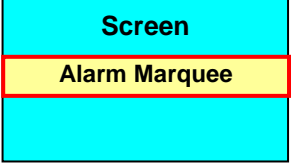
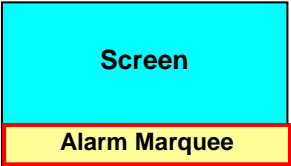

Property		Description		
Save alarm history to File	Save alarm history to file	Check this option so the newly alarm history record will be written to a specified file periodically. Each time when performing this operation, the panel writes only the record that are not saved to a file before.		
	File Name	The filename or the prefix of the filename of the file to save the alarm record. The alarm records are saved in text format and the file extension name must be ".txt". You can use any text editor and Microsoft Excel to view the alarm records directly. This item is available when the option Save alarm history to file is checked.		
	Time to Save	Specifies the period to save the alarm history records. This item is available when the option Save alarm history to file is checked. There are nine kinds of period available: Every hour on the hour ; Every 8 hours (00:00, 08:00, 16:00) ; Every 12 hours (00:00, 12:00) Every day at 00:00; Every day at 08:00; Every day at 12:00; Every Sunday at 00:00; Every Monday at 00:00; Every month's first day at 00:00.		
Default Alarm Message Color	Level 1, Level 2... Level 8	Select a default color for alarm level 1,2...8. The alarm display will show an alarm message with this color if that alarm is defined as a level 1,2...8 alarm.		
Default Alarm Message Font	Language	Select a default language so you can view and edit the language dependent settings in the Text group for that language. The language dependent properties in the Text group include Font and Alarm Status Abbreviation.		
	Font	Select a default font for the text of the alarm message.		
Global Alarm Marquee	Show when there is any alarm	Check this option if you want to show global alarm marquee on the current screen when there is any alarm.		
	Position	Select one of the following 3 positions for the global alarm marquee to show up.		
		<b>Position</b>	<b>Description</b>	
		Top	The global alarm marquee shows up on the top of the screen.	
Center		The global alarm marquee shows up in the center of the screen.		
Bottom	The global alarm marquee shows up at the bottom of the screen.			
Properties	Click the button to bring up the Alarm Display dialog box to set up the properties of the global alarm marquee. Please see <a href="#">Section 11.4.4</a> for details.			



## 11.3. Working with Alarm Blocks

### 11.3.1. Creating an alarm block

To create a discrete alarm block, you may do one of the followings:

- 1) In the PM Designer's Project Manager tool window, right-click the Alarms node of the concerned panel application and select Add Discrete Alarm Block.
- 2) In the PM Designer's menu bar, click Panel to bring up the Panel sub-menu. Click Discrete Alarm Block in the Panel sub-menu to bring up the pop-up menu. Select Add in the pop-up menu.

To create an analog alarm block, you may do one of the followings:

- 1) In the PM Designer's Project Manager tool window, right-click the Alarms node of the concerned panel application and select Add Analog Alarm Block.
- 2) In the PM Designer's menu bar, click Panel to bring up the Panel sub-menu. Click Analog Alarm Block in the Panel sub-menu to bring up the pop-up menu. Select Add in the pop-up menu.

### 11.3.2. Importing and exporting an alarm block

To import an alarm block, right-click the Alarms node and then select Import Alarm Block...in the PM Designer's Project Manager window. Select \*.alm file in the Open file dialog and then click Open.

To export a discrete alarm block, right-click the node of the desired discrete alarm block and then select Export Alarm Block.... in the PM Designer's Project Manager window.

To export an analog alarm block, right-click the node of the desired analog alarm block and then select Export Alarm Block.... in the PM Designer's Project Manager window.

### 11.3.3. Deleting an alarm block

To delete a discrete alarm block, you may do one of the followings:

- 1) In the PM Designer's Project Manager window, right-click the node of the desired discrete alarm block and then select Delete.
- 2) In the PM Designer's menu bar, click Panel to bring up the Panel sub-menu. Click Discrete Alarm Block in the Panel sub-menu to bring up the Discrete Alarm Block pop-up menu. Select Delete in the pop-up menu to bring up the discrete alarm block list of the current panel application. Select the desired discrete alarm block in the list.

To delete an analog alarm block, you may do one of the followings:

- 1) In the PM Designer's Project Manager window, right-click the node of the desired analog alarm block and then select Delete.
- 2) In the PM Designer's menu bar, click Panel to bring up the Panel sub-menu. Click Analog Alarm Block in the Panel sub-menu to bring up the Analog Alarm Block pop-up menu. Select Delete in the pop-up menu to bring up the analog alarm block list of the current panel application. Select the desired analog alarm block in the list.



### 11.3.4. Embedding Variable in the Appended Text of Alarm Message

1. The appended text can have one embedded variable.
2. Use the following format to specify an embedded variable:  
`@ @ read_address < display_format >`

For example, the following embedded variable in the appended text will display the **32-bit floating point number** stored in **W300** with the format of **4 total digits** and **1 fractional digit**.

(Current temperature: @ @ W300 < F4.1 > °C)

If the value of W300 is 123.456 when the alarm occurs, the following text will be appended to its alarm message:

(Current temperature: 123.4 °C)

3. The *read\_address* can be any valid word address.
4. The *display\_format* has the following format:  
*Dt.f*  
 The *D* is a one-letter or two-letter code to specify the data type.  
 The *t* is a number to specify the total number of digits to be displayed.  
 The *f* is a number to specify the total number of fractional digits to be displayed.  
 The following table shows the rule of specifying the *display\_format*.

Data Type	<i>D</i> (Data Type)	<i>t</i> (Total Digits)	<i>f</i> (Fractional Digits)
16-bit Unsigned Integer	U	1~5	$t \geq f \geq 0$
16-bit Signed Integer	S	1~5	$t \geq f \geq 0$
16-bit BCD Integer	D	1~4	$t \geq f \geq 0$
32-bit Unsigned Integer	UD	1~10	$t \geq f \geq 0$
32-bit Signed Integer	SD	1~10	$t \geq f \geq 0$
32-bit BCD Integer	DD	1~8	$t \geq f \geq 0$
32-bit Floating Point Number	F	1~10	$t \geq f \geq 0$

5. Note that the embedded variable specified in the appended text of the first language will be used in the appended text of all other languages no matter what embedded variables are specified in those appended text.

## 11.4. Discrete Alarm Blocks

You can set up a discrete alarm block with the Discrete Alarm Block dialog box. There are two ways to open the dialog box:

- 1) In the PM Designer's Project Manager window, move the mouse to the node of the desired discrete alarm block and double click the node or right-click the node and then select Properties.
- 2) In the PM Designer's menu bar, click Panel to bring up the Panel sub-menu. Click Discrete Alarm Block in the Panel sub-menu to bring up the Discrete Alarm Block pop-up menu. Select Properties in the pop-up menu to bring up the discrete alarm block list of the current panel application. Select the desired discrete alarm block in the list.

### 11.4.1. Settings

Use the dialog box to define all the settings for a discrete alarm block. The following is an example of the discrete alarm block dialog.

**Discrete Alarm Block**
✖

Block Name: 
Block ID: 
OK

Type: 
Read Address: 
Cancel

Block Size: 
Read Interval:  seconds

No.	Address	Use	Message
1	\$U10.0	<input checked="" type="checkbox"/>	Invalid input number
2	\$U10.1	<input checked="" type="checkbox"/>	No1. motor error
3	\$U10.2	<input checked="" type="checkbox"/>	Unstable voltage
4	\$U10.3	<input checked="" type="checkbox"/>	Temperature too high
5	\$U10.4	<input checked="" type="checkbox"/>	Improper operation
6	\$U10.5	<input checked="" type="checkbox"/>	Sense invalid operation
7	\$U10.6	<input checked="" type="checkbox"/>	Program running error
8	\$U10.7	<input checked="" type="checkbox"/>	Pressure too low
9	\$U10.8	<input checked="" type="checkbox"/>	Gear broken
10	\$U10.9	<input checked="" type="checkbox"/>	Emergency Stop

**Discrete Alarm**

Address:

Level:  ID:

Message

Language:

Text:

Appended Text:

Record alarm       Sound Buzzer

Display message

Display screen

Require Acknowledgement

Record ACK

Notification      Bit:

Tip Screen

Alt+Up: Move item up
Alt+Down: Move item down



The table below describes some properties in the dialog.

Property	Description										
Block Name	The discrete alarm block's name. The maximum length of the name is 20 characters.										
Block ID	The discrete alarm block's ID number. Select a number between 0 and 15. The number is unique among all discrete alarm blocks of the panel application.										
Type	<p>Specifies the memory type which is used to allocate the discrete alarm block. There are four types:</p> <table border="1"> <thead> <tr> <th>Type</th> <th>Description</th> </tr> </thead> <tbody> <tr> <td>Bits</td> <td>Select Bits to create a discrete alarm block starting from the bit device <b>M</b> with <b>N</b> continuous bits</td> </tr> <tr> <td>Bits of Word Device</td> <td>Select Bits of Word Device to create a discrete alarm block starting from the bit 0 of the word device <b>M</b> with <b>N</b> continuous bits of the word device.</td> </tr> <tr> <td>Word Value</td> <td>Select Word Value to create a discrete alarm block at word device <b>M</b>. An alarm will occur if the value of <b>M</b> is between 0 and <b>N</b>.</td> </tr> <tr> <td>Random Bits</td> <td>Select Random Bits to create a discrete alarm block with <b>N</b> specified random bits.</td> </tr> </tbody> </table> <p><b>Legend:</b> <b>M</b>: An address specified in Read Address field <b>N</b>: A size specified in Block Size/Maximum field.</p>	Type	Description	Bits	Select Bits to create a discrete alarm block starting from the bit device <b>M</b> with <b>N</b> continuous bits	Bits of Word Device	Select Bits of Word Device to create a discrete alarm block starting from the bit 0 of the word device <b>M</b> with <b>N</b> continuous bits of the word device.	Word Value	Select Word Value to create a discrete alarm block at word device <b>M</b> . An alarm will occur if the value of <b>M</b> is between 0 and <b>N</b> .	Random Bits	Select Random Bits to create a discrete alarm block with <b>N</b> specified random bits.
Type	Description										
Bits	Select Bits to create a discrete alarm block starting from the bit device <b>M</b> with <b>N</b> continuous bits										
Bits of Word Device	Select Bits of Word Device to create a discrete alarm block starting from the bit 0 of the word device <b>M</b> with <b>N</b> continuous bits of the word device.										
Word Value	Select Word Value to create a discrete alarm block at word device <b>M</b> . An alarm will occur if the value of <b>M</b> is between 0 and <b>N</b> .										
Random Bits	Select Random Bits to create a discrete alarm block with <b>N</b> specified random bits.										
Read Address	<p>Specifies the starting address of an alarm block to monitor the status of alarms.</p> <p>Click  to enter an address for this field. Click  to select a tag for this field.</p>										
Block Size / Maximum	<p>Specifies the block size of an alarm block. The unit is bit. The maximum block size or maximum value you can specify depends on the type you select. The following table lists the limitation of each type:</p> <table border="1"> <thead> <tr> <th>Type</th> <th>Maximum block size/value</th> </tr> </thead> <tbody> <tr> <td>Bits</td> <td>256</td> </tr> <tr> <td>Bits of Word Device</td> <td>256</td> </tr> <tr> <td>Word Value</td> <td>0-511</td> </tr> <tr> <td>Random Bits</td> <td>64</td> </tr> </tbody> </table>	Type	Maximum block size/value	Bits	256	Bits of Word Device	256	Word Value	0-511	Random Bits	64
Type	Maximum block size/value										
Bits	256										
Bits of Word Device	256										
Word Value	0-511										
Random Bits	64										
Read Interval	Specifies the period between 1 to 3600 seconds that the panel reads Alarm Block and checks the state of every bit in the block. The shorter the Read Interval is, the faster the alarm display object will be refreshed, but it will make other objects refresh slower.										

To specify all discrete alarms, you need to do the setting on the discrete alarm list and discrete alarm properties field. The discrete alarm list located on the bottom-left part of the dialog shows all the discrete alarms in the alarm block. The discrete alarm properties field located on the right of the list shows all the properties of the selected discrete alarm.

The following table describes each column in the discrete alarm list.

Column	Description
No.	The number of the discrete alarm in the alarm block.
Address/Bit No./Value	If the type is Bits or Random Bits, the column shows the address of the discrete alarm; If the type is Bits of Word Device, the column shows the bit no of the discrete alarm. If the type is Word Value, the column shows the value of the discrete alarm.
Use	Check this option if you want to use discrete alarm #n.
Message	Displays specified alarm message in selected language.







You need to make selection before editing the discrete alarm. To select a discrete alarm, click the row of that alarm in the list. To select multiple rows, click the row on its header column and use Ctrl + Click to add a row to the selection.

If multiple rows are selected, any modification on the common properties such as Level, Record alarm, Sound Buzzer, Display message, Display screen, Required Acknowledgement, Record ACK, Notification, Tip Screen...will apply to all selected discrete alarms





The following table describes each properties for the selected discrete alarm.

Property		Description															
Address/Bit No./Value		Indicates the status of its corresponding alarm. A bit with high (on) state indicates the corresponding alarm is active. A bit with low (off) state indicates the corresponding alarm is clear. The meaning of the field depends on the selected type. <table border="1" data-bbox="472 405 1481 725"> <thead> <tr> <th>Field Name</th> <th>Type</th> <th>Description</th> </tr> </thead> <tbody> <tr> <td>Address</td> <td>Bits</td> <td>Shows the address of the selected discrete alarm</td> </tr> <tr> <td>Bit No.</td> <td>Bits of Word Device</td> <td>Shows the bit no of the selected discrete alarm</td> </tr> <tr> <td>Value</td> <td>Word Value</td> <td>Shows the value of the selected discrete alarm</td> </tr> <tr> <td>Address</td> <td>Random Bits</td> <td>Specifies the bit variable of the selected discrete alarm. Click  to enter an address. Click  to select a tag.</td> </tr> </tbody> </table>	Field Name	Type	Description	Address	Bits	Shows the address of the selected discrete alarm	Bit No.	Bits of Word Device	Shows the bit no of the selected discrete alarm	Value	Word Value	Shows the value of the selected discrete alarm	Address	Random Bits	Specifies the bit variable of the selected discrete alarm. Click  to enter an address. Click  to select a tag.
Field Name	Type	Description															
Address	Bits	Shows the address of the selected discrete alarm															
Bit No.	Bits of Word Device	Shows the bit no of the selected discrete alarm															
Value	Word Value	Shows the value of the selected discrete alarm															
Address	Random Bits	Specifies the bit variable of the selected discrete alarm. Click  to enter an address. Click  to select a tag.															
Level		Select a level for the alarm between 1 and 8.															
ID		Specifies the alarm ID The maximum length of the ID is 6 characters.															
Message	Language	Select an existing language that you are setting the message for.															
	Import All...	Click the button to import the texts of *.csv file and saves the texts as the alarm messages for the current language.															
	Export All...	Click the button to export all the messages for selected language to *.csv file.															
	Text	Specifies the text for the current language. The text will be shown when the alarm is active.															
	Appended Text	Specifies the appended text for the current language. For details, please see <a href="#">Section 11.3.4 Embedding Variable in the Appended Text of Alarm Message</a> .															
Record alarm		Check this option if you want to record the alarm in the alarm display object.															
Sound Buzzer		Check this option if you want the panel to play sound buzzer when the alarm is active or clear.															
Display message		Check this option if you want the panel to display message automatically when the alarm is active or clear. This field can be checked only when the Display screen is unchecked.															
Display screen	<Check Box>	Check this option if you want the panel to display a window screen automatically when the alarm is active or clear. This field can be checked only when the Display message is unchecked.															
		Select a window screen to display when the alarm is active or clear. The field is available when the Display Screen is selected. Note that only Window Screens will be available for selecting. Please see ?? to create a window screen.															
Required Acknowledgement	<Check Box>	Check this option if you want the operator to acknowledge an alarm. When an alarm become active, the panel display alarm message or screen with ACK button if Required Acknowledgement is selected. The operator should press the ACK button to acknowledge the alarm and have the panel start to refresh the current screen again. This field is available when either Display message or Display screen is selected.															
	Record ACK	Check this option if you want to record ACK in the alarm display object															
	Notification	Check this option if you want to notify the specified bit when the ACK button is clicked.															
	Bit	Specifies the bit that receives the notification.															
Tip Screen	<Check Box>	Check this option if you want to display a screen when you select the corresponding alarm on the alarm display object.															
		Select a window screen as the tip screen															
Play multimedia		Check this option if you want the panel to play multimedia when the alarm is active or clear.															
File Name		Specifies the file name of the multimedia															



## 11.5. Analog Alarm Blocks

You can set up an analog alarm block with the Analog Alarm Block dialog box. There are two ways to open the dialog box:

- 1) In the PM Designer's Project Manager window, move the mouse to the node of the desired analog alarm block and double click the node or right-click the node and then select Properties.
- 2) In the PM Designer's menu bar, click Panel to bring up the Panel sub-menu. Click Analog Alarm Block in the Panel sub-menu to bring up the Analog Alarm Block pop-up menu. Select Properties in the pop-up menu to bring up the analog alarm block list of the current panel application. Select the desired analog alarm block in the list.

### 11.5.1. Settings

Use the dialog box to define all the settings for an analog alarm block. The following is an example of the analog alarm block dialog.

**Analog Alarm Block**
✕

Block Name: 
Block ID:

Type: 
Read Address:

Block Size:  words
Read Interval:  seconds

No.	Address	Use	Message
1	\$U0	<input checked="" type="checkbox"/> Low Low	WARN00: NON-FACTORY DE
2	\$U0	<input checked="" type="checkbox"/> Low	WARN01: CPU BOARD NOT ..
3	\$U0	<input checked="" type="checkbox"/> High	WARN02: RTC CHIP ERROR
4	\$U0	<input checked="" type="checkbox"/> High High	WARN03: NV-RAM CHIP ERR
5	\$U1	<input checked="" type="checkbox"/> Low Low	WARN04: TEMP. BOARD NO..
6	\$U1	<input checked="" type="checkbox"/> Low	WARN05: TEMP. BOARD ER..
7	\$U1	<input checked="" type="checkbox"/> High	WARN06: PANEL BOARD NO.
8	\$U1	<input checked="" type="checkbox"/> High High	WARN07: ANALOG I/P ERROF
9	\$U2	<input checked="" type="checkbox"/> Low Low	WARN08: ANALOG I/P NOT R.
10	\$U2	<input checked="" type="checkbox"/> Low	WARN09: ANALOG I/P Intr. Err
11	\$U2	<input checked="" type="checkbox"/> High	WARN10: SAVE-ALL MALFUN
12	\$U2	<input checked="" type="checkbox"/> High High	WARN11: SAVE-ALL STOPPI..
13	\$U3	<input checked="" type="checkbox"/> Low Low	WARN12:
14	\$U3	<input checked="" type="checkbox"/> Low	WARN13:
15	\$U3	<input checked="" type="checkbox"/> High	WARN14:
16	\$U3	<input checked="" type="checkbox"/> High High	WARN15:
17			

**Analog Alarm**

Alarm Type:       Data Type:

Address:

Limit:       Hysteresis:  %

Level:       ID:

**Message**

Language:            

Text:

Appended Text:

Record alarm       Sound Buzzer

Display alarm message

Display screen           

Require Acknowledgement



Record ACK       Notification

Tip Screen

Alt+Up: Move item up
Alt+Down: Move item down



The table below describes each property in the dialog.

Property	Description						
Block Name	The analog alarm block's name. The maximum length of the name is 20 characters.						
Block ID	The analog alarm block's ID number. Select a number between 64 and 79. The number is unique among all analog alarm blocks of the panel application.						
Type	<p>Specifies the type of the analog alarm block. There are two types:</p> <table border="1"> <thead> <tr> <th>Type</th> <th>Description</th> </tr> </thead> <tbody> <tr> <td>Continuous Words</td> <td>Select Continuous Words to create an analog alarm block starting from the word device <b>M</b> with <b>N</b> continuous words</td> </tr> <tr> <td>Random Words</td> <td>Select Random Words to create an analog alarm block with <b>N</b> specified random words.</td> </tr> </tbody> </table> <p><b>Legend:</b> <b>M</b>: An address specified in Read Address field    <b>N</b>: A size specified in Block Size.</p>	Type	Description	Continuous Words	Select Continuous Words to create an analog alarm block starting from the word device <b>M</b> with <b>N</b> continuous words	Random Words	Select Random Words to create an analog alarm block with <b>N</b> specified random words.
Type	Description						
Continuous Words	Select Continuous Words to create an analog alarm block starting from the word device <b>M</b> with <b>N</b> continuous words						
Random Words	Select Random Words to create an analog alarm block with <b>N</b> specified random words.						
Read Address	<p>Specifies the starting address of an alarm block to monitor the status of alarms.</p> <p>Click  to enter an address for this field. Click  to select a tag for this field.</p>						
Block Size	<p>Specifies the block size of an alarm block. The unit is word. The maximum block size you can specify depends on the type you select.</p> <table border="1"> <thead> <tr> <th>Type</th> <th>Maximum block size</th> </tr> </thead> <tbody> <tr> <td>Continuous Words</td> <td>16</td> </tr> <tr> <td>Random Words</td> <td>64</td> </tr> </tbody> </table>	Type	Maximum block size	Continuous Words	16	Random Words	64
Type	Maximum block size						
Continuous Words	16						
Random Words	64						
Read Interval	Specifies the period between 1 to 3600 seconds that the panel reads Alarm Block and checks the state of every bit in the block. The shorter the Read Interval is, the faster the alarm display object will be refreshed, but it will make other objects refresh slower.						

To specify all analog alarms, you need to do the setting on the analog alarm list and analog alarm properties field. The analog alarm list located on the bottom-left part of the dialog shows all the analog alarms in the alarm block. The analog alarm properties field located on the right of the list shows all the properties of the selected analog alarm.

The following table describes each column in the analog alarm list.







Column	Description
No.	The number of the analog alarm in the alarm block.
Address	Shows the address of the analog alarm.
Use	Check this option if you want to use analog alarm #n.
Message	Displays specified alarm message in selected language.

You need to make selection before editing the analog alarm. To select an analog alarm, click the row of that alarm in the list. To select multiple rows, click the row on its header column and use Ctrl + Click to add a row to the selection.

If multiple rows are selected, any modification on the common properties such as Level, Record alarm, Sound Buzzer, Display message, Display screen, Required Acknowledgement, Record ACK, Notification, Tip Screen...will apply to all selected analog alarms



The following table describes each column in the analog alarm list.

Property		Description										
Alarm Type		There are four types of the analog alarm:										
		<table border="1"> <thead> <tr> <th>Type</th> <th>Description</th> </tr> </thead> <tbody> <tr> <td>Low Low</td> <td>An alarm will occur if the value of the destination variable is lower than or equal to the Low Low Limit.</td> </tr> <tr> <td>Low</td> <td>An alarm will occur if the value of the destination variable is equal to Low Limit or between Low Limit and Low Low Limit.</td> </tr> <tr> <td>High</td> <td>An alarm will occur if the value of the destination variable is equal to High Limit or between High Limit and High High Limit.</td> </tr> <tr> <td>High High</td> <td>An alarm will occur if the value of the destination variable is higher than or equal to the High High Limit.</td> </tr> </tbody> </table>	Type	Description	Low Low	An alarm will occur if the value of the destination variable is lower than or equal to the Low Low Limit.	Low	An alarm will occur if the value of the destination variable is equal to Low Limit or between Low Limit and Low Low Limit.	High	An alarm will occur if the value of the destination variable is equal to High Limit or between High Limit and High High Limit.	High High	An alarm will occur if the value of the destination variable is higher than or equal to the High High Limit.
		Type	Description									
		Low Low	An alarm will occur if the value of the destination variable is lower than or equal to the Low Low Limit.									
		Low	An alarm will occur if the value of the destination variable is equal to Low Limit or between Low Limit and Low Low Limit.									
High	An alarm will occur if the value of the destination variable is equal to High Limit or between High Limit and High High Limit.											
High High	An alarm will occur if the value of the destination variable is higher than or equal to the High High Limit.											
Data Type	The data type of the destination variable. The supported data types include: 16-Bit Unsigned Integer, 32-Bit Unsigned Integer, 16-Bit Signed Integer, 32-Bit Signed Integer, 16-Bit BCD, 32-Bit BCD, 32-Bit Floating Point.											
Address		Indicates the status of its corresponding alarm.										
		<table border="1"> <thead> <tr> <th>Type</th> <th>Description</th> </tr> </thead> <tbody> <tr> <td>Continuous Words</td> <td>Shows the address of the selected analog alarm.</td> </tr> <tr> <td>Random Words</td> <td>Specifies the word variable of the selected analog alarm. Click  to enter an address. Click  to select a tag.</td> </tr> </tbody> </table>	Type	Description	Continuous Words	Shows the address of the selected analog alarm.	Random Words	Specifies the word variable of the selected analog alarm. Click  to enter an address. Click  to select a tag.				
		Type	Description									
Continuous Words	Shows the address of the selected analog alarm.											
Random Words	Specifies the word variable of the selected analog alarm. Click  to enter an address. Click  to select a tag.											
Limit	Set a limit for the alarm. The value range of the limit depends on the specified data type.											
Hysteresis		Set the difference between the value where the alarm turns ON from turning OFF and the value where it turns OFF from turning ON. If the alarm type is Low Low or Low, the range is between the Limit and Limit + Limit * Hysteresis/100. If the alarm type is High High or High, the range is between the Limit and Limit - Limit * Hysteresis/100.										
Level		Select a level for the alarm between 1 and 8.										
ID		Specifies the alarm ID The maximum length of the ID is 6 characters.										
Message	Language	Select an existing language that you are setting the message for.										
	Import All...	Click the button to import the texts of *.csv file and saves the texts as the alarm messages for the current language.										
	Export All...	Click the button to export all the messages for selected language to *.csv file.										
	Text	Specifies the text for the current language. The text will be shown when the alarm is active.										
	Appended Text	Specifies the appended text for the current language. For details, please see <a href="#">Section 11.3.4 Embedding Variable in the Appended Text of Alarm Message</a> .										
Record alarm		Check this option if you want to record the alarm in the alarm display object.										
Sound Buzzer		Check this option if you want the panel to play sound buzzer when the alarm is active or clear.										
Display alarm message		Check this option if you want the panel to display message automatically when the alarm is active or clear. This field can be checked only when the Display screen is unchecked.										
Display screen	<Check Box>	Check this option if you want the panel to display a window screen automatically when the alarm is active or clear. This field can be checked only when the Display message is unchecked.										
		Select a window screen to display when the alarm is active or clear. The field is available when the Display Screen is selected. Note that only Window Screens will be available for selecting. Please see ?? to create a window screen.										

Continued



Property		Description
Required Acknowledgement	<Check Box>	Check this option if you want the operator to acknowledge an alarm. When an alarm become active, the panel display alarm message or screen with ACK button if Required Acknowledgement is selected. The operator should press the ACK button to acknowledge the alarm and have the panel start to refresh the current screen again. This field is available when either Display message or Display screen is selected.
	Record ACK	Check this option if you want to record ACK in the alarm display object
	Notification	Check this option if you want to notify the specified bit when the ACK button is clicked.
	Bit	Specifies the bit that receives the notification.
Tip Screen	<Check Box>	Check this option if you want to display a screen when you select the corresponding alarm on the alarm display object.
		Select a window screen as the tip screen
Play multimedia		Check this option if you want the panel to play multimedia when the alarm is active or clear.
File Name		Specifies the file name of the multimedia



## 11.6. Alarm Displays

### 11.6.1. Basic Operations

There are four types of alarm displays.

Type	Description																																																																		
Alarm History	<p>You can display a list of alarm records by using an alarm history display.</p> <table border="1"> <thead> <tr> <th>Date</th> <th>Time</th> <th>Blk Id</th> <th>Level</th> <th>Id</th> <th>Status</th> <th>Message</th> </tr> </thead> <tbody> <tr> <td>03-04-09</td> <td>08:53:50</td> <td>0</td> <td>4</td> <td>L002</td> <td>C</td> <td>Tank #1 level too high</td> </tr> <tr> <td>03-04-09</td> <td>08:53:44</td> <td>0</td> <td>4</td> <td>L002</td> <td>A</td> <td>Tank #1 level too high</td> </tr> <tr> <td>03-04-09</td> <td>08:53:39</td> <td>0</td> <td>3</td> <td>T001</td> <td>C</td> <td>Tank #1 temperature too high</td> </tr> <tr> <td>03-04-09</td> <td>08:53:35</td> <td>0</td> <td>3</td> <td>T001</td> <td>ACK</td> <td>Tank #1 temperature too high</td> </tr> <tr> <td>03-04-09</td> <td>08:53:34</td> <td>0</td> <td>3</td> <td>T001</td> <td>A</td> <td>Tank #1 temperature too high</td> </tr> </tbody> </table> <p>The above is an example of the alarm history display. The first row is the title row. It displays the title of each column. The other rows display one alarm record per row. You can create scroll button groups or scroll bars to scroll the contents. An alarm history display can have seven columns. The following table describes the content of each column for an alarm record.</p> <table border="1"> <thead> <tr> <th>Column</th> <th>Description</th> </tr> </thead> <tbody> <tr> <td>Date</td> <td>The date when the record is created. This column is optional.</td> </tr> <tr> <td>Time</td> <td>The time when the record is created. This column is optional.</td> </tr> <tr> <td>Alarm Block ID</td> <td>The ID of the alarm block in which the associated alarm is defined. This column is optional.</td> </tr> <tr> <td>Alarm Level</td> <td>The level of the associated alarm. This column is optional.</td> </tr> <tr> <td>Alarm ID</td> <td>The ID of the associated alarm. This column is optional.</td> </tr> <tr> <td>Alarm Status</td> <td> <p>The type of the alarm record. There are three types of alarm records.</p> <table border="1"> <thead> <tr> <th>Type</th> <th>Description</th> </tr> </thead> <tbody> <tr> <td>Active</td> <td>An Active record is created when an alarm is activated.</td> </tr> <tr> <td>ACK</td> <td>An ACK record is created when an alarm is acknowledged.</td> </tr> <tr> <td>CLR</td> <td>A CLR record is created when an alarm is cleared.</td> </tr> </tbody> </table> </td> </tr> <tr> <td>Alarm Message</td> <td>The message of the associated alarm. This column is optional.</td> </tr> </tbody> </table> <p>The text color of a row is determined by the type of the alarm record.</p>	Date	Time	Blk Id	Level	Id	Status	Message	03-04-09	08:53:50	0	4	L002	C	Tank #1 level too high	03-04-09	08:53:44	0	4	L002	A	Tank #1 level too high	03-04-09	08:53:39	0	3	T001	C	Tank #1 temperature too high	03-04-09	08:53:35	0	3	T001	ACK	Tank #1 temperature too high	03-04-09	08:53:34	0	3	T001	A	Tank #1 temperature too high	Column	Description	Date	The date when the record is created. This column is optional.	Time	The time when the record is created. This column is optional.	Alarm Block ID	The ID of the alarm block in which the associated alarm is defined. This column is optional.	Alarm Level	The level of the associated alarm. This column is optional.	Alarm ID	The ID of the associated alarm. This column is optional.	Alarm Status	<p>The type of the alarm record. There are three types of alarm records.</p> <table border="1"> <thead> <tr> <th>Type</th> <th>Description</th> </tr> </thead> <tbody> <tr> <td>Active</td> <td>An Active record is created when an alarm is activated.</td> </tr> <tr> <td>ACK</td> <td>An ACK record is created when an alarm is acknowledged.</td> </tr> <tr> <td>CLR</td> <td>A CLR record is created when an alarm is cleared.</td> </tr> </tbody> </table>	Type	Description	Active	An Active record is created when an alarm is activated.	ACK	An ACK record is created when an alarm is acknowledged.	CLR	A CLR record is created when an alarm is cleared.	Alarm Message	The message of the associated alarm. This column is optional.
Date	Time	Blk Id	Level	Id	Status	Message																																																													
03-04-09	08:53:50	0	4	L002	C	Tank #1 level too high																																																													
03-04-09	08:53:44	0	4	L002	A	Tank #1 level too high																																																													
03-04-09	08:53:39	0	3	T001	C	Tank #1 temperature too high																																																													
03-04-09	08:53:35	0	3	T001	ACK	Tank #1 temperature too high																																																													
03-04-09	08:53:34	0	3	T001	A	Tank #1 temperature too high																																																													
Column	Description																																																																		
Date	The date when the record is created. This column is optional.																																																																		
Time	The time when the record is created. This column is optional.																																																																		
Alarm Block ID	The ID of the alarm block in which the associated alarm is defined. This column is optional.																																																																		
Alarm Level	The level of the associated alarm. This column is optional.																																																																		
Alarm ID	The ID of the associated alarm. This column is optional.																																																																		
Alarm Status	<p>The type of the alarm record. There are three types of alarm records.</p> <table border="1"> <thead> <tr> <th>Type</th> <th>Description</th> </tr> </thead> <tbody> <tr> <td>Active</td> <td>An Active record is created when an alarm is activated.</td> </tr> <tr> <td>ACK</td> <td>An ACK record is created when an alarm is acknowledged.</td> </tr> <tr> <td>CLR</td> <td>A CLR record is created when an alarm is cleared.</td> </tr> </tbody> </table>	Type	Description	Active	An Active record is created when an alarm is activated.	ACK	An ACK record is created when an alarm is acknowledged.	CLR	A CLR record is created when an alarm is cleared.																																																										
Type	Description																																																																		
Active	An Active record is created when an alarm is activated.																																																																		
ACK	An ACK record is created when an alarm is acknowledged.																																																																		
CLR	A CLR record is created when an alarm is cleared.																																																																		
Alarm Message	The message of the associated alarm. This column is optional.																																																																		

Continued



Type	Description																																		
<p>Alarm Count</p>	<p>You can display a list of the number of occurrences for each alarm by using an alarm count display.</p> <table border="1" data-bbox="288 282 1214 573"> <thead> <tr> <th>Level</th> <th>Id</th> <th>Count</th> <th>Message</th> </tr> </thead> <tbody> <tr> <td>3</td> <td>L001</td> <td>4</td> <td>Tank #1 level too high</td> </tr> <tr> <td>4</td> <td>L002</td> <td>1</td> <td>Tank #1 level too low</td> </tr> <tr> <td>3</td> <td>T001</td> <td>5</td> <td>Tank #1 temperature too high</td> </tr> <tr> <td>4</td> <td>T002</td> <td>3</td> <td>Tank #1 temperature too low</td> </tr> </tbody> </table> <p>The above is an example of an alarm count display. The first row is the title row. It displays the title of each column. The other rows display one alarm per row. You can create scroll button groups or scroll bars to scroll the contents. An alarm count display can have five columns. The following table describes the content of each column for an alarm.</p> <table border="1" data-bbox="276 707 1505 999"> <thead> <tr> <th>Column</th> <th>Description</th> </tr> </thead> <tbody> <tr> <td>Alarm Block ID</td> <td>The ID of the alarm block in which the alarm is defined. This column is optional.</td> </tr> <tr> <td>Alarm Level</td> <td>The level of the alarm. This column is optional.</td> </tr> <tr> <td>Alarm ID</td> <td>The ID of the alarm. This column is optional.</td> </tr> <tr> <td>Alarm Count</td> <td>The number of occurrences of the alarm.</td> </tr> <tr> <td>Alarm Message</td> <td>The message of the alarm. This column is optional.</td> </tr> </tbody> </table> <p>The text color of a row is determined by the level of the alarm.</p>	Level	Id	Count	Message	3	L001	4	Tank #1 level too high	4	L002	1	Tank #1 level too low	3	T001	5	Tank #1 temperature too high	4	T002	3	Tank #1 temperature too low	Column	Description	Alarm Block ID	The ID of the alarm block in which the alarm is defined. This column is optional.	Alarm Level	The level of the alarm. This column is optional.	Alarm ID	The ID of the alarm. This column is optional.	Alarm Count	The number of occurrences of the alarm.	Alarm Message	The message of the alarm. This column is optional.		
Level	Id	Count	Message																																
3	L001	4	Tank #1 level too high																																
4	L002	1	Tank #1 level too low																																
3	T001	5	Tank #1 temperature too high																																
4	T002	3	Tank #1 temperature too low																																
Column	Description																																		
Alarm Block ID	The ID of the alarm block in which the alarm is defined. This column is optional.																																		
Alarm Level	The level of the alarm. This column is optional.																																		
Alarm ID	The ID of the alarm. This column is optional.																																		
Alarm Count	The number of occurrences of the alarm.																																		
Alarm Message	The message of the alarm. This column is optional.																																		
<p>Active Alarm</p>	<p>You can display a list of active alarms by using an active alarm display.</p> <table border="1" data-bbox="288 1133 1214 1424"> <thead> <tr> <th>Date</th> <th>Time</th> <th>Id</th> <th>Message</th> </tr> </thead> <tbody> <tr> <td>03-05-09</td> <td>04:39:54</td> <td>L002</td> <td>Tank #1 level too low</td> </tr> <tr> <td>03-05-09</td> <td>04:39:51</td> <td>T001</td> <td>Tank #1 temperature too high</td> </tr> <tr> <td></td> <td></td> <td></td> <td></td> </tr> <tr> <td></td> <td></td> <td></td> <td></td> </tr> </tbody> </table> <p>The above is an example of an active alarm display. The first row is the title row. It displays the title of each column. The other rows display one active alarm per row. You can create scroll button groups or scroll bars to scroll the contents. An active alarm display can have six columns. The following table describes the content of each column for an active alarm.</p> <table border="1" data-bbox="276 1563 1505 1895"> <thead> <tr> <th>Column</th> <th>Description</th> </tr> </thead> <tbody> <tr> <td>Date</td> <td>The date when the alarm is activated.</td> </tr> <tr> <td>Time</td> <td>The time when the alarm is activated.</td> </tr> <tr> <td>Alarm Block ID</td> <td>The ID of the alarm block in which the alarm is defined. This column is optional.</td> </tr> <tr> <td>Alarm Level</td> <td>The level of the alarm. This column is optional.</td> </tr> <tr> <td>Alarm ID</td> <td>The ID of the alarm. This column is optional.</td> </tr> <tr> <td>Alarm Message</td> <td>The message of the alarm. This column is optional.</td> </tr> </tbody> </table> <p>The text color of a row is determined by the level of the alarm.</p>	Date	Time	Id	Message	03-05-09	04:39:54	L002	Tank #1 level too low	03-05-09	04:39:51	T001	Tank #1 temperature too high									Column	Description	Date	The date when the alarm is activated.	Time	The time when the alarm is activated.	Alarm Block ID	The ID of the alarm block in which the alarm is defined. This column is optional.	Alarm Level	The level of the alarm. This column is optional.	Alarm ID	The ID of the alarm. This column is optional.	Alarm Message	The message of the alarm. This column is optional.
Date	Time	Id	Message																																
03-05-09	04:39:54	L002	Tank #1 level too low																																
03-05-09	04:39:51	T001	Tank #1 temperature too high																																
Column	Description																																		
Date	The date when the alarm is activated.																																		
Time	The time when the alarm is activated.																																		
Alarm Block ID	The ID of the alarm block in which the alarm is defined. This column is optional.																																		
Alarm Level	The level of the alarm. This column is optional.																																		
Alarm ID	The ID of the alarm. This column is optional.																																		
Alarm Message	The message of the alarm. This column is optional.																																		

Continued





Type	Description								
Alarm Marquee	<p>You can display and scroll the messages of the active alarms by using an alarm marquee.</p> <div style="border: 1px solid black; padding: 5px; text-align: center;"> <p><b>4 L002 Tank #1 level too high      3 T001 Tank #1 temperature too high</b></p> </div> <p>The above is an example of an alarm marquee. You can place the following texts in front of the alarm messages.</p> <table border="1"> <thead> <tr> <th>Text</th> <th>Description</th> </tr> </thead> <tbody> <tr> <td>Alarm Block ID</td> <td>The ID of the alarm block in which the alarm is defined.</td> </tr> <tr> <td>Alarm Level</td> <td>The level of the alarm.</td> </tr> <tr> <td>Alarm ID</td> <td>The ID of the alarm.</td> </tr> </tbody> </table> <p>The text color for an alarm is determined by the level of that alarm.</p>	Text	Description	Alarm Block ID	The ID of the alarm block in which the alarm is defined.	Alarm Level	The level of the alarm.	Alarm ID	The ID of the alarm.
Text	Description								
Alarm Block ID	The ID of the alarm block in which the alarm is defined.								
Alarm Level	The level of the alarm.								
Alarm ID	The ID of the alarm.								

**Note:** You can sort the list of an alarm display at runtime by touching the title of the column that you want it to be the sort field. Touching the same title again changes the sort order from the ascending order to the descending order or vice versa. The columns that can be a sort field include: Date, Time, Alarm Block ID, Alarm Level, Alarm ID, Alarm Status, and Alarm Count.

### 11.6.2. Operation Options

The following operation option can be added to an alarm display. Select and set the option in the Alarm Display dialog box.

Options	Description
Visibility Control	You can show and hide an alarm display by a specified bit or the current user level. Select and set this option in the Visibility page.

### 11.6.3. Settings

You can complete all the settings of an alarm display in the Alarm Display dialog box. This dialog box contains the following two pages.

- **General**  
Described in [Section 11.4.3.](#)
- **Visibility**  
Described in [Section 4.4.6.](#)



### 11.6.4. General Settings

This section describes how to define the general settings for an alarm display. The following is an example of the General page of the Alarm Display dialog box.

The following table describes each property in the General page.

Property	Description
ID	The object's identifier. It is generated when the object is created. The identifier is unique within the screen where the object is on and is unchangeable. The format of the ID's for the alarm displays is AD####.
Note	You can type a note for the object.
Shape settings	For details about the following properties, see <a href="#">Section 4.3.4 Setting up the Shape of an Object.</a>  , Border Color, BG Color

Continued



Property		Description
Type	Specifies the type of the alarm display. There are four types:	
	<b>Type</b>	<b>Description</b>
	Alarm History	The alarm history display lists the alarm records.
	Alarm Count	The alarm count display lists the number of occurrences of each alarm.
	Active Alarm	The active alarm display lists the active alarms.
Alarm Marquee	The alarm marquee scrolls the messages of the active alarms horizontally.	
Scrolling Speed		Select a speed for the alarm display when the Type is Alarm Marquee.
Direction		Select Leftward or Rightward for the alarm display when the Type is Alarm Marquee.
Grid	Vertical	Select this option if you want the alarm display to have vertical grids.
	Horizontal	Select this option if you want the alarm display to have horizontal grids.
	Color	Select a color for the grids.
Alarm Block		Select an alarm block that the alarm display will show the alarms defined in that alarm block only. Select All if you want the alarm display to show all the alarms.
Title	<Check Box>	Select this option if you want the alarm display to have a title row to show the title for each column of the displayed list when the Type is Alarm History, Alarm Count, or Current Alarm.
	Language	Select a language so you can view and edit the settings of the title row for that language.
	Font	Select a font for the title text.
	Color	Select a color for the text.
	BG Color	Select a color for the title row.
	Date	Specifies the title for the Date column. This field is available when the Type is Alarm History or Current Alarm.
	Time	Specifies the title for the Time column. This field is available when the Type is Alarm History or Current Alarm.
	Alarm Block ID	Specifies the title for the Alarm Block ID column.
	Alarm Level	Specifies the title for the Alarm Level column.
	Alarm ID	Specifies the title for the Alarm ID column.
	Alarm Status	Specifies the title for the Alarm Status column. This field is available when the Type is Alarm History.
	Alarm Count	Specifies the title for the Alarm Count column. This field is available when the Type is Alarm Count.
	Alarm Message	Specifies the title for the Alarm Message column.

Continued



Property		Description	
Text	Sort Type	Specifies how the alarm display sorts its list initially. This field is available when the Type is not Alarm Marquee. <b>Note:</b> When you want an alarm display to sort its list by the contents of a column at runtime, simply touch the title of that column and the alarm display will sort its list right away.	
	Language	Select a language so you can view and edit the language dependent settings in the Text group for that language. The language dependent properties in the Text group include Font and Alarm Status Abbreviation.	
	Font	Select a font for the text.	
	Date	<Check Box>	Check this option if you want the alarm display to have the Date column. This field is available when the Type is Alarm History.
		<Drop-down List>	Select a format for displaying the date
	Time	<Check Box>	Check this option if you want the alarm display to have the Time column. This field is available when the Type is Alarm History.
		<Drop-down List>	Select a format for displaying the time
	Alarm Block ID	Check this option if you want the alarm display to have the Alarm Block ID column.	
	Alarm Level	Check this option if you want the alarm display to have the Alarm Level column.	
	Alarm ID	Check this option if you want the alarm display to have the Alarm ID column.	
	Alarm Message	Check this option if you want the alarm display to have the Alarm Message column.	
	Cleared Alarms	Check this option so the alarm display will show the records of cleared alarms. This field is available when the Type is Alarm History.	
	Alarm ACK	Check this option so the alarm display will show the records of acknowledged alarms. This field is available when the Type is Alarm History.	
	Alarm Status Abbreviation	Active	Enter up to 3 characters that will be shown in the Alarm Status column for the alarm records that record when an alarm occurs. This field is available when the Type is Alarm History.
Cleared		Enter up to 3 characters that will be shown in the Alarm Status column for the alarm records that record when an alarm is cleared. This field is available when the Type is Alarm History.	
ACK		Enter up to 3 characters that will be shown in the Alarm Status column for the alarm records that record when an alarm is acknowledged. This field is available when the Type is Alarm History.	
Line Spacing	Specifies the extra space in pixels for two adjacent rows of the alarm display. This field is available when the Type is not Alarm Marquee.		
Item Spacing	Specifies the extra space for every column of the alarm display. This field is available when the Type is not Alarm Marquee.		
Alarm Message Color		Click the button to replace the selections of the L1 to L8 fields by the default alarm message colors defined in the Alarm Properties dialog box. . This button is available when the Type is not Alarm History.	
	L1,L2 ... L8	Select a color for alarm level 1,2...8. The alarm display will show an alarm message with this color if that alarm is defined as a level 1,2...8 alarm. This field is available when the Type is not Alarm History.	
	Active	Select a color for displaying the alarm records that record when an alarm occurs. This field is available when the Type is Alarm History.	
	Cleared	Select a color for displaying the alarm records that record when an alarm is cleared. This field is available when the Type is Alarm History.	
	ACK	Select a color for displaying the alarm records that record when an alarm is acknowledged. This field is available when the Type is Alarm History.	



# CHAPTER 12

## DATA COLLECTION AND HISTORIC DISPLAYS

<b>12.1.Data Logger .....</b>	<b>1</b>
12.1.1. Settings.....	1
12.1.2. General Settings.....	2
12.1.3. Data Item Settings .....	5
<b>12.2.Displaying Logged Data Values Using Historic Data Tables .....</b>	<b>7</b>
12.2.1. Basic Operations .....	7
12.2.2. Operation Options.....	7
12.2.3. Settings.....	7
12.2.4. General Settings.....	8
12.2.5. Data Item Settings .....	10
<b>12.3.Displaying Logged Data Trend Using Historic Trend Graph.....</b>	<b>11</b>
12.3.1. Basic Operations .....	11
12.3.2. Operation Options.....	12
12.3.3. Settings.....	12
12.3.4. General Settings.....	13
12.3.5. Curve Settings .....	15
12.3.6. Axis Settings.....	16
<b>12.4.Displaying History of Predefined Events Using Historic Event Tables</b>	<b>18</b>
12.4.1. Basic Operations .....	18
12.4.2. Operation Options.....	18
12.4.3. Settings.....	19
12.4.4. General Settings.....	20
12.4.5. Message Settings .....	22
<b>12.5.Displaying Time Slice Data Profile Using Single Record Line Charts</b>	<b>23</b>
12.5.1. Basic Operations .....	23
12.5.2. Operation Options.....	24
12.5.3. Settings.....	24
12.5.4. General Settings.....	25
12.5.5. Pen Settings .....	27
12.5.6. Axis Settings.....	29



This chapter describes how to set up the data loggers for your application to collect data and how to configure the historic display objects to display the collected data.

## 12.1. Data Logger

A data logger can collect and store the values of a data block. You can specify what data block you want to log, determine the frequency of data sampling, choose the type of memory to save the logged data, and specify how to save the logged data to files.

You can create up to 16 data loggers for your application. The maximum size of the data block that can be sampled by a data logger is 128 words.

You can use function button to request the panel to clear logged data or save/load logged data (.ldf/.txt file). To know how to define a function button, please see [Section 5.4.1 Basic Operations](#) of function buttons.

To create a data logger, you may do one of the followings:

- 1) In the PM Designer's Project Manager tool window, right-click the Data Loggers node of the concerned panel application and select Add Data Logger.
- 2) In the PM Designer's menu bar, click Panel to bring up the Panel sub-menu. Click Data Logger in the Panel sub-menu to bring up the Data Logger pop-up menu. Select Add in the pop-up menu.

### 12.1.1. Settings

You can set up a data logger with the Data Logger dialog box. There are two ways to open the dialog box of a data logger:

- 1) In the PM Designer's Project Manager window, right-click the node of the desired data logger and select Properties.
- 2) In the PM Designer's menu bar, click Panel to bring up the Panel sub-menu. Click Data Logger in the Panel sub-menu to bring up the Data Logger pop-up menu. Select Properties in the pop-up menu to bring up the data logger list of the current panel application. Select the data logger in the list.

The Data Logger dialog box contains the following two pages:

- **General**

Described in [Section 12.1.2.](#)

- **Data Item**

Described in [Section 12.1.3.](#)

## 12.1.2. General Settings

Use the General page to define the general settings for a data logger. The following is an example of the General page.

The table below describes each property in the General page.

Property		Description
Name		The data logger's name. The maximum length of the name is 48 characters.
ID		The data logger's ID number. Select a number between 1 and 16. The number is unique among all data loggers of the panel application.
Use battery backed RAM		Check this option so the logging buffer of the data logger will be located in the battery backed RAM. The logged data will not be lost after power down if the battery backed RAM is used for the logging buffer. If this option is not selected, the logging buffer will be located in ordinary RAM and the data logger will clear the logging buffer whenever the target panel is powered up.
Sample Size		The size of the data to be sampled. The unit is word.
Number of Samples		Specifies the maximum number of samples that the logging buffer of the data logger can hold.
Logging Buffer Size		The size of the logging buffer. The unit is word. The formula to calculate the size is: Logging Buffer Size = Number of Samples * (Sample Size + 5)
Latest Sampled Data	Word Address	You can use the addresses shown here to refer to the latest sampled data of the data logger for configuring screen objects and writing macros.
Read Address		Specifies the variable representing the data block to be sampled. Click  to enter an address for this field. Click  to select a tag for this field. The size of the data block is specified in the Sample Size field.

Continued





Property		Description														
Sampling Method	Timed	The data logger samples data periodically at a rate specified in the Interval field. You can specify an interval between 1 second and 65535 seconds for the Interval field. For example, if you want the data logger to sample data every 5 seconds, specify 5 for the Interval field.														
	Triggered	The data logger samples data once whenever the trigger bit specified in the Trigger Bit field changes from Off to On.														
	Clocked	<p>The data logger samples data at fixed moments specified in the At Each field. There are six sets of fixed moments available for the At Each field.</p> <table border="1"> <thead> <tr> <th>At Each</th> <th>Fixed Moments</th> </tr> </thead> <tbody> <tr> <td>1x</td> <td>Every minute at 0 second</td> </tr> <tr> <td>5x</td> <td>The following moments of every hour: 00:00, 05:00, 10:00, 15:00, 20:00, 25:00, 30:00, 35:00, 40:00, 45:00, 50:00, 55:00</td> </tr> <tr> <td>10x</td> <td>The following moments of every hour: 00:00, 10:00, 20:00, 30:00, 40:00, 50:00</td> </tr> <tr> <td>15x</td> <td>The following moments of every hour: 00:00, 15:00, 30:00, 45:00</td> </tr> <tr> <td>30x</td> <td>The following moments of every hour: 00:00, 30:00</td> </tr> <tr> <td>60x</td> <td>Every hour on the hour</td> </tr> </tbody> </table>	At Each	Fixed Moments	1x	Every minute at 0 second	5x	The following moments of every hour: 00:00, 05:00, 10:00, 15:00, 20:00, 25:00, 30:00, 35:00, 40:00, 45:00, 50:00, 55:00	10x	The following moments of every hour: 00:00, 10:00, 20:00, 30:00, 40:00, 50:00	15x	The following moments of every hour: 00:00, 15:00, 30:00, 45:00	30x	The following moments of every hour: 00:00, 30:00	60x	Every hour on the hour
			At Each	Fixed Moments												
			1x	Every minute at 0 second												
			5x	The following moments of every hour: 00:00, 05:00, 10:00, 15:00, 20:00, 25:00, 30:00, 35:00, 40:00, 45:00, 50:00, 55:00												
10x			The following moments of every hour: 00:00, 10:00, 20:00, 30:00, 40:00, 50:00													
15x			The following moments of every hour: 00:00, 15:00, 30:00, 45:00													
30x	The following moments of every hour: 00:00, 30:00															
60x	Every hour on the hour															
Timed (sub-second)	<p>The data logger samples data periodically at a rate specified in the Interval field. You can select an interval between 0.1 second and 0.9 second for the Interval field. For example, if you want the data logger to sample data every 0.5 second, select 0.5 for the Interval field.</p> <p>The sub-second sampling requires high data acquisition performance. As there are many factors that can affect the performance, it is not guaranteed that the specified sampling rate can be attained.</p>															
Load from .LDF File	The data logger does not sample data. It receives the data loaded from an LDF file.															
Sample Full Processing	Stop Sampling	Check the option if you want the data logger to stop sampling data when the logging buffer is full.														
	Notify	Check the option if you want the data logger to set the bit specified in the Bit field to On when the number of collected samples exceeds the limit specified in the Full Limit field.														
	Bit	Available when the Notify field is checked. Specifies the bit for the sample full notification. Click  to enter an address for this field. Click  to select a tag for this field.														
	Full Limit	Available when the Notify field is checked. Select a percentage as the full limit. When the ratio of collected samples to the maximum samples specified in the Number of Samples field exceeds the percentage, the data logger sets the bit specified in the Bit field to On.														
External Control	Clear Buffer	Check this option so the data logger can be controlled to clear its logging buffer by the trigger bit specified in the Trigger Bit field.														
	Trigger Bit	Available when the Clear Buffer option is checked. Select a trigger bit that will control the data logger to clear its logging buffer. The data logger clears its logging buffer when the trigger bit changes from Off to On.														
	Enable Sampling	Check this option so the data logger can be enabled and disabled by the enabling bit specified in the Enabling Bit field.														
	Enabling Bit	Available when the Enable Sampling option is checked. Select an enabling bit that will enable and disable the data logger. The data logger is enabled when the enabling bit is On.														

Continued





Property		Description															
Save Data to File	Save Data to File	Check this option so the data logger will write the newly collected data to a specified file periodically. Each time when the data logger performs this operation, it writes only the data that are not saved to a file before.															
	File Type	<p>The type of file to save the logged data.</p> <table border="1"> <thead> <tr> <th>File Type</th> <th>Description</th> </tr> </thead> <tbody> <tr> <td>.TXT</td> <td>The logged data are saved in text format. You can use any text editor to view the logged data. Most importantly you can use Microsoft Excel to import the logged data from such files directly.</td> </tr> <tr> <td>.LDF</td> <td>The logged data are saved in a binary format than can only be used by a data logger that has exactly the same data definition. This file type allows you to view and operate historic data loaded from files.</td> </tr> </tbody> </table>	File Type	Description	.TXT	The logged data are saved in text format. You can use any text editor to view the logged data. Most importantly you can use Microsoft Excel to import the logged data from such files directly.	.LDF	The logged data are saved in a binary format than can only be used by a data logger that has exactly the same data definition. This file type allows you to view and operate historic data loaded from files.									
File Type	Description																
.TXT	The logged data are saved in text format. You can use any text editor to view the logged data. Most importantly you can use Microsoft Excel to import the logged data from such files directly.																
.LDF	The logged data are saved in a binary format than can only be used by a data logger that has exactly the same data definition. This file type allows you to view and operate historic data loaded from files.																
Operation Type	Specifies how to open a file to save the logged data.																
	<table border="1"> <thead> <tr> <th>Operation Type</th> <th>Description</th> </tr> </thead> <tbody> <tr> <td>Create</td> <td>Creates a new file with the specified filename to save the logged data.</td> </tr> <tr> <td>Append or Create</td> <td>If the specified file exists, appends the logged data to that file; otherwise creates a new file with the specified filename to save the logged data.</td> </tr> </tbody> </table>		Operation Type	Description	Create	Creates a new file with the specified filename to save the logged data.	Append or Create	If the specified file exists, appends the logged data to that file; otherwise creates a new file with the specified filename to save the logged data.									
	Operation Type	Description															
Create	Creates a new file with the specified filename to save the logged data.																
Append or Create	If the specified file exists, appends the logged data to that file; otherwise creates a new file with the specified filename to save the logged data.																
Time to Save	Specifies the period to save the logged data. There are nine kinds of period available:																
	<table border="1"> <thead> <tr> <th>Available Period</th> </tr> </thead> <tbody> <tr> <td>Every hour on the hour</td> </tr> <tr> <td>Every 8 hours (00:00, 08:00, 16:00)</td> </tr> <tr> <td>Every 12 hours (00:00, 12:00)</td> </tr> <tr> <td>Every day at 00:00</td> </tr> <tr> <td>Every day at 08:00</td> </tr> <tr> <td>Every day at 12:00</td> </tr> <tr> <td>Every Sunday at 00:00</td> </tr> <tr> <td>Every Monday at 00:00</td> </tr> <tr> <td>Every month's first day at 00:00</td> </tr> </tbody> </table>		Available Period	Every hour on the hour	Every 8 hours (00:00, 08:00, 16:00)	Every 12 hours (00:00, 12:00)	Every day at 00:00	Every day at 08:00	Every day at 12:00	Every Sunday at 00:00	Every Monday at 00:00	Every month's first day at 00:00					
	Available Period																
	Every hour on the hour																
	Every 8 hours (00:00, 08:00, 16:00)																
	Every 12 hours (00:00, 12:00)																
	Every day at 00:00																
	Every day at 08:00																
	Every day at 12:00																
	Every Sunday at 00:00																
Every Monday at 00:00																	
Every month's first day at 00:00																	
Filename	The filename or the prefix of the filename of the file to save the logged data. The extension name must be ".txt" when the File Type is ".TXT". The extension name must be ".ldf" when the File Type is ".LDF".																
Filename Suffix	Available when the Operation Type is Create. This property guarantees that the created file has a unique name and no existing file will be overwritten. There are four kinds of filename suffix available as shown in the following table.																
	<table border="1"> <thead> <tr> <th>Filename Suffix</th> <th>Description</th> <th>Example</th> </tr> </thead> <tbody> <tr> <td>_YYMMDD_hhmmss</td> <td>YY: year (00~99) MM: month (01~12) DD: day (01~31) hh: hour (00~23) mm: minute (00~59) ss: second (00~59)</td> <td>Log_090423_102358 (Assume that the specified Filename is "Log", the current date is April 23, 2009, and the current time is 10:23:58.)</td> </tr> <tr> <td>_YYMMDD_hhmm</td> <td>See above</td> <td>Log_090423_1023</td> </tr> <tr> <td>_YYMMDD_hh</td> <td>See above</td> <td>Log_090423_10</td> </tr> <tr> <td>_YYMMDD</td> <td>See above</td> <td>Log_090423</td> </tr> </tbody> </table>		Filename Suffix	Description	Example	_YYMMDD_hhmmss	YY: year (00~99) MM: month (01~12) DD: day (01~31) hh: hour (00~23) mm: minute (00~59) ss: second (00~59)	Log_090423_102358 (Assume that the specified Filename is "Log", the current date is April 23, 2009, and the current time is 10:23:58.)	_YYMMDD_hhmm	See above	Log_090423_1023	_YYMMDD_hh	See above	Log_090423_10	_YYMMDD	See above	Log_090423
	Filename Suffix	Description	Example														
	_YYMMDD_hhmmss	YY: year (00~99) MM: month (01~12) DD: day (01~31) hh: hour (00~23) mm: minute (00~59) ss: second (00~59)	Log_090423_102358 (Assume that the specified Filename is "Log", the current date is April 23, 2009, and the current time is 10:23:58.)														
	_YYMMDD_hhmm	See above	Log_090423_1023														
	_YYMMDD_hh	See above	Log_090423_10														
_YYMMDD	See above	Log_090423															



### 12.1.3. Data Item Settings

Use the Data Item page to define the data items of the sampled data for a data logger. The following is an example of the Data Item page.

Addr.	Name
L2:0	Name
L2:5	T1
L2:6	T2
L2:7	L1
L2:8	L2
L2:9	P1

Alt+Up: Move item up    Alt+Down: Move item down

Address: L2:9  
 Name: P1  
 Language: Language 1  
 Data Type: 16-Bit Unsigned Integer  
 Display Type: 16-Bit Unsigned Decimal  
 Total Digits: 5  
 Fractional Digits: 2  
 Scaling  
 Gain: 0.32  
 Offset: 0

OK    Cancel    Help

The Data Item page contains two parts. The left part is the data item list that shows the address and name of each data item in a row. The right part shows the properties of the selected data item. To select a data item, click the row of that data item in the data item list. The following table describes each property of the data item.

Property	Description
Address	You can use the address shown here to refer to the latest sampled value of the data item.
Name	Specifies the name of the data item for the language specified in the Language field.
Language	Select a language so you can view and edit the name of the data item for that language.
Data Type	The data type of the data item. The supported data types include: 16-Bit Unsigned Integer, 32-Bit Unsigned Integer, 16-Bit Signed Integer, 32-Bit Signed Integer, 16-Bit BCD, 32-Bit BCD, 32-Bit Floating Point, ASCII String, and Unicode String. Note that Unicode String is supported for PanelExpress only.

Continued



Property	Description																									
Display Type	<p>The display type for the value of the data item. The following table shows the available display types for each data type.</p> <table border="1"> <thead> <tr> <th>Data Type</th> <th>Available Display Types</th> </tr> </thead> <tbody> <tr> <td>16-Bit Unsigned Integer</td> <td>16-Bit Unsigned Decimal, 16-Bit Hexadecimal, 16-Bit Octal</td> </tr> <tr> <td>32-Bit Unsigned Integer</td> <td>32-Bit Unsigned Decimal, 32-Bit Hexadecimal, 32-Bit Octal</td> </tr> <tr> <td>16-Bit Signed Integer</td> <td>16-Bit Signed Decimal</td> </tr> <tr> <td>32-Bit Signed Integer</td> <td>32-Bit Signed Decimal</td> </tr> <tr> <td>16-Bit BCD</td> <td>16-Bit Unsigned Decimal</td> </tr> <tr> <td>32-Bit BCD</td> <td>32-Bit Unsigned Decimal</td> </tr> <tr> <td>32-Bit Floating Point</td> <td>32-Bit Floating Point</td> </tr> <tr> <td>ASCII String</td> <td>ASCII String</td> </tr> <tr> <td>Unicode String</td> <td>Unicode String</td> </tr> </tbody> </table>	Data Type	Available Display Types	16-Bit Unsigned Integer	16-Bit Unsigned Decimal, 16-Bit Hexadecimal, 16-Bit Octal	32-Bit Unsigned Integer	32-Bit Unsigned Decimal, 32-Bit Hexadecimal, 32-Bit Octal	16-Bit Signed Integer	16-Bit Signed Decimal	32-Bit Signed Integer	32-Bit Signed Decimal	16-Bit BCD	16-Bit Unsigned Decimal	32-Bit BCD	32-Bit Unsigned Decimal	32-Bit Floating Point	32-Bit Floating Point	ASCII String	ASCII String	Unicode String	Unicode String					
Data Type	Available Display Types																									
16-Bit Unsigned Integer	16-Bit Unsigned Decimal, 16-Bit Hexadecimal, 16-Bit Octal																									
32-Bit Unsigned Integer	32-Bit Unsigned Decimal, 32-Bit Hexadecimal, 32-Bit Octal																									
16-Bit Signed Integer	16-Bit Signed Decimal																									
32-Bit Signed Integer	32-Bit Signed Decimal																									
16-Bit BCD	16-Bit Unsigned Decimal																									
32-Bit BCD	32-Bit Unsigned Decimal																									
32-Bit Floating Point	32-Bit Floating Point																									
ASCII String	ASCII String																									
Unicode String	Unicode String																									
Total Digits	Specifies the number of digits to be displayed for the value of the data item.																									
Fractional Digits	<p>Specifies how to display the fractional part for the value of the data item. When the Display Type is 32-bit Floating Point, this property specifies the number of fractional digits to be displayed. When the Display Type is not 32-bit Floating Point, this property specifies not only the number of fractional digits to be displayed but also the number of least significant digits to be displayed as the fractional part. With this feature, an integer can be shown as a fixed point number.</p> <p><b>Example:</b></p> <table border="1"> <thead> <tr> <th>Display Type</th> <th>Total Digits</th> <th>Fractional Digits</th> <th>Sampled Value</th> <th>Displayed Value</th> </tr> </thead> <tbody> <tr> <td>32-bit Floating Point</td> <td>4</td> <td>2</td> <td>12.34</td> <td>12.34</td> </tr> <tr> <td>32-bit Floating Point</td> <td>4</td> <td>2</td> <td>123.4</td> <td>23.40</td> </tr> <tr> <td>16-bit Signed Decimal</td> <td>5</td> <td>2</td> <td>12345</td> <td>123.45</td> </tr> <tr> <td>16-bit Signed Decimal</td> <td>5</td> <td>2</td> <td>-5</td> <td>-0.05</td> </tr> </tbody> </table>	Display Type	Total Digits	Fractional Digits	Sampled Value	Displayed Value	32-bit Floating Point	4	2	12.34	12.34	32-bit Floating Point	4	2	123.4	23.40	16-bit Signed Decimal	5	2	12345	123.45	16-bit Signed Decimal	5	2	-5	-0.05
Display Type	Total Digits	Fractional Digits	Sampled Value	Displayed Value																						
32-bit Floating Point	4	2	12.34	12.34																						
32-bit Floating Point	4	2	123.4	23.40																						
16-bit Signed Decimal	5	2	12345	123.45																						
16-bit Signed Decimal	5	2	-5	-0.05																						
Scaling	<p>Check this option if you want the value of the data item to be displayed in a scaled manner. The following is the scaling formula:</p> $\text{DisplayedValue} = \text{SampledValue} * \text{Gain} + \text{Offset}$ <p><b>Note:</b> The <i>Gain</i> and <i>Offset</i> are 32-bit floating point numbers. They have at most 6 significant digits. The rounding and truncation errors may happen.</p>																									
Gain	Available when the Scaling option is checked. Specifies the <i>Gain</i> used in the scaling formula.																									
Offset	Available when the Scaling option is checked. Specifies the <i>Offset</i> used in the scaling formula.																									



## 12.2. Displaying Logged Data Values Using Historic Data Tables

### 12.2.1. Basic Operations

Use the following steps to create a historic data table:

- 1) Click Historic Data Table icon in the Object toolbar, or select Historic Data Table in the Object sub-menu.
- 2) Move the cursor to the screen on which you want to create the object.
- 3) Click at the desired position on the screen to place the new object.

You can use a historic data table to list the values of the data collected by a data logger.

Date	Time	T1	T2	T3	P1	P2	P3	V1	V2	V3
05/03/09	08:51:39	344.9	379.4	69.0	215.8	163.2	152.7	126.4	115.8	100.0
05/03/09	08:51:34	931.3	1000.3	931.3	236.9	221.1	200.0	184.2	163.2	173.7
05/03/09	08:51:29	931.3	1000.3	1414.2	336.9	310.5	284.2	284.2	289.5	305.3
05/03/09	08:51:24	1655.6	1931.6	1517.7	352.6	336.9	315.8	321.1	321.1	315.8
05/03/09	08:51:19	1414.2	1655.6	1241.7	321.1	247.4	242.1	231.6	231.6	242.1
05/03/09	08:51:14	1241.7	1241.7	1034.8	268.4	247.4	221.1	200.0	194.8	179.0
05/03/09	08:51:09	896.8	931.3	896.8	247.4	215.8	200.0	179.0	168.5	179.0
05/03/09	08:51:04	655.3	724.3	758.8	210.6	210.6	179.0	184.2	173.7	173.7

The above is an example of the historic data table. The first row is the title row. It displays the title of each column. The other rows display one data record per row. You can create scroll button groups or scroll bars to scroll the contents. The titles of data columns are the names of data items defined in the Data Item page of the Data Logger dialog box.

### 12.2.2. Operation Options

The following operation option can be added to a historic data table. Select and set the option in the Historic Data Table dialog box.

Options	Description
Visibility Control	You can show and hide a historic data table by a specified bit or the current user level. Select and set this option in the Visibility page.

### 12.2.3. Settings

You can set up a historic data table with the Historic Data Table dialog box. There are three ways to open the dialog box of an object:

- 1) Double-click the object.
- 2) Right-click the object to bring up the Object pop-up menu. Select Properties in the pop-up menu.
- 3) In the Object List window, double-click the row that shows the information of the object.

You can complete all the settings of a historic data table in the Historic Data Table dialog box. This dialog box contains the following three pages.

- **General**

Described in [Section 12.2.4.](#)

- **Data Item**

Described in [Section 12.2.5.](#)

- **Visibility**

Described in [Section 4.4.6.](#)

### 12.2.4. General Settings

This section describes how to define the general settings for a historic data table. The following is an example of the General page.

The screenshot shows the 'Historic Data Table' dialog box with the 'General' tab selected. The dialog has three tabs: 'General', 'Data Item', and 'Visibility'. The 'General' tab contains the following settings:

- ID:** HCD00000
- Note:** (empty text box)
- Shape...:** (button)
- Border Color:** (color picker)
- BG Color:** (color picker)
- Data Logger:** DL #0 (0) (dropdown menu)
- Title:** (checked checkbox)
- Language:** Language 1 (dropdown menu)
- Font:** Font\_2 (dropdown menu)
- Color:** (black color picker)
- Date:** Date (text box)
- Time:** Time (text box)
- Background Color:** (yellow color picker)
- Data:** (group box)
  - Font:** Font\_1 (dropdown menu)
  - Default Color:** (black color picker)
  - Set Default Color To All Data Items:** (button)
- Time/Date Display:** (group box)
  - Date:** (checked checkbox) DD/MM/YY (dropdown menu)
  - Time:** (checked checkbox) HH:MM (dropdown menu)
  - Color:** (black color picker)
- Grid:** (group box)
  - Horizontal:** (checked checkbox)
  - Vertical:** (checked checkbox)
  - Color:** (teal color picker)
- Line Spacing:** 2 (spin box)
- Item Spacing:** 2 (spin box)

At the bottom of the dialog are three buttons: 'OK', 'Cancel', and 'Help'.

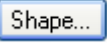

The following table describes each property in the General page.

Property		Description
ID		The object's identifier. It is generated when the object is created and is unchangeable. The identifier is unique within the screen where the object is on. The format of the ID's for the historic data tables is HDDnnnn.
Note		You can type a note for the object.
Shape settings		For details about the following properties, <a href="#">Section 4.3.4 Setting up the Shape of an Object</a> ,  , Border Color, BG Color
Data Logger		Select the data logger whose collected data is to be displayed by the object.
Title	Title	Select this option if you want the object to display a title row.
	Language	Select a language so you can view and edit the settings of the title row for that language.
	Font	Select a font for the title text.
	Color	Select a color for the title text.
	Date	Specifies the title for the Date column.
	Time	Specifies the title for the Time column.
	Background Color	Select a color for the background of the title row.
Grid	Vertical	Check this option if you want the object to have vertical grids.
	Horizontal	Check this option if you want the object to have horizontal grids.
	Color	Select a color for the grids.
Data	Font	Select a font for displaying data.
	Default Color	Select a color as the default color for displaying data.
	Set Default Color to All Data Items	Click this button to set the colors of all the data items to the Default Color.
Time/Date Display	Date	Check this option if you want the object to display the Date column. You need to select a format for displaying the date.
	Time	Check this option if you want the object to display the Time column. You need to select a format for displaying the time.
Line Spacing		Specifies the extra space in pixels for two adjacent rows in the table.
Item Spacing		Specifies the extra space for every column in the table.

## 12.2.5. Data Item Settings

This section describes how to define the display format for the sampled values of each data item. The following is an example of the Data Item page.

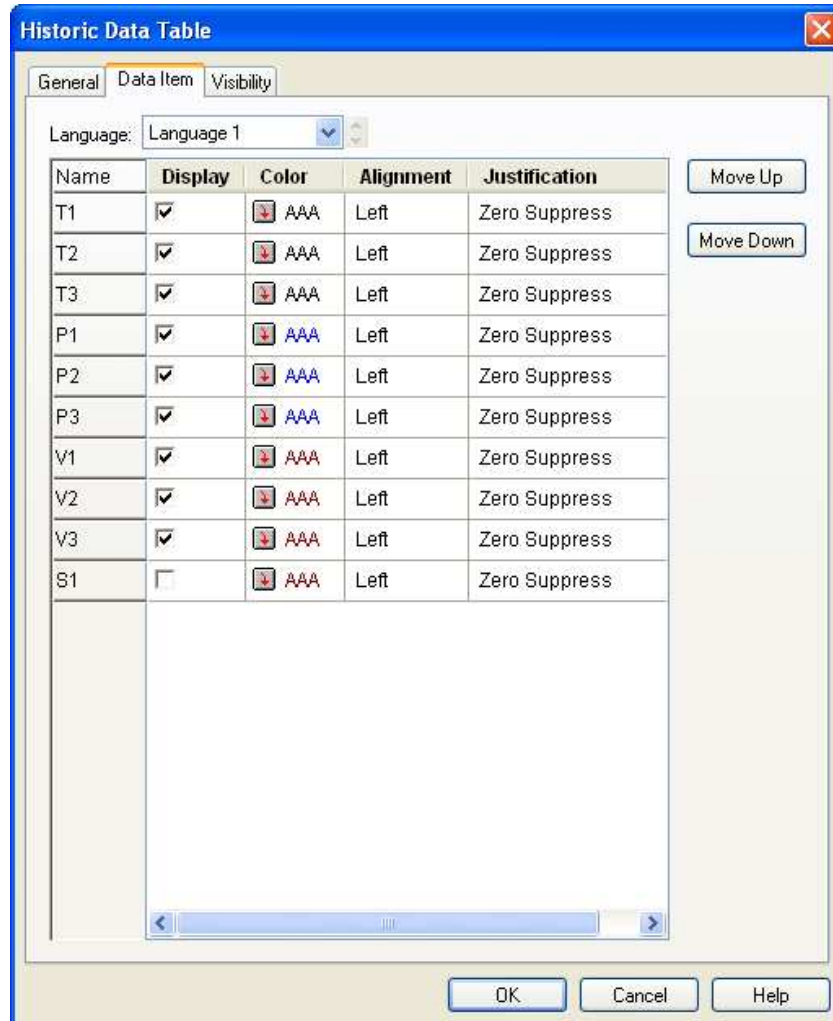

The following table describes each property in the Data Item page.

Property		Description							
Language		Select a language so you can view and edit the settings for that language.							
Row #n of the property table	Name	The name of data item #n. The data item names are defined in the Data Item page of the Data Logger dialog box.							
	Display	Check this option if you want the object to display data item #n.							
	Color	Select a color for displaying data item #n.							
	Alignment	The alignment for displaying data item #n. There are three types of alignment: Left, Center, and Right.							
	Justification	The justification for displaying data item #n. There are three types of justification: <table border="1" data-bbox="411 1787 1497 1960"> <thead> <tr> <th>Option</th> <th>Description</th> </tr> </thead> <tbody> <tr> <td>Zero Suppress</td> <td>The leading digits will not display when they are 0.</td> </tr> <tr> <td>Leading Zeros</td> <td>All digits will display.</td> </tr> <tr> <td>Leading Spaces</td> <td>The leading digits will display as blank character when they are 0.</td> </tr> </tbody> </table>	Option	Description	Zero Suppress	The leading digits will not display when they are 0.	Leading Zeros	All digits will display.	Leading Spaces
Option	Description								
Zero Suppress	The leading digits will not display when they are 0.								
Leading Zeros	All digits will display.								
Leading Spaces	The leading digits will display as blank character when they are 0.								



## 12.3. Displaying Logged Data Trend Using Historic Trend Graph

### 12.3.1. Basic Operations

Follow the steps below to create a historic trend graph:

- 1) Click Historic Trend Graph icon in the Object toolbar, or select Historic Trend Graph in the Object sub-menu.
- 2) Move the cursor to the screen on which you want to create the object.
- 3) Click at the desired position on the screen to place the new object.

You can use a Historic Trend Graph to display the values of the data collected by a data logger as a trend graph.

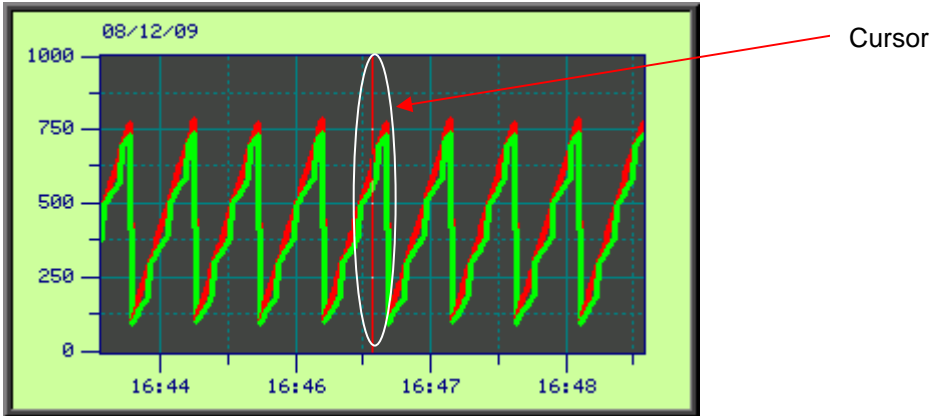

A historic trend graph can display up to 16 curves. The above is an example of the historic trend graph with two curves. A historic trend graph can provide a cursor for you to estimate the value in the desired time





### 12.3.2. Operation Options

The following operation option can be added to a historic trend graph. Select and set the option in the Historic Trend Graph dialog box.

Options	Description
Visibility Control	You can show and hide a historic trend graph by a specified bit or the current user level. Select and set this option in the Visibility page.

### 12.3.3. Settings

You can set up a historic trend graph with the Historic Trend Graph dialog box. There are three ways to open the dialog box of an object:

- 1) Double-click the object.
- 2) Right-click the object to bring up the Object pop-up menu. Select Properties in the pop-up menu.
- 3) In the Object List window, double-click the row that shows the information of the object.

The Historic Trend Graph dialog box contains the following four pages:

- **General**

Described in [Section 12.3.4.](#)

- **Curve**

Described in [Section 12.3.5.](#)

- **Axis**

Described in [Section 12.3.6.](#)

- **Visibility**

Described in [Section 4.4.6.](#)



### 12.3.4. General Settings

This section describes how to define the general settings for a historic trend graph. The following is an example of the General page of the Historic Trend Graph property sheet.

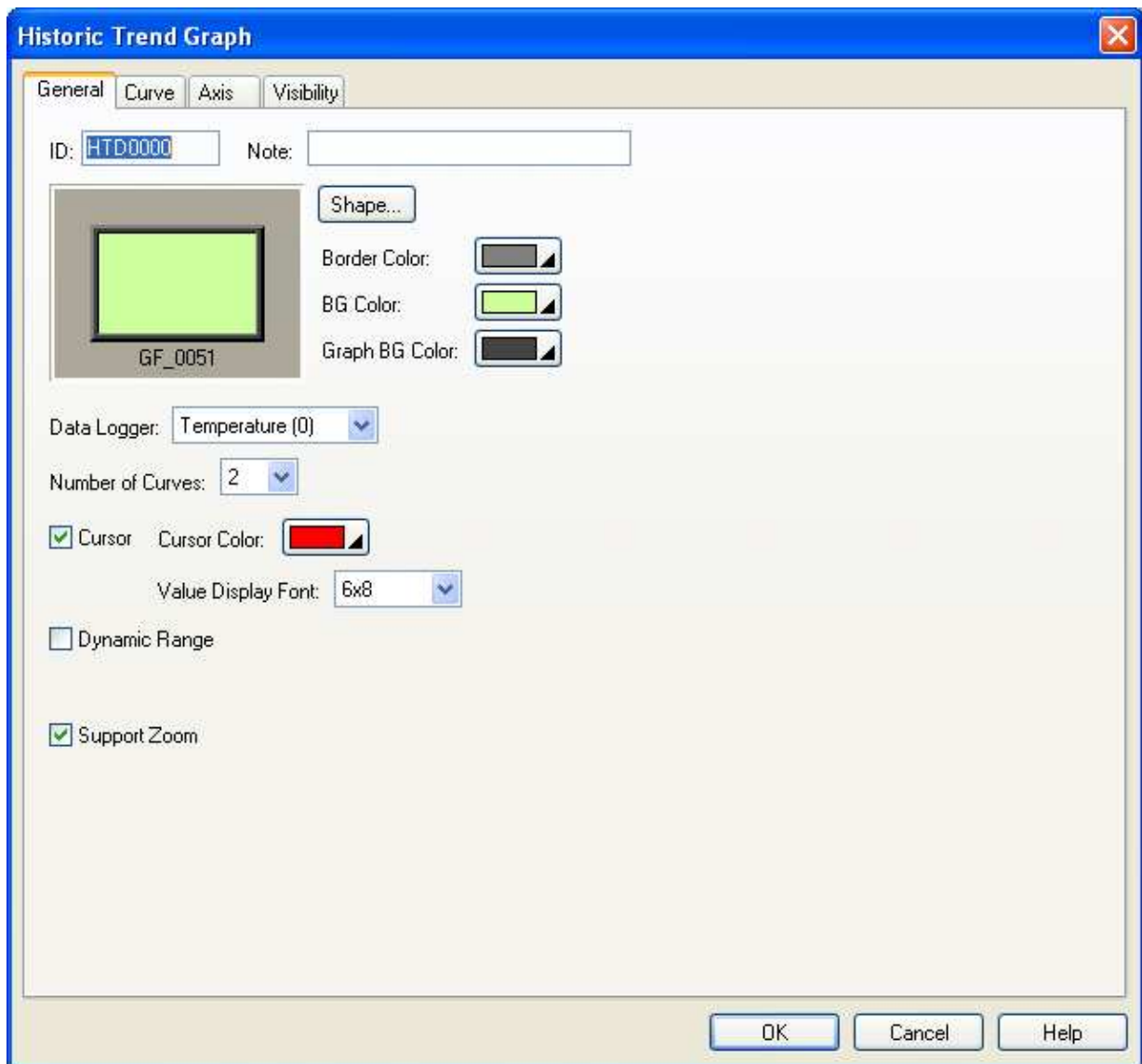



The following table describes each property in the General page.

Property	Description
ID	The object's identifier. It is generated when the object is created and is unchangeable. The identifier is unique within the screen where the object is on. The format of the ID's for the historic trend graph is HTDnnnn.
Note	You can type a note for the object.
Shape settings	For details about the following properties, see <a href="#">Section 4.3.4 Setting up the Shape of an Object</a> . <a href="#">Shape...</a> , Border Color, BG Color.
Graph BG color	Select a color for the background of the graph.
Data Logger	Specifies the associated data logger.
Number of Curves	Specifies the number of curves.

Continued



Property		Description																					
Cursor	<Check box>	Check this option so the historic trend graph will display a cursor. You can touch and drag the cursor to the data point(s) that you want to select.																					
	Cursor Color	Select a color for the cursor.																					
	Value Display Font	Select a font for displaying the values of the selected data point(s).																					
Dynamic Range	Dynamic Range	<p>When this option is selected, the following three ranges can be specified at runtime:</p> <ul style="list-style-type: none"> <li>• The minimum and the maximum for the Y values of each curve</li> <li>• The maximum time duration for X axis</li> <li>• The minimum and maximum of the marks for the Y axis</li> </ul> <p>The data that specifies the above three ranges should be set and arranged correctly in a memory block called the dynamic range parameter block. You need to specify the dynamic range parameter block in the Dynamic Range Parameter Block field.</p>																					
	Dynamic Range Parameter Block	<p>Specifies the variable that stores the dynamic range parameter block for the historic trend graph when the Dynamic Range is selected.</p> <p>Click  to enter an address for this field. Click  to select a tag for this field. The following table shows the data arrangement of the parameter block.</p> <table border="1"> <thead> <tr> <th>Word</th> <th>Description</th> </tr> </thead> <tbody> <tr> <td>0,1</td> <td>The maximum time duration for X axis</td> </tr> <tr> <td>6,7</td> <td>The minimum of the mark for the Y axis</td> </tr> <tr> <td>8,9</td> <td>The maximum of the mark for the Y axis</td> </tr> <tr> <td>10,11</td> <td>The minimum of Y values for curve #1</td> </tr> <tr> <td>12,13</td> <td>The maximum of Y values for curve #1</td> </tr> <tr> <td>14,15</td> <td>The minimum of Y values for curve #2</td> </tr> <tr> <td>16,17</td> <td>The maximum of Y values for curve #2</td> </tr> <tr> <td>...</td> <td>...</td> </tr> <tr> <td>70,71</td> <td>The minimum of Y values for curve #16</td> </tr> <tr> <td>72,73</td> <td>The maximum of Y values for curve #16</td> </tr> </tbody> </table>	Word	Description	0,1	The maximum time duration for X axis	6,7	The minimum of the mark for the Y axis	8,9	The maximum of the mark for the Y axis	10,11	The minimum of Y values for curve #1	12,13	The maximum of Y values for curve #1	14,15	The minimum of Y values for curve #2	16,17	The maximum of Y values for curve #2	...	...	70,71	The minimum of Y values for curve #16	72,73
Word	Description																						
0,1	The maximum time duration for X axis																						
6,7	The minimum of the mark for the Y axis																						
8,9	The maximum of the mark for the Y axis																						
10,11	The minimum of Y values for curve #1																						
12,13	The maximum of Y values for curve #1																						
14,15	The minimum of Y values for curve #2																						
16,17	The maximum of Y values for curve #2																						
...	...																						
70,71	The minimum of Y values for curve #16																						
72,73	The maximum of Y values for curve #16																						
Support Zoom		Check this option so zoom option will be supported at the runtime. You may use the function button to zoom in or zoom out the historic trend graph at the runtime. This field is available only when the Dynamic Range field is not checked.																					



### 12.3.5. Curve Settings

This section describes how to define the pens for the historic trend graph. The following is an example of the Pen page.

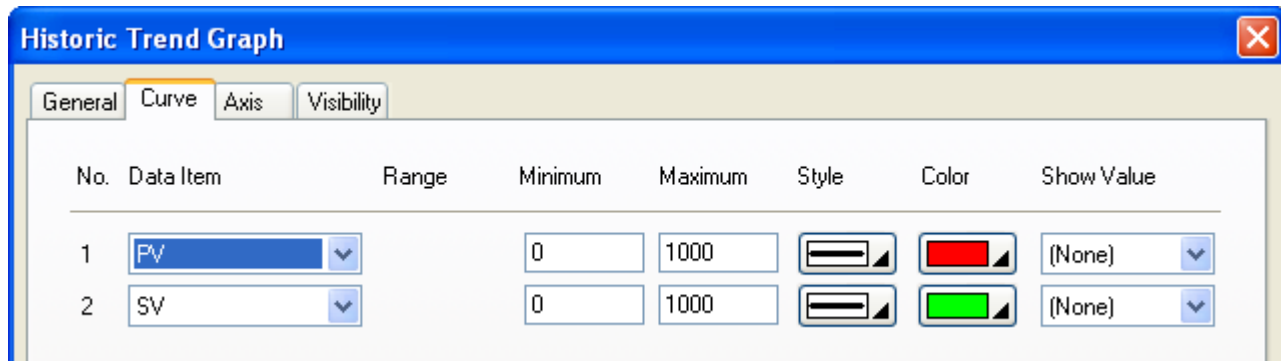

The following table describes each property in the Curve page.

Property	Description								
Data Item	Select a data item in the associated data logger for the curve.								
Range	Check this option so the minimum and the maximum for the Y values of the associated curve will be specified at runtime. This option is available only when the Dynamic Range option in the General page is checked.								
Minimum	The Y minimum of the data value of the associated curve. This property is available when the Dynamic Range option is not selected.								
Maximum	The Y maximum of the data value of the associated curve. This property is available when the Dynamic Range option is not selected.								
Style	Select a style for the trending curve.								
Color	Select a color for the trending curve.								
Show Value	Select one of the following methods for displaying the selected data point value. <table border="1"> <thead> <tr> <th>Show Value</th> <th>Description</th> </tr> </thead> <tbody> <tr> <td>(None)</td> <td>Does not display the data point value.</td> </tr> <tr> <td>Original</td> <td>Displays the data point value without modification.</td> </tr> <tr> <td>Scaled</td> <td>Displays the corresponding Y axis value of the data point.</td> </tr> </tbody> </table>	Show Value	Description	(None)	Does not display the data point value.	Original	Displays the data point value without modification.	Scaled	Displays the corresponding Y axis value of the data point.
Show Value	Description								
(None)	Does not display the data point value.								
Original	Displays the data point value without modification.								
Scaled	Displays the corresponding Y axis value of the data point.								

### 12.3.6. Axis Settings

This section describes how to define the Time axis (X axis) and the Y axis for the historic trend graph.

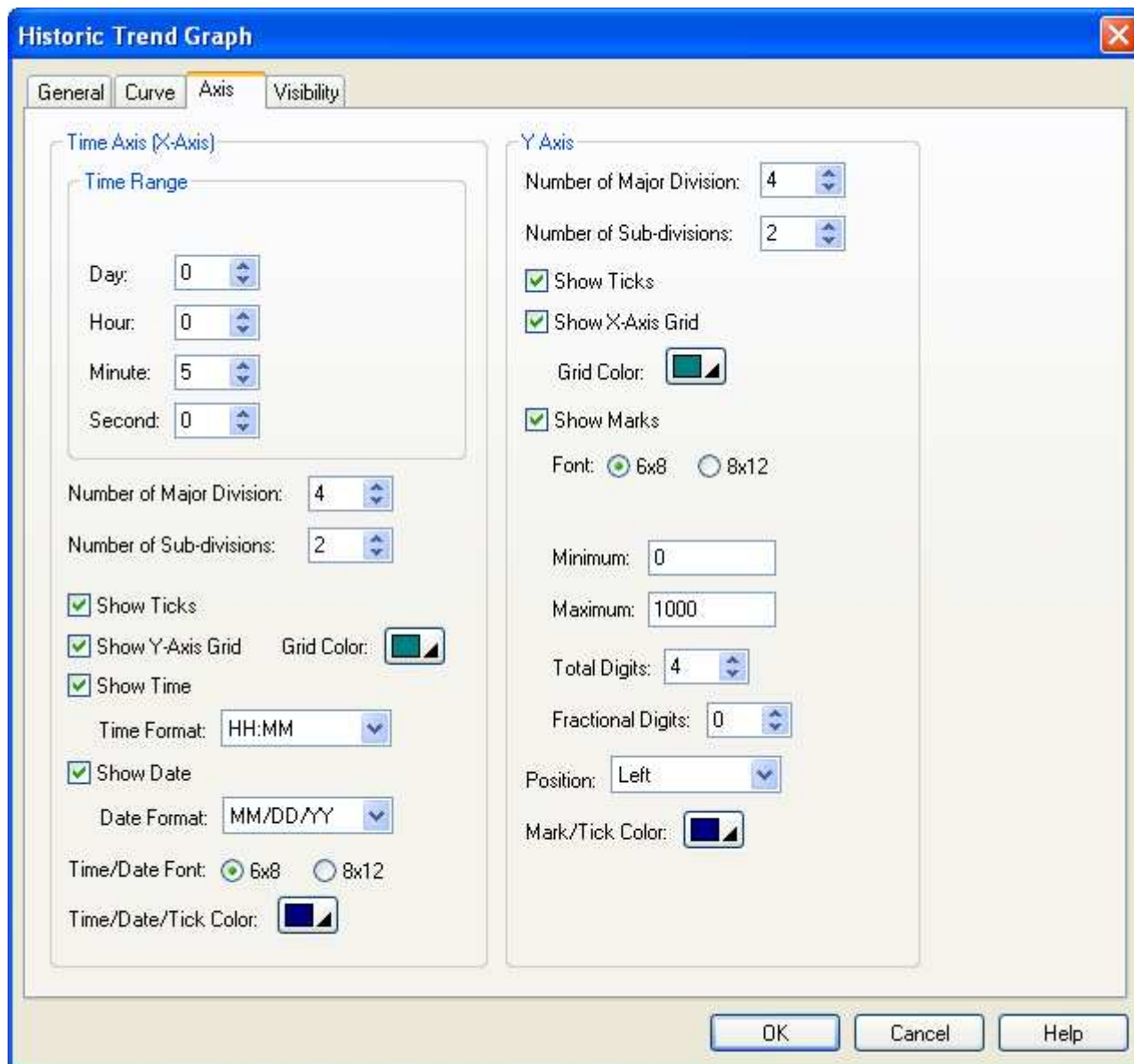

The following table describes each property in the Axis page.

Property		Description
Time Axis (X Axis) – Time Range	Dynamic Range	Check this option if you want the maximum time duration to be controlled by the dynamic range parameter block of the associated object at runtime. This option is available only when the Dynamic Range option in the General page is checked.
	Unit	Select a unit for dynamic range. The field is only available when the Dynamic Range is checked.
	Day/Hour/Minute/Second	If the Dynamic Range is not checked in both general page and axis page, you need specify maximum time duration.

Continued



Time Axis (X Axis)	Number of Major Divisions	The number of major divisions for the X axis. The minimum you can specify is one.						
	Number of Sub-divisions	The number of divisions between two adjacent major ticks. The minimum you can specify is one.						
	Show Ticks	Check this option if you want the X axis to have ticks.						
	Show Y-axis Grid	Select this option if you want the X axis to have vertical grids.						
	Grid Color	Select a color for the vertical grids.						
	Show Time	Check this option if you want to display time. You need to select a format for displaying the time.						
	Time Format	The format of how the time is displayed. There are two kinds of format available. <table border="1" data-bbox="528 607 1453 763"> <thead> <tr> <th>Format</th> <th>Description</th> </tr> </thead> <tbody> <tr> <td>HH:MM</td> <td>HH: 00~23 (hour); MM: 00~59 (minute)</td> </tr> <tr> <td>HH:MM:SS</td> <td>HH: 00~23 (hour); MM: 00~59 (minute); SS: 00~59 (second)</td> </tr> </tbody> </table>	Format	Description	HH:MM	HH: 00~23 (hour); MM: 00~59 (minute)	HH:MM:SS	HH: 00~23 (hour); MM: 00~59 (minute); SS: 00~59 (second)
	Format	Description						
	HH:MM	HH: 00~23 (hour); MM: 00~59 (minute)						
	HH:MM:SS	HH: 00~23 (hour); MM: 00~59 (minute); SS: 00~59 (second)						
	Show Date	Check this option if you want to display date on the left top of the historic trend graph object. You need to select a format for displaying the date.						
Date Format	The format of how the date is displayed. There are 12 kinds of format available: dd/mm/yy, mm/dd/yy, yy/mm/dd, dd.mm.yy, mm.dd.yy, yy.mm.dd, dd-mm-yy, mm-dd-yy, yy-mm-dd, dd-MMM-yy, MMM-dd-yy, and yy-MMM-dd. <b>Note:</b> dd: 01~31 (day); mm: 01~12 (month); yy: 00~99 (year); MMM: JAN~DEC (month)							
Time/Date Font	The font of the time/date.							
Time/Date/Tick Color	Select a color for the X axis and its ticks.							
Y Axis	Number of Major Divisions	The number of major divisions for the Y axis. The minimum you can specify is one.						
	Number of Sub-divisions	The number of divisions between two adjacent major ticks. The minimum you can specify is one.						
	Show Ticks	Check this option if you want the Y axis to have ticks.						
	Show X-axis Grid	Select this option if you want the Y axis to have horizontal grids.						
	Grid Color	Select a color for the horizontal grids.						
Y Axis Mark	Show Marks	Check this option if you want the major ticks to have marks.						
	Font	The font of the marks.						
	Dynamic Range	Check this option if you want the minimum and maximum of the marks to be controlled by the dynamic range parameter block of the associated object at runtime.						
	Minimum	The minimum of the marks. You can specify a 32-bit signed integer.						
	Maximum	The maximum of the marks. You can specify a 32-bit signed integer.						
	Total Digits	The total digits to be displayed for the marks.						
	Fractional Digits	The number of fractional digits for the marks. For example, when the Maximum is 5000, the Total Digits is 4, and the Fractional Digits is 2, the mark for the Maximum will be 50.00.						
	Position	Select a position to locate the scale. The scale can be displayed on the left or on the right or on the both side.						
	Mark/Tick Color	Select a color for the marks and ticks.						

## 12.4. Displaying History of Predefined Events Using Historic Event Tables

### 12.4.1. Basic Operations

Follow the steps below to create a historic event table:

- 1) Click Historic Event Table icon in the Object toolbar, or select Historic Event Table in the Object sub-menu.
- 2) Move the cursor to the screen on which you want to create the object.
- 3) Click at the desired position on the screen to place the new object.

You can number the predefined events of your application, use a word in the controller or the target panel to store the number of the current event at runtime, and have a data logger in the target panel to collect the value of that word. This is a way to record the events of your application. You can use the historic event table to display the event history. Each message defined for the historic event table is associated with an event by the message/event number.

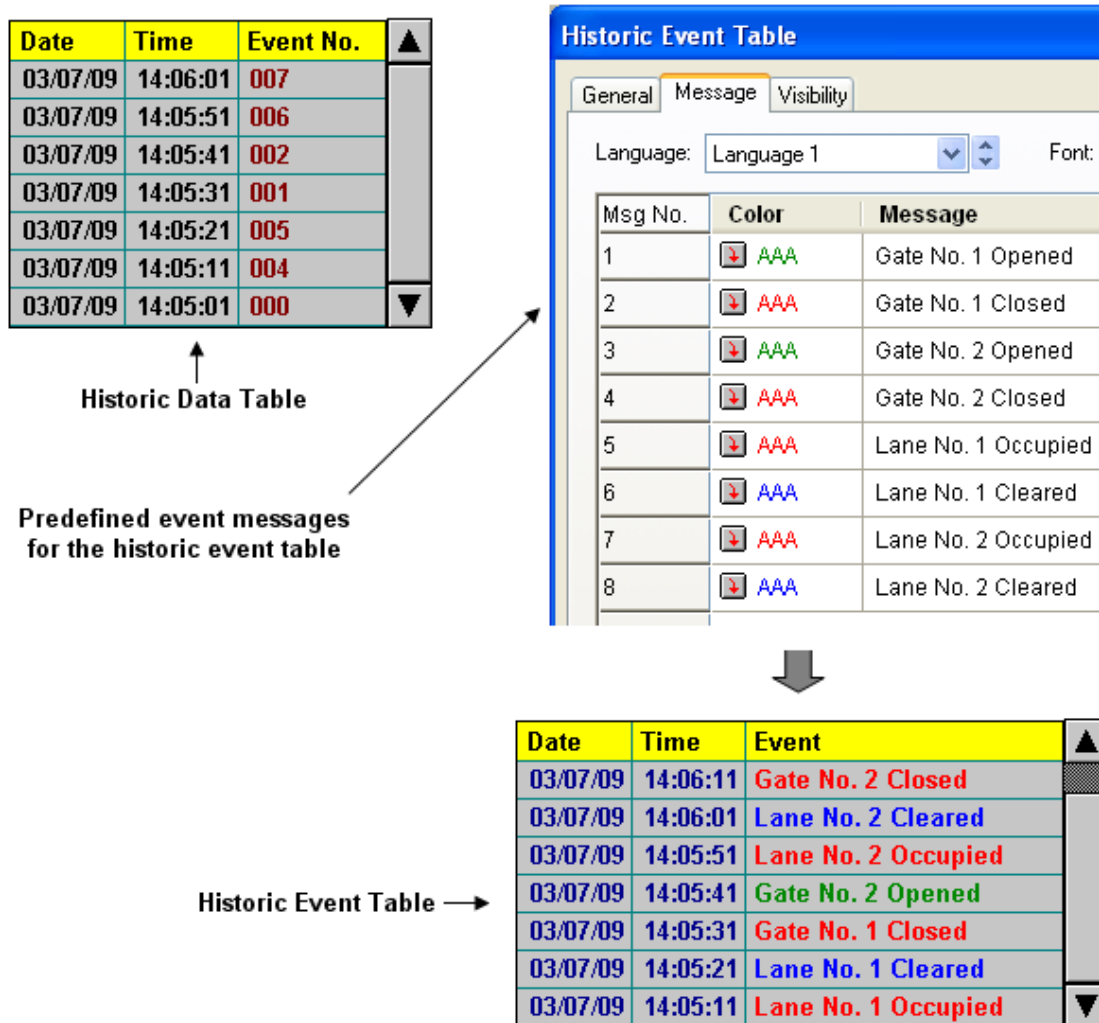

In the above example, the historic data table and the historic event table display the same historic data in different ways.

### 12.4.2. Operation Options

The following operation option can be added to a historic event table. Select and set the option in the Historic Event Table dialog box.

Options	Description
Visibility Control	You can show and hide a historic event table by a specified bit or the current user level. Select and set this option in the Visibility page.



### 12.4.3. Settings

You can set up a historic event table with the Historic Event Table dialog box. There are three ways to open the dialog box of an object:

- 1) Double-click the object.
- 2) Right-click the object to bring up the Object pop-up menu. Select Properties in the pop-up menu.
- 3) In the Object List window, double-click the row that displays the information of the object.

You can complete all the settings of a historic event table in the Historic Event Table dialog box. This dialog box contains the following three pages.

- **General**

Described in [Section 12.4.4.](#)

- **Message**

Described in [Section 12.4.5.](#)

- **Visibility**

Described in [Section 4.4.6.](#)



### 12.4.4. General Settings

This section describes how to define the general settings for a historic event table. The following is an example of the General page.

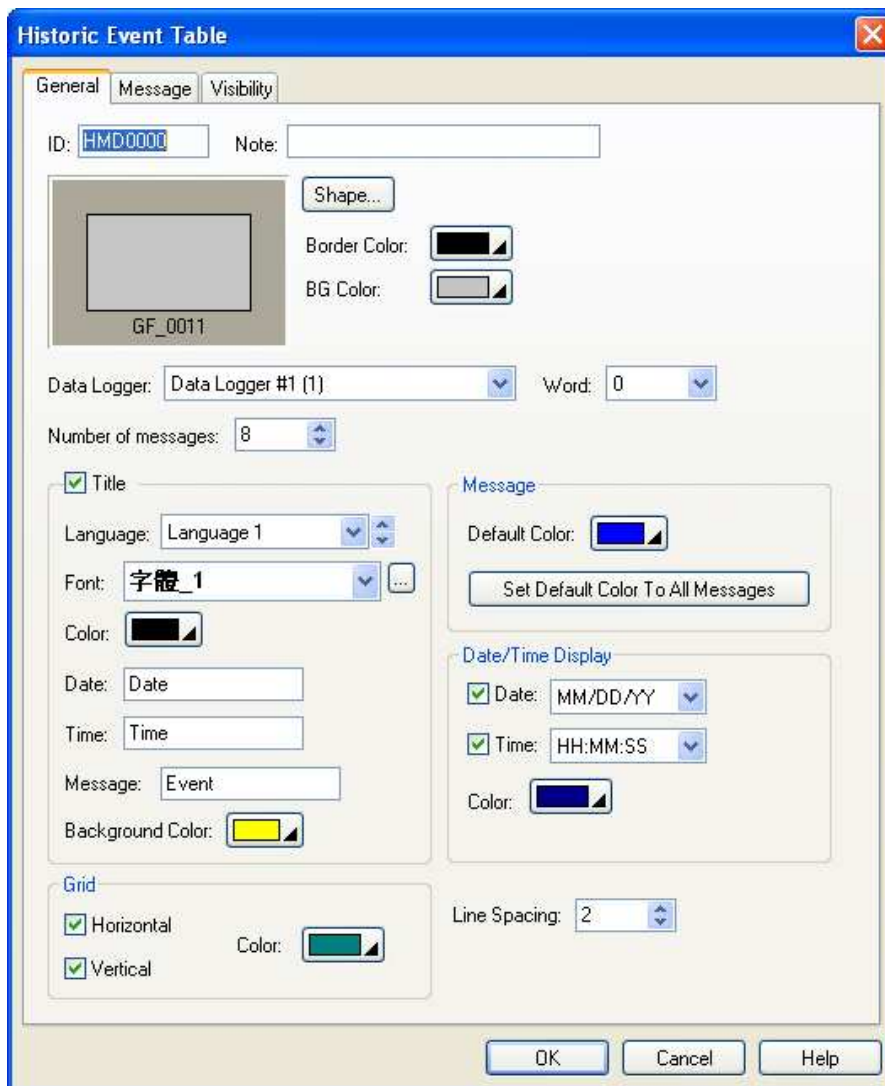

The following table describes each property in the General page.

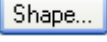
Property	Description
ID	The object's identifier. It is generated when the object is created and is unchangeable. The identifier is unique within the screen where the object is on. The format of the ID's for the historic event tables is HMDnnnn.
Note	You can type a note for the object.
Shape settings	For details about the following properties, see <a href="#">Section 4.3.4 Setting up the Shape of an Object</a> .  , Border Color, BG Color
Data Logger	Specifies the associated data logger. The object will take a specified word in each of the data records collected by the data logger as the event number and displays a corresponding message for that number.
Word	Specifies the number of the word in each of the data records that stores the event number.
Number of messages	Specifies the number of event messages.

Continued



Property		Description
Title	Title	Select this option if you want to have a title row.
	Language	Select a language so you can view and edit the settings of the title row for that language.
	Font	Select a font for the title text.
	Color	Select a color for the text.
	Date	Specifies the title for the Date column.
	Time	Specifies the title for the Time column.
	Message	Specifies the title for the Message column.
	Background Color	Select a color for the background of the title row.
Grid	Vertical	Check this option if you want the object to display vertical grids.
	Horizontal	Check this option if you want the object to display horizontal grids.
	Color	Select a color for the grids.
Message	Font	Select a font for displaying messages.
	Default Color	Select a color as the default message color.
	Set Default Color To All Messages	Click this button to set the colors of all the messages to the Default Color.
Date/Time Display	Date	Check this option if you want the object to display the Date column. You need to select a format for displaying the date.
	Time	Check this option if you want the object to display the Time column. You need to select a format for displaying the time.
Line Spacing		Specifies the extra space in pixels for two adjacent rows in the table.

### 12.4.5. Message Settings

This section describes how to define the messages of the historic event table. The following is an example of the Message page.

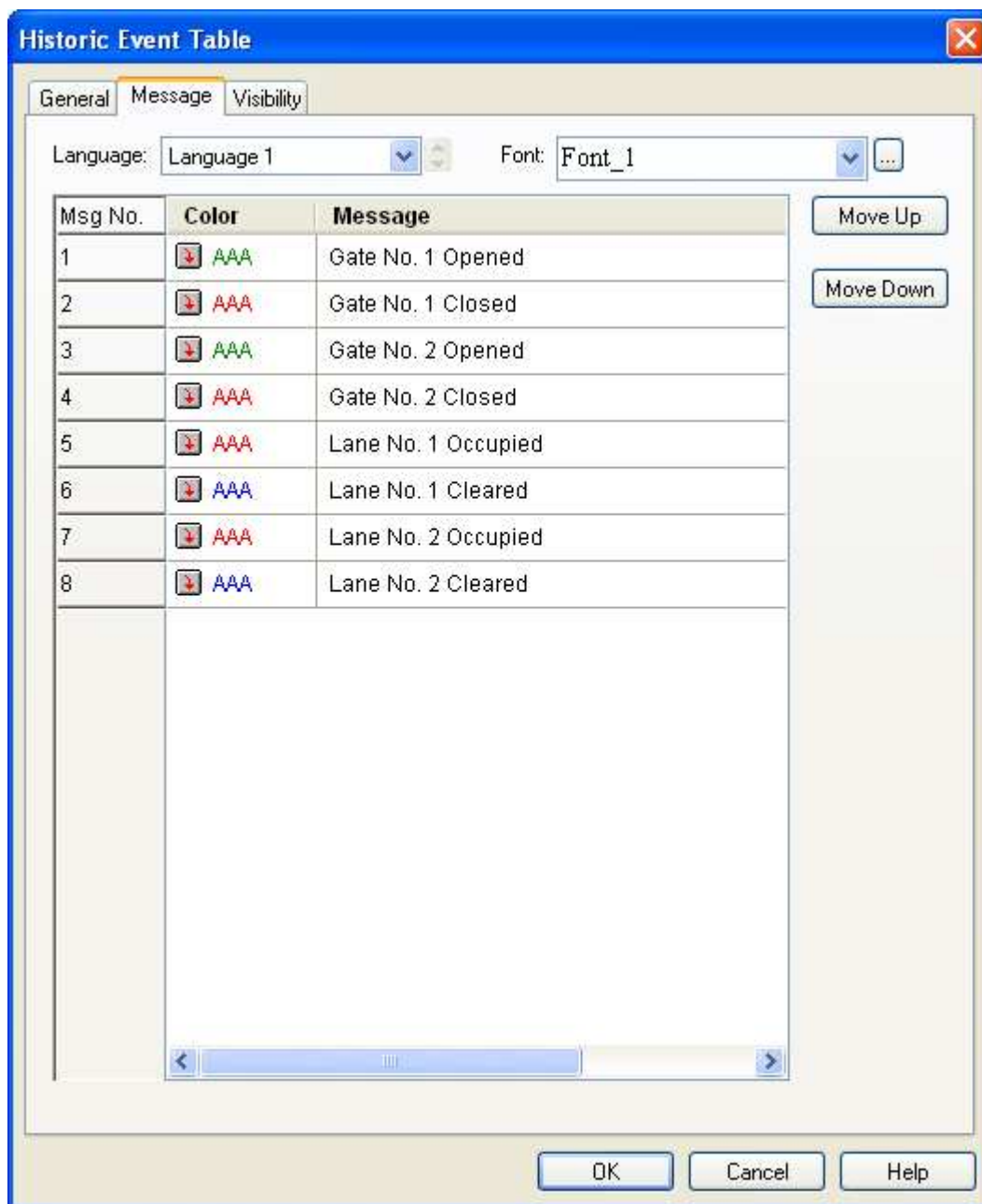

The following table describes each property in the Message page.

Property		Description
Language		Select a language so you can view and edit the settings for that language.
Font		Select a font for displaying the messages.
No. 1~N	Color	Select a color for displaying the message of the associated event.
	Message	Define the text message for the associated event.



## 12.5. Displaying Time Slice Data Profile Using Single Record Line Charts

### 12.5.1. Basic Operations

Use the following steps to create a single record line chart:

- 1) Click Single Record Line Chart icon in the Object toolbar, or select Single Record Line Chart in the Object sub-menu.
- 2) Move the cursor to the screen on which you want to create the object.
- 3) Click at the desired position on the screen to place the new object.

You can use a single record line chart to display the values of the data collected by a data logger as a line chart.

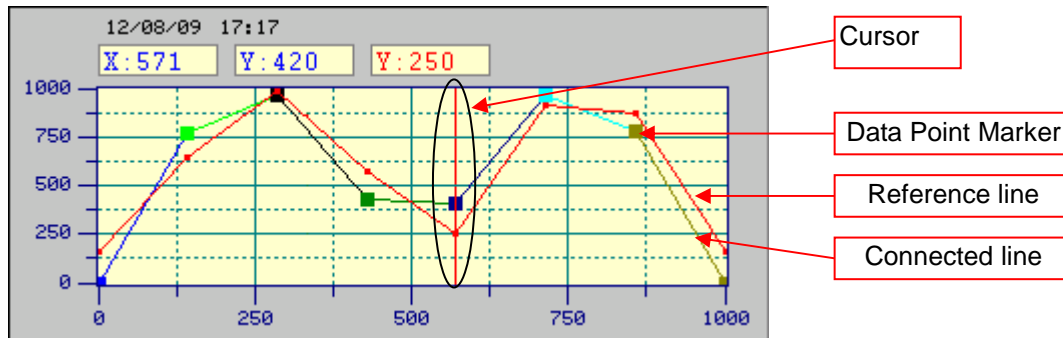

A single record line chart can display up to 255 data points. The above is an example of the single record line chart with 8 data points. A single record line chart can provide a cursor for you to estimate the value in the desired pointer.



### 12.5.2. Operation Options

The following operation option can be added to a historic trend graph. Select and set the option in the Historic Trend Graph dialog box.

Options	Description
Visibility Control	You can show and hide a historic trend graph by a specified bit or the current user level. Select and set this option in the Visibility page.

### 12.5.3. Settings

You can set up a single record line chart with the Single Record Line Chart dialog box. There are three ways to open the dialog box of an object:

- 1) Double-click the object.
- 2) Right-click the object to bring up the Object pop-up menu. Select Properties in the pop-up menu.
- 3) In the Object List window, double-click the row that displays the information of the object.

The Single Record Line Chart dialog box contains the following four pages:

- **General**

Described in [Section 12.5.2.](#)

- **Pen**

Described in [Section 12.5.3.](#)

- **Axis**

Described in [Section 12.5.4.](#)

- **Visibility**

Described in [Section 4.3.6.](#)

### 12.5.4. General Settings

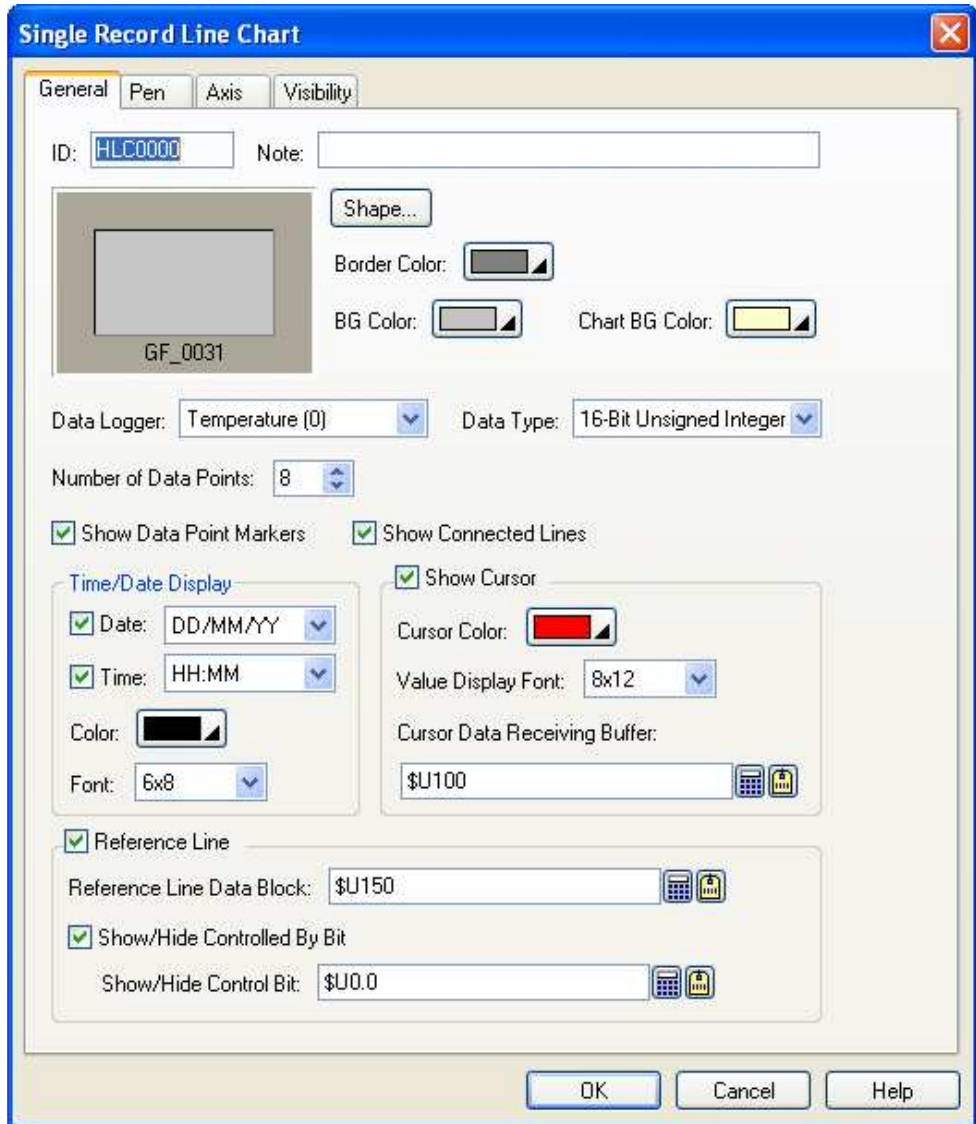







The following table describes each property in the General page.

Property	Description
ID	The object's identifier. It is generated when the object is created and is unchangeable. The identifier is unique within the screen where the object is on. The format of the ID's for the Single Record Line Charts is HLCnnnn.
Note	You can type a note for the object.
Shape settings	For details about the following properties, see <a href="#">Section 4.3.4 Setting up the Shape of an Object</a> . <b>Shape...</b> , Border Color, BG Color
Data Logger	Specifies the associated data logger.
Data Type	The data type of the data logger. The supported data types include: 16-Bit Unsigned Integer, 32-Bit Unsigned Integer, 16-Bit Signed Integer, 32-Bit Signed Integer, 16-Bit BCD, 32-Bit BCD, 32-Bit Floating Point, 16-Bit Signed BCD (LMB), 32-Bit Signed BCD (LMB), 16-Bit Signed BCD (LMD), and 32-Bit Signed BCD (LMD).
Number of Data Points	Specifies the number of data points.

Continued



Property		Description
Show Data Point Markers		Check this option so the line chart will put a square mark on every data point.
Show Connected Lines		Check this option so the single record line chart will display a line connecting all the data points in sequence.
Time/Date Display	Date	Check this option if you want the object to display the Date column. You need to select a format for displaying the date.
	Time	Check this option if you want the object to display the Time column. You need to select a format for displaying the time.
	Color	Select a color for the text.
	Font	Select a font for the title text.
Show Cursor	<Check Box>	Check this option so the single record line chart will display a cursor. You can touch and drag the cursor to the data point(s) that you want to select.
	Cursor Color	Select a color for the cursor.
	Value Display Font	Select a font for displaying the values of the selected data point(s).
	Cursor Data Receiving Buffer	The variable whose data is to be read and displayed the cursor data. Click  to enter an address for this field. Click  to select a tag for this field.
Reference Line	<Check Box>	Check this option so the single record line chart will display a reference line.
	Reference Line Data Block	The variable whose data is to be read and displayed the reference data. Click  to enter the word address. Click  to enter the word tag.
	Show/Hide Controlled By Bit	Check this option if you want to show or hide the reference line controlled by the specified bit.
	Show/Hide Control Bit	Specifies the bit that controls the reference line show/hide. Click  to enter the bit address. Click  to enter the bit tag.

### 12.5.5. Pen Settings

This section describes how to define the pens for the line charts. The following is an example of the Pen page.

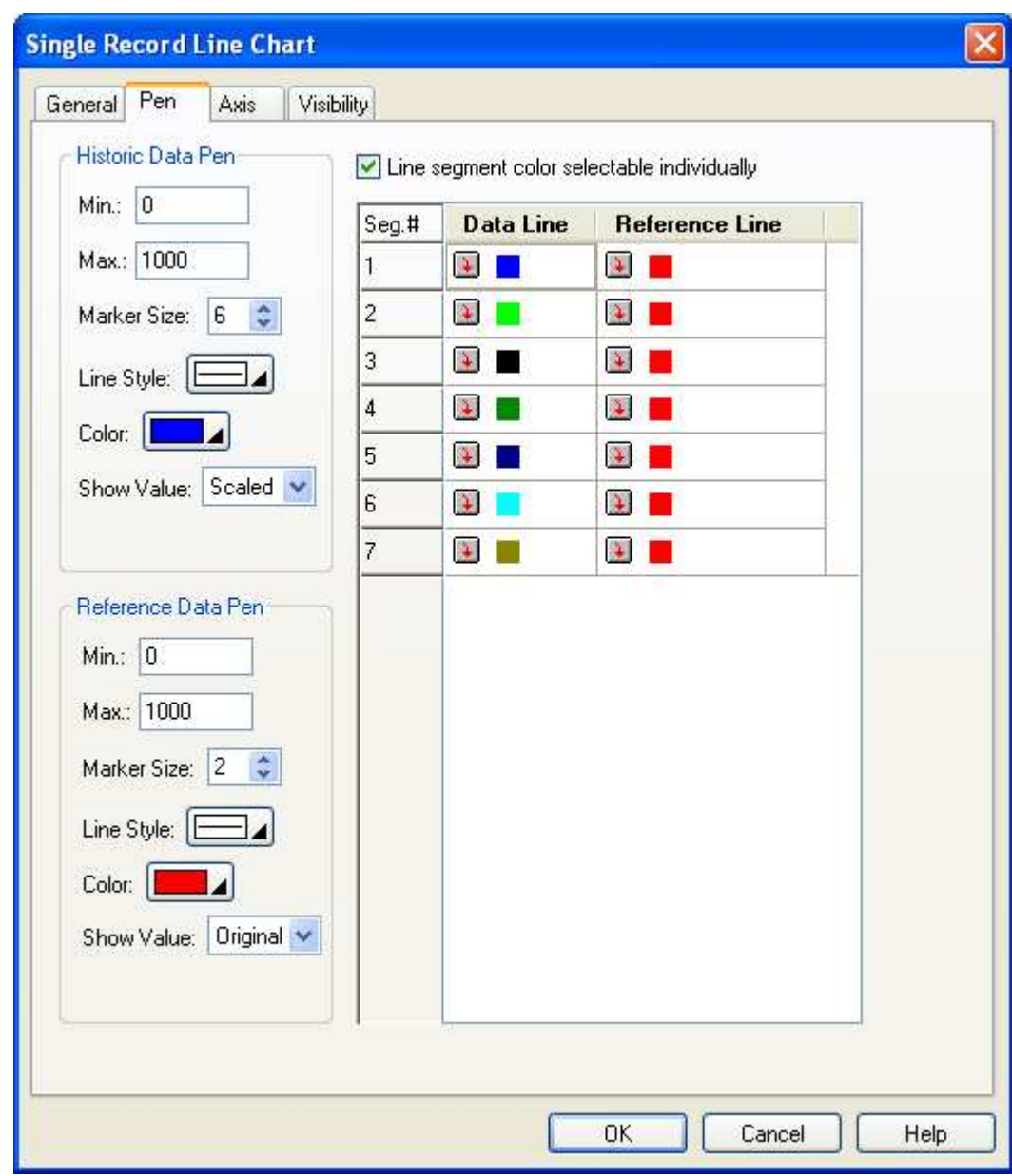





The following table describes each property in the Pen page.

Property		Description							
Historic Data Pen	Min.	The minimum of the associated data set. This property is available when the Dynamic Range option is not selected.							
	Max.	The maximum of the associated data set. This property is available when the Dynamic Range option is not selected.							
	Mark Size	Select a size for the data point mark. The selection is valid when the Show Mark option in the General page is selected.							
	Line Style	Select a style for the connecting lines. The selection is valid when the Show Line option in the General page is selected.							
	Color	Select a color for the connecting lines.							
	Show Value	<p>Select one of the following methods for displaying the selected data point value.</p> <table border="1"> <thead> <tr> <th>Show Value</th> <th>Description</th> </tr> </thead> <tbody> <tr> <td>(None)</td> <td>Does not display the data point value.</td> </tr> <tr> <td>Original</td> <td>Displays the data point value without modification.</td> </tr> <tr> <td>Scaled</td> <td>Displays the corresponding Y axis value of the data point.</td> </tr> </tbody> </table> <p>The selection is valid when the Show Cursor option in the General page is selected.</p>	Show Value	Description	(None)	Does not display the data point value.	Original	Displays the data point value without modification.	Scaled
Show Value	Description								
(None)	Does not display the data point value.								
Original	Displays the data point value without modification.								
Scaled	Displays the corresponding Y axis value of the data point.								
Reference Data Pen	Min.	The minimum of the associated data set. This property is available when the Dynamic Range option is not selected.							
	Max.	The maximum of the associated data set. This property is available when the Dynamic Range option is not selected.							
	Mark Size	Select a size for the data point mark. The selection is valid when the Show Mark option in the General page is selected.							
	Line Style	Select a style for the connecting lines. The selection is valid when the Show Line option in the General page is selected.							
	Color	Select a color for the connecting lines.							
	Show Value	<p>Select one of the following methods for displaying the selected data point value.</p> <table border="1"> <thead> <tr> <th>Show Value</th> <th>Description</th> </tr> </thead> <tbody> <tr> <td>(None)</td> <td>Does not display the data point value.</td> </tr> <tr> <td>Original</td> <td>Displays the data point value without modification.</td> </tr> <tr> <td>Scaled</td> <td>Displays the corresponding Y axis value of the data point.</td> </tr> </tbody> </table> <p>The selection is valid when the Show Cursor option in the General page is selected.</p>	Show Value	Description	(None)	Does not display the data point value.	Original	Displays the data point value without modification.	Scaled
Show Value	Description								
(None)	Does not display the data point value.								
Original	Displays the data point value without modification.								
Scaled	Displays the corresponding Y axis value of the data point.								
Line segment color selectable individually	Check this option to set the line segment color individually in the following list window. The list window has three columns. The first column is line segment number. The second column is color setting for the data line. The third column is the color setting for reference line.								



### 12.5.6. Axis Settings

This section describes how to define the X axis and the Y axis for the single record line charts.

The following is an example of the Axis page.

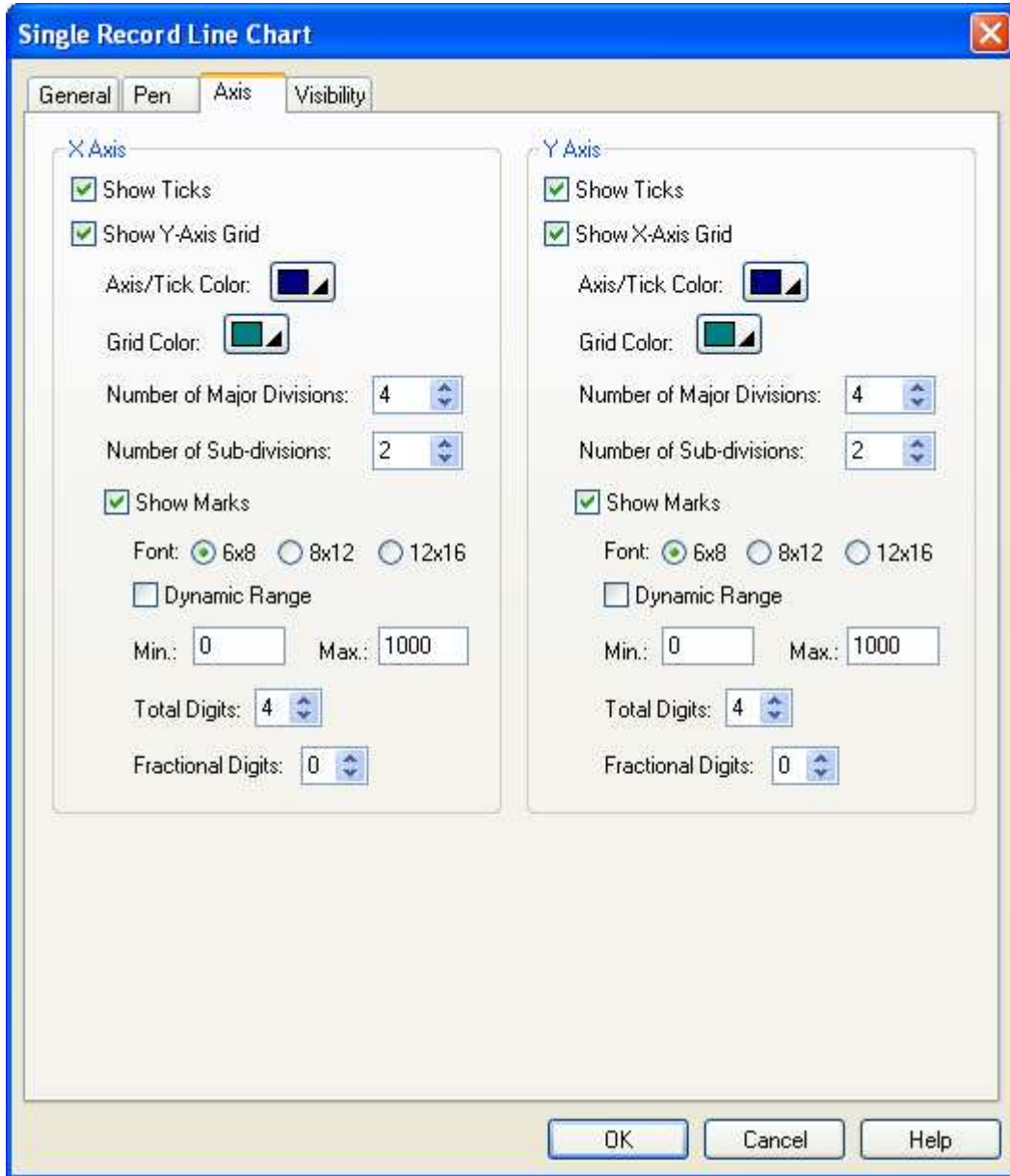



The following table describes each property in the Axis page.

Property		Description
X Axis	Show Ticks	Check this option if you want the X axis to have ticks.
	Show Y-axis Grid	Select this option if you want the X axis to have vertical grids.
	Axis/Tick Color	Select a color for the X axis and its ticks.
	Grid Color	Select a color for the vertical grids.
	Number of Major Divisions	The number of major divisions for the X axis. The minimum you can specify is one.
	Number of Sub-divisions	The number of divisions between two adjacent major ticks. The minimum you can specify is one.
Mark	Show Marks	Check this option if you want the major ticks to have marks.
	Font	The font of the marks.
	Dynamic Range	Check this option if you want the minimum and maximum of the marks to be controlled by the dynamic range parameter block of the associated object at runtime.
	Min.	The minimum of the marks. It is a 32-bit integer.
	Max.	The maximum of the marks. It is a 32-bit integer.
	Total Digits	The total digits to be displayed for the marks.
	Fractional Digits	The number of fractional digits for the marks. For example, when the Maximum is 5000, the Total Digits is 4, and the Fractional Digits is 2, the mark for the Maximum will be 50.00.
Y Axis	Show Ticks	Check this option if you want the Y axis to have ticks.
	Show X-axis Grid	Select this option if you want the Y axis to have horizontal grids.
	Axis/Tick Color	Select a color for the X axis and its ticks.
	Grid Color	Select a color for the horizontal grids.
	Number of Major Divisions	The number of major divisions for the Y axis. The minimum you can specify is one.
	Number of Sub-divisions	The number of divisions between two adjacent major ticks. The minimum you can specify is one.
Mark	Show Marks	Check this option if you want the major ticks to have marks.
	Font	The font of the marks.
	Dynamic Range	Check this option if you want the minimum and maximum of the marks to be controlled by the dynamic range parameter block of the associated object at runtime.
	Min.	The minimum of the marks. You can specify a 32-bit signed integer.
	Max.	The maximum of the marks. You can specify a 32-bit signed integer.
	Total Digits	The total digits to be displayed for the marks.
	Fractional Digits	The number of fractional digits for the marks. For example, when the Maximum is 5000, the Total Digits is 4, and the Fractional Digits is 2, the mark for the Maximum will be 50.00.



# CHAPTER 13

## OPERATION LOGGING

<b>13.1. Using Operation Logging</b> .....	1
<b>13.2. Setting up Operation Logging</b> .....	2
<b>13.3. Setting up Operation Log Displays</b> .....	3
13.3.1. Basic Operations.....	3
13.3.2. Operation Options.....	3
13.3.3. Settings.....	3
13.3.4. General Settings .....	4



This chapter describes how to set up the operation logging and configure the operation log display to show the operation loggers.

## 13.1. Using Operation Logging

To use an operation logging in your application, please do the followings:

1. Setting up Operation Logging  
Described in [Section 13.2](#)
2. Adding custom operation message in the Advanced page of the related object  
Described in [Section 4.4.5](#)

The screenshot shows the 'Advanced' tab of a configuration window for 'Touch Operation Control'. The 'Operation Logging' checkbox is checked. The 'Message' field contains the text 'Start pump #3'. A red box highlights the 'Message' field and its edit button. Two red arrows point from callout boxes to the edit button and the message text.

Enter the operation message of the first language.

Click the button to bring up the Operation Message dialog box that you can edit the operation message for all the languages.

3. Creating and configuring Operation Log Displays  
Described in [Section 13.3](#)

PM Designer also lets user clear the operation logging buffer by the function button. To know how to define a function button to clear the operation history, please see [Section 5.4.1 Basic Operations](#) of function buttons.

## 13.2. Setting up Operation Logging

You can set up the operation logging with the Operation Logging dialog box. In this dialog, you can determine the required memory for operation logging buffer, specify how to save the operation logs to a text file. To open the dialog box, please double click the node named Operation Logging in the PM Designer's Project Manager tool window or use Operation Logging... command on the Panel menu. The following is an example of the Operation logging dialog box.

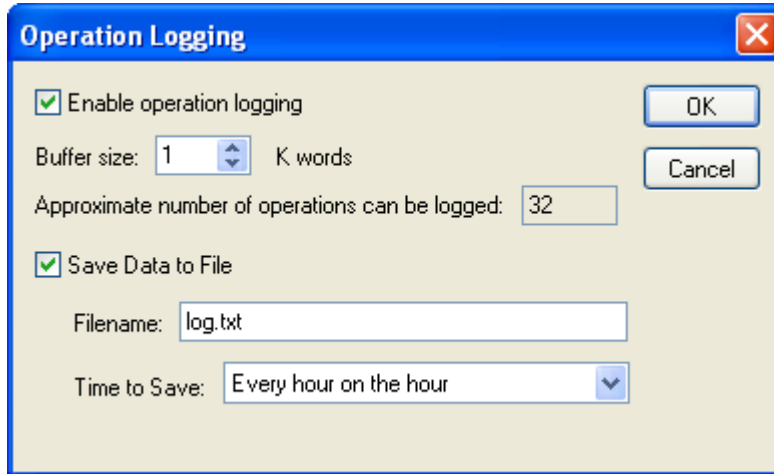

The table below describes each property in the Operation Logging Properties dialog.

Property		Description
Enable operation logging	<Check Box>	Check this option to enable the operation logging.
	Buffer Size	The size of operation logging buffer. The unit is K words. The buffer size can be specified between 1 and 512 K words.
	Approximate number of operations can be logged	The maximum number of operation loggers that the operation logging buffer can hold. The formula to calculate the approximate number is: Number = Buffer Size * 1024 * 2 / 64
Save Data to File	<Check Box>	Check this option so the newly operation loggers will be written to a specified file periodically. Each time when performing the saving, the panel writes only the operation loggers that are not saved to a file before.
	File Name	The filename or the prefix of the filename of the file to save the operation loggers. The operation loggers are saved in text format and the file extension name must be ".txt". You can use any text editor and Microsoft Excel to view the operation loggers directly. This item is available when the option Save Data to File is checked.
	Time to Save	Specifies the period to save the operation loggers. This item is available when the option Save Data to File is checked. There are nine kinds of period available: Every hour on the hour ; Every 8 hours (00:00, 08:00, 16:00) ; Every 12 hours (00:00, 12:00) Every day at 00:00; Every day at 08:00; Every day at 12:00; Every Sunday at 00:00; Every Monday at 00:00; Every month's first day at 00:00.



## 13.3. Setting up Operation Log Displays

### 13.3.1. Basic Operations

You can display a list of operation logs by using an operation log display.

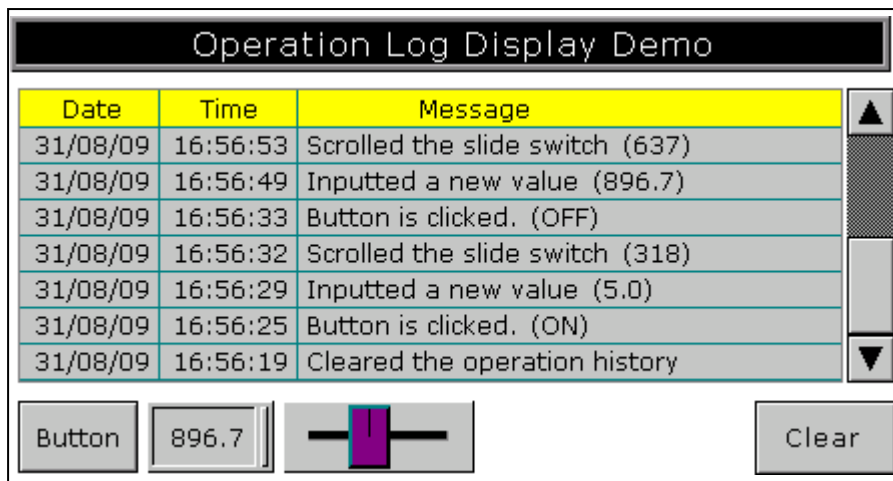

The above is an example of the operation log display. The first row is the title row. It displays the title of each column. The other rows display one operation per row. You can create scroll button groups or scroll bars to scroll the contents. An operation log display can have three columns. The following table describes the content of each column for an operation log display.

Column	Description
Date	The date when the record is created. This column is optional.
Time	The time when the record is created. This column is optional.
Message	The message of the associated operation. This column is optional.

The text color and font of a row is determined by the settings in the General Page.

### 13.3.2. Operation Options

The following operation option can be added to an alarm display. Select and set the option in the Operation Log Display dialog box.

Options	Description
Visibility Control	You can show and hide an operation log display by a specified bit or the current user level. Select and set this option in the Visibility page.

### 13.3.3. Settings

You can complete all the settings of an operation log display in the Operation Log Display dialog box. This dialog box contains the following two pages.

- **General**

Described in [Section 13.3.3.](#)

- **Visibility**

Described in [Section 4.4.6.](#)



### 13.3.4. General Settings

This section describes how to define the general settings for an operation log display. The following is an example of the General page of the Operation Log Display dialog box.

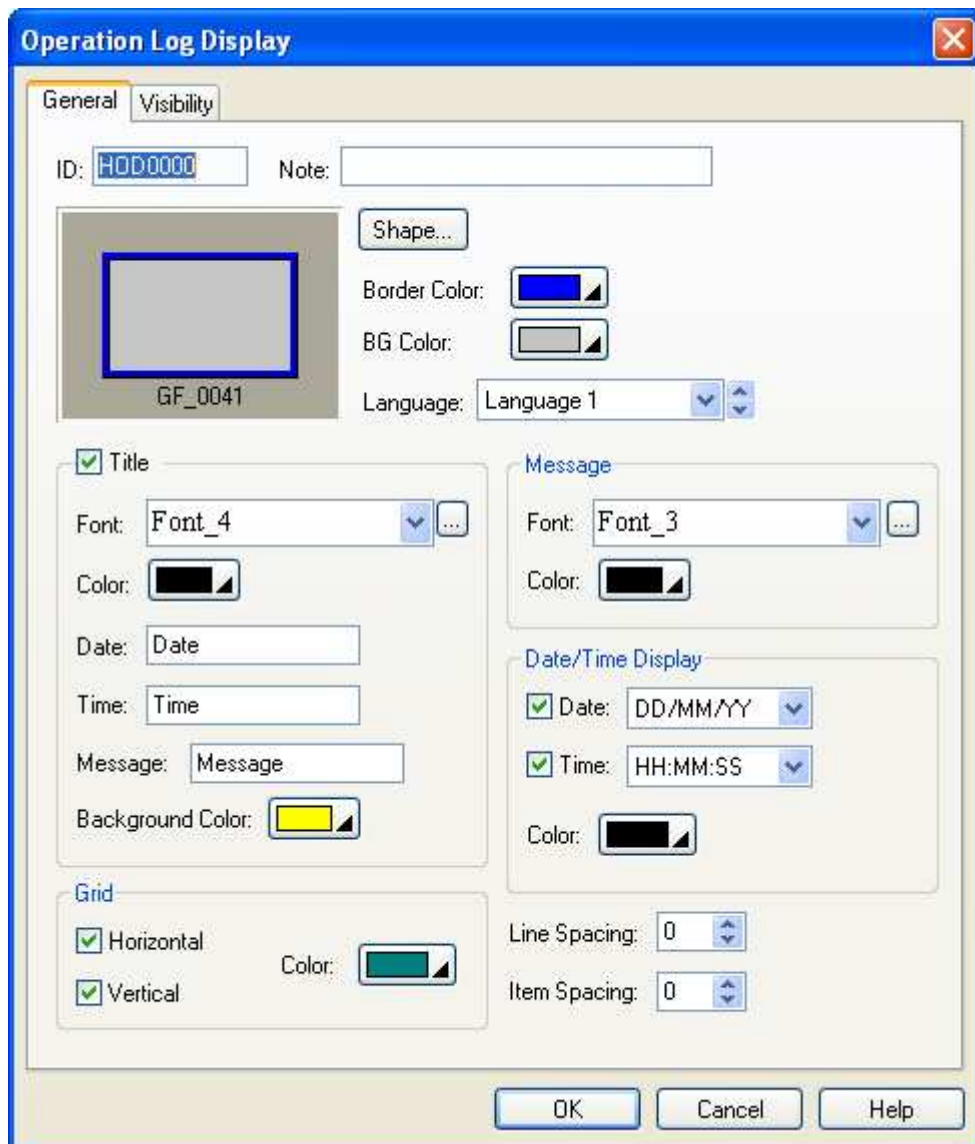

The following table describes each property in the General page.

Property	Description
ID	The object's identifier. It is generated when the object is created. The identifier is unique within the screen where the object is on and is unchangeable. The format of the ID's for the operation log display is HOD####.
Note	You can type a note for the object.
Shape settings	For details about the following properties, see <a href="#">Section 4.3.4 Setting up the Shape of an Object.</a>  , Border Color, BG Color
Language	Select a language so you can view and edit the language dependent settings in the Title group and Message group for that language. The language dependent properties in the Title group include Font and Message; in the Message group include Font.

Continued



Property		Description	
Title	<Check Box>	Select this option if you want the operation log display to have a title row to show the title for each column of the displayed list.	
	Font	Select a font for the title text.	
	Color	Select a color for the text.	
	Date	Specifies the title for the Date column.	
	Time	Specifies the title for the Time column.	
	Message	Specifies the title for the Message column.	
	Background Color	Select a background color for the title row.	
Grid	Horizontal	Select this option if you want the operation log display to have horizontal grids.	
	Vertical	Select this option if you want the operation log display to have vertical grids.	
	Color	Select a color for the grids.	
Message	Font	Select a font for the message.	
	Color	Select a color for displaying the predefined message.	
Date/Time Display	Date	<Check Box>	Check this option if you want the operation log display to have the Date column.
		<Drop-down List>	Select a format for displaying the date
	Time	<Check Box>	Check this option if you want the operation log display to have the Time column.
		<Drop-down List>	Select a format for displaying the time
	Color	Select a color for Date/Time.	
Line Spacing		Specifies the extra space in pixels for two adjacent rows of the operation log display.	
Item Spacing		Specifies the extra space for every column of the operation log display.	

## CHAPTER 14

# USING MACROS

<b>14.1. Types of Macros</b> .....	<b>1</b>
<b>14.2. Working with Macros</b> .....	<b>3</b>
14.2.1. Creating Macros.....	3
14.2.2. Opening and Closing Macros.....	3
14.2.3. Naming a macro.....	4
14.2.4. Deleting a macro.....	4
14.2.5. Saving and Exporting Macros .....	4
14.2.6. Macro Settings in the Dialog .....	5
<b>14.3. Writing Macros</b> .....	<b>7</b>
14.3.1. Macro Editor Window .....	7
14.3.2. Macro Command Properties Tool Window .....	9
<b>14.4. Macro Commands and Examples</b> .....	<b>10</b>
14.4.1. Macro Notations and Terminology.....	10
14.4.2. Data Transfer .....	12
14.4.3. Arithmetic Operation .....	13
14.4.4. Logical Operation.....	14
14.4.5. Calculation .....	16
14.4.6. Data Conversion .....	18
14.4.7. Conditional Operation .....	21
14.4.8. Program Control.....	25
14.4.9. Timer Operation .....	28
14.4.10. Keypad Operation .....	29
14.4.11. Recipe Operation.....	30
14.4.12. Communication Operation.....	31
14.4.13. System Service .....	32
14.4.14. Screen Operation .....	33
14.4.15. File Operation.....	34
14.4.16. Comparison.....	39
14.4.17. String Operation .....	40
14.4.18. Run Operation .....	45
14.4.19. Print Operation .....	46



This chapter explains how you can write macros to perform operations on the PM Designer. A macro contains a sequence of macro commands and acts as a simple computer program when it is run by the PM Designer. With macros, some tasks such as scheduling, data exchanges, conditional operations, and sequential operations that are hard to be performed by the objects can be easily achieved.

**Note:** Do not use macros to control systems that can cause life-threatening and serious injury.

**Note:** The real-time OS in MT (HMI) needs to manage multiple tasks at the same time when the application is running. In order not to affect the whole performance, please keep the macro as short as possible.

**Note:** The macros execute individually and are unaware of the other macros. When sharing common variables between macros, your application might have possible conflicts. Consider an application where the cycle macro updates the value of an address which is used by the event macro. If the event macro alters the address value before the cycle macro uses that address, the result of the cycle macro will be incorrect.

## 14.1. Types of Macros

### ■ Global Macro

A global macro is a macro that can be used by all panel applications in the same project. With global macros, the panel applications in the same projects can share the common functions without having to keep and maintain the same set of macros locally.

You can set up a password in Project Information & Protection dialog box to protect the global macros. If the global macros are under protection, you need to enter password to get off the protection before using them in your application.

**Note** that only internal variables can be used in global macros.

### ■ Local Macro

A local macro is a macro that can be only used by the panel application which the macro is located in.

### ■ Sub-macro

A sub-macro is a macro that other macros can run it by using CALL command. When the PM Designer encounters a CALL command while running a macro, it stops running that macro and starts to run the called sub-macro. The last command of a sub-macro must be a RET command which terminates the sub-macro and returns the control to the calling macro. You can also place RET commands at any locations as you want. The PM Designer will resume the execution of the calling macro starting from the command following the CALL command when the called sub-macro terminates and returns.

By implementing common functions in sub-macros for other macros to use, your macros can be modularized, sharable, easy to read, and easy to maintain.

■ **Startup Macro, Main Macro, Event Macro, Time Macro** for the application

■ **Open Macro, Cycle Macro, Close Macro** for the screen

■ **On Macro, Off Macro, Object Macro** for the object

Select the macro that works best for the occasion you want the macro to run, and for the purpose you want the macro to do.

Run the Macro:	Use:
When the application starts	<p><b>Startup Macro</b></p> <p>This macro is run only once when the application starts. The MT will not display the start-up screen until the macro terminates. You can use Startup Macro to initialize global data and settings for your application. Specify Startup Macro in Panel General Setup dialog box.</p>
While the application is running	<p><b>Main Macro</b></p> <p>This macro is run all the time while the application is running. The MT runs Main Macro cyclically, i.e. it will run Main Macro starting from the first command again each time after it completes the processing of the last command of the macro or when it encounters an END command in the middle of the macro. Specify Main Macro in Panel General Setup dialog box.</p>

Continued



Run the Macro:	Use:
When a specific trigger bit changes from 0 to 1	<p><b>Event Macro</b></p> <p>An Event Macro is run whenever the associated trigger bit changes from 0 (off) to 1 (on). An application can have up to four Event Macros which are numbered from 1 to 4. Specify Event Macros in Panel General Setup dialog box.</p>
Periodically with a preset time interval	<p><b>Time Macro</b></p> <p>A Time Macro is run periodically with a preset time interval. An application can have up to four Time Macros which are numbered from 1 to 4. Each Time Macro has a different set of time interval options you can choose to specify how often you want it to be run. Specify Time Macros in Panel General Setup dialog box.</p>
When a specific screen is being opened	<p><b>Open Macro</b></p> <p>An Open Macro is run once when the associated screen is being opened. The MT will not display the screen until the Open Macro terminates. Specify the Open Macro of a screen in Screen Properties dialog box.</p>
While a specific screen is open	<p><b>Cycle Macro</b></p> <p>A Cycle Macro is run all the time while the associated screen is open. The MT runs Cycle Macros cyclically, i.e. it will run a Cycle Macro starting from the first command again each time after it completes the processing of the last command of the macro or when it encounters an END command in the middle of the macro. And the cycle macro terminates immediately if the screen is closed. Specify the Cycle Macro of a screen in Screen Properties dialog box.</p>
When a specific screen is being closed	<p><b>Close Macro</b></p> <p>A Close Macro is run once when the associated screen is being closed. The MT will not erase the screen until the Close Macro terminates. Specify the Close Macro of a screen in Screen Properties dialog box.</p>
When a specific button is pressed or released to set a bit to on	<p><b>On Macro</b></p> <p>An On Macro is run once when the associated button is pressed or released to set a bit to 1 (on). The setting of the bit will not be performed until the On Macro terminates. So it is important to keep the On Macro as short as possible in order not to delay the setting of the bit. Both the Bit Buttons and the Toggle Switches can have an On Macro. Specify the On Macro of a button in that button's configuration dialog box.</p>
When a specific button is pressed or released to set a bit to off	<p><b>Off Macro</b></p> <p>An Off Macro is run once when the associated button is pressed or released to set a bit to 0 (off). The setting of the bit will not be performed until the Off Macro terminates. So it is important to keep the Off Macro as short as possible in order not to delay the setting of the bit. Both the Bit Buttons and the Toggle Switches can have an Off Macro. Specify the Off Macro of a button in that button's configuration dialog box.</p>
When a specific object is activated to perform a specific operation	<p><b>Object Macro</b></p> <p>An Object Macro is run once when the associated object is activated to perform a specific operation. Whether the macro is run before or after the operation is performed depends on the type of that operation. The objects that can have an Object Macro include Screen Buttons, Function Buttons, and Keypad Buttons. Specify the Object Macro of an object in that object's configuration dialog box.</p>



## 14.2. Working with Macros

### 14.2.1. Creating Macros

#### ■ Creating a new and blank macro

- 1) To create a global macro, use the Add... command on the Project > Global Macro menu, or right-click the Global > Global Macros item in the Project Manager tool window to bring out the popup menu and then use the Add Macro... command on the popup menu.

To create a local macro, use the Add... command on the Panel > Macro menu, or right-click the panel application > Macros item in the Project Manager tool window to bring out the popup menu and then use the Add Macro... command on the popup menu, or

- 2) In New Macro dialog box, type the name you want, and hit the ENTER key or click the OK button to validate your choice.

#### ■ Importing an existing macro as a copy macro

- 1) To import a macro as a global macro, right-click the Global > Global Macros item in the Project Manager tool window to bring out the popup menu and then use the Import Macro... command on the popup menu.

To import a macro as a local macro, right-click the panel application > Macros item in the Project Manager tool window to bring out the popup menu and then use the Import Macro... command on the popup menu

- 2) Click the \*.mcr or \*.txt file you want to create a new macro from. If you want to open a macro that was saved in a different folder, locate and open the folder first.
- 3) Click Open.

**Note:** The macro is created that contains the macro in the file.

### 14.2.2. Opening and Closing Macros

#### ■ Opening an existing macro

To open a global macro, select the macro you want to open on Project > Global Macro > Edit menu, or double click the macro in Global > Global Macros item in the Project Manager tool window, or in Macro settings of the object configuration dialog, select the macro that is located after "-----Global-----" item in the drop-down list.

To open a local macro, select the macro you want to open on Panel > Macro > Edit menu, or double click the macro in the panel application > Macros item in the Project Manager tool window, or in Macro settings of the object configuration dialog, if global macros exist, select the macro that is located from the beginning to "-----Global-----" item in the drop-down list or select the macro in the drop-down list.

#### ■ Opening a \*.txt or \*.mcr file within the macro editor window:

You may do the drag-and-drop operation:

- 1) Open macro editor window by clicking any of the existing macro
- 2) Drag a selection of \*.mcr file or \*.txt file into the macro editor window and drop it.

**Note:** All the macros in the macro editor window will be replaced by macros from the source file.

#### ■ Closing Macro Editor Windows:

To close a single window, select the window and click the close button.

To close all windows, choose Windows... on the Window menu, select all the macro editor windows you want to close in the window dialog and then click Close Window(s) button.

**Note:** The Macro Command Properties Window will be closed automatically when the macro editor window is closed. Even if the macro editor window is closed, all the changes will be saved unless PM Designer exits without saving the file.

#### ■ Closing Macro Command Properties Window:

To close the macro command properties window, click the close button on the Macro Command Properties window or check/uncheck the Macro Command Properties command on the View menu

### 14.2.3. Naming a macro

When adding a new macro for global using or for the panel application, you need to specify the macro name by the following dialog.

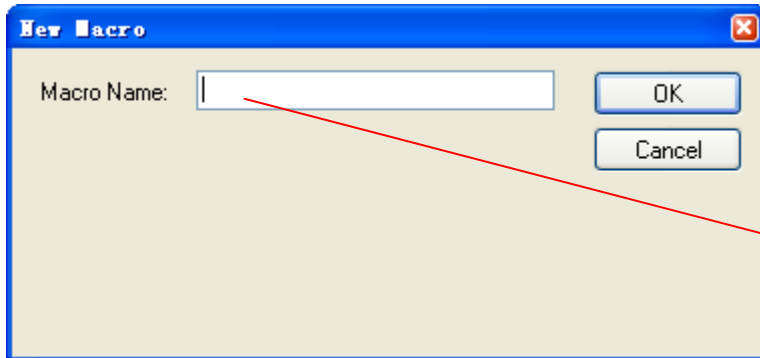

Specify the macro name here. The maximum length for a macro name is 256 characters. And the macro names are case insensitive. For example, consider the names TURN ON, turn on to be the same.

When importing a file as the macro, the file name will be the macro name as default.

In each panel application, the local macro name has to be unique, but a local macro name can be the same as a global macro name.

#### ■ Renaming a macro from Project Manager:

- 1) Locate the macro you would like to rename
- 2) Right-click on the macro to display the macro item's popup menu; and then click Rename, the second menu item.
- 3) The macro name will become selected, simply type the new name over the selected text, and then press the ENTER key.

### 14.2.4. Deleting a macro

#### ■ Deleting a macro from Project Manager tool widow:

- 1) Locate the macro you would like to delete
- 2) Right-click on the macro to display the macro item's "popup menu"; and then click Delete, the third menu item.

#### ■ Deleting a macro by menu

To delete a global macro, choose Project menu, click Global Macro sub-menu, and select the macro you want to delete on the Delete sub-menu

To delete a local macro, choose Panel menu, click Macro sub-menu, and select the macro you want to delete on the Delete sub-menu

**Note:** You can only select one macro to delete at one time. If the macro you want to delete is used by the application or the object, you will be asked to confirm the deleting operation.

### 14.2.5. Saving and Exporting Macros

If you have macro you want to reuse in another application panel, you can export the macro as a .txt file or a .mcr file. You may do the following:

- 1) Locate the macro you would like to export
- 2) Right-click on the macro to display the macro item's "popup menu"; and then click Export Macro..., the fourth menu item.
- 3) If you want to save a macro in a different folder, locate and open the folder first. then click Save.



### 14.2.6. Macro Settings in the Dialog

You can open and edit a specified macro or create a new macro in the configuration dialog that contains the macro page. The following is an example of the Macro page in Bit Button configuration dialog.

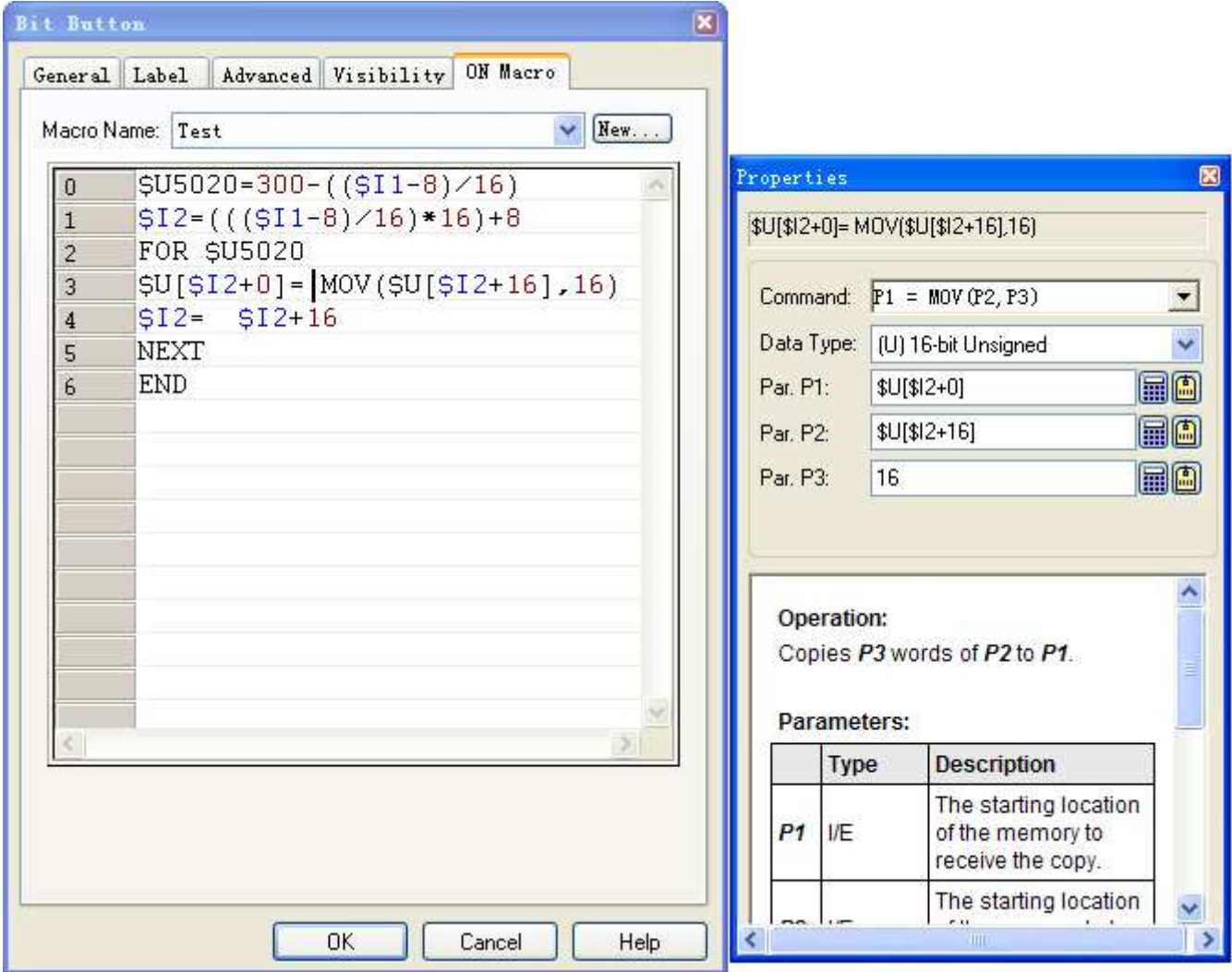

The following table describes each property in the General page.

Property	Description
Macro Name	<p>Select an existing local macros or global macros from the drop-down list. The following is a sample in the dropdown list</p> <div style="border: 1px solid black; padding: 5px; width: fit-content;"> <p>Test</p> <p>SW SCREEN0</p> <p>SW SCREEN1</p> <p>SW SCREEN2</p> <p>SW SCREEN3</p> <p>-----Global-----</p> <p>On</p> <p>Monitor</p> <p>Debug</p> </div> <p style="margin-left: 20px;"> <span style="border: 1px solid red; padding: 2px;">Local Macros</span> (points to the local macro items)</p> <p style="margin-left: 20px;"> <span style="border: 1px solid red; padding: 2px;">Global Macros</span> (points to the global macro separator)</p> <div style="border: 1px solid red; padding: 5px; margin-left: 20px; width: fit-content;"> <p>A separator that is used to separate the local macros and global macros. It shows only when the global macros exist.</p> </div>
New...	Click the button to bring out the New Macro dialog box to create a new and blank local macro.

Continued

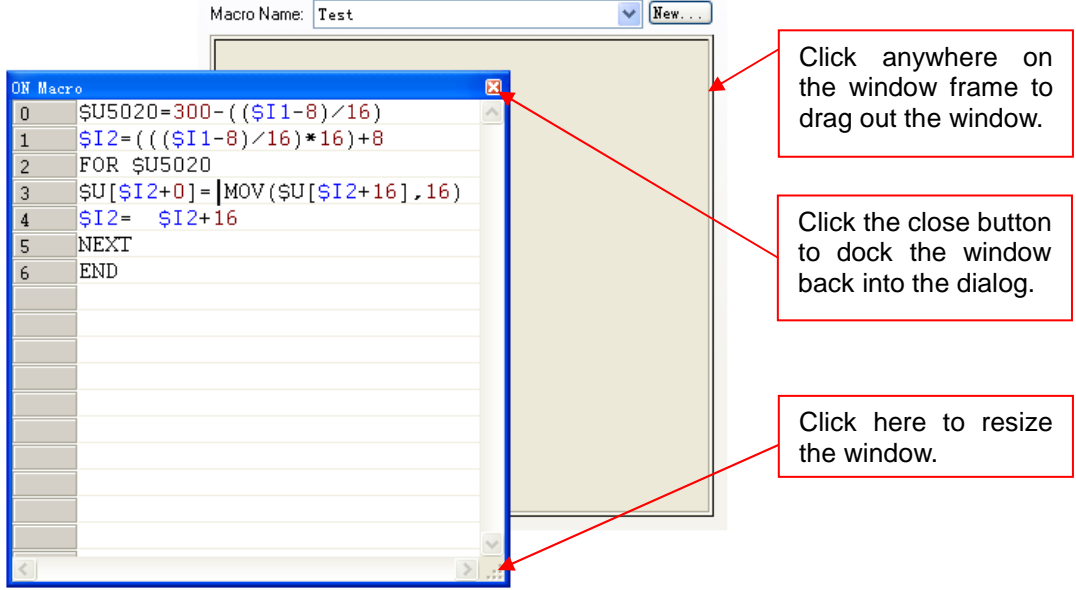

Property	Description
Macro Editor Window	<p>Write and edit the macros here. For details, see <a href="#">Section 14.3.1</a>. If the editor window is too small, you may drag out the window and resize it. To drag and move the window, left-click anywhere on the window frame and hold down the button, and then drag the mouse to move the window outside to another area. It will “float” over the rest of the dialog, allowing you to position it wherever you want it to be. Release the mouse button to let go of the window. Click on the resized tabs located at the right-down corners of the window to resize the window. Press close button to dock the window back into the dialog. The following is a sample of the floating macro editor window.</p>  <p>The screenshot shows a floating window titled "ON Macro" with a close button (X) in the top right corner. The window contains a list of macro commands:</p> <pre>0 \$U5020=300-((SI1-8)/16) 1 \$I2=((SI1-8)/16)*16)+8 2 FOR \$U5020 3 \$U[\$I2+0]=MOV(\$U[\$I2+16],16) 4 \$I2=\$I2+16 5 NEXT 6 END</pre> <p>Three callout boxes with red arrows point to specific parts of the window:</p> <ul style="list-style-type: none"><li>Top right: "Click anywhere on the window frame to drag out the window." (points to the top-right corner)</li><li>Middle right: "Click the close button to dock the window back into the dialog." (points to the close button)</li><li>Bottom right: "Click here to resize the window." (points to the bottom-right corner)</li></ul>
Properties	<p>A floating dialog allows you specify the macro command. For details, see <a href="#">Section 14.3.2</a>. The macro command properties dialog can be moved to anywhere and resized to any size you want. But it can't be closed until the dialog is closed.</p>



## 14.3. Writing Macros

In PM Designer, all the macros can be written in the macro development environment that is composed of two elements: Macro Editor Window and Macro Command Properties Tool Window.

You will see the following sample of the Macro Development Environment when opening a macro from Project Manager,

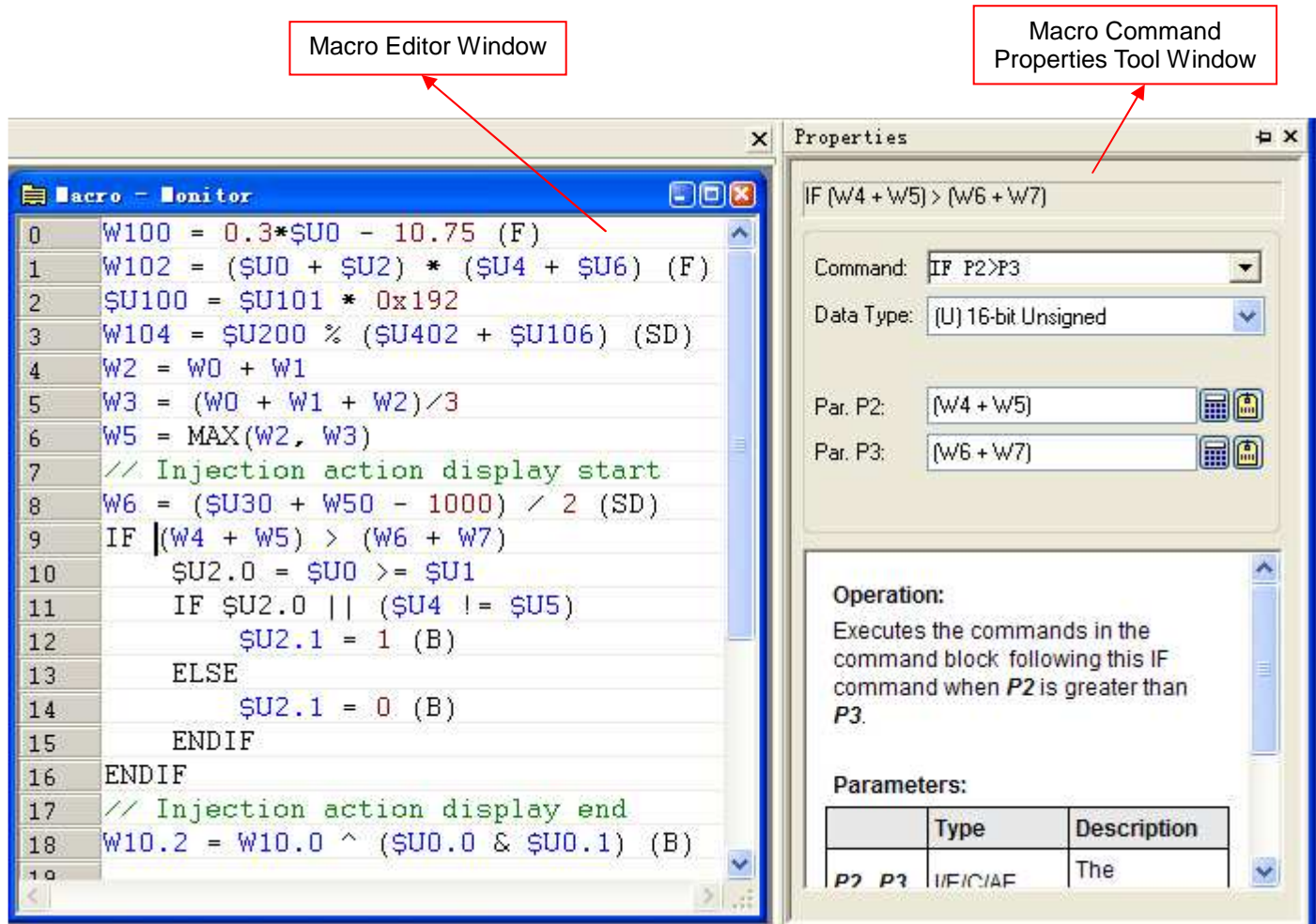

### 14.3.1. Macro Editor Window

The macro editor is a text-based editor with syntax coloring and line numbering. Line numbering in the left margin of the page helps you refer to the specific position of the macro. Syntax coloring gives you visual cues about the structure by using different colors for various elements, such as keywords in black, comments in green, addresses in blue and constants in red.

#### ■ Editing Macro

With the macro editor, you can cut, copy, and paste selected text using menu commands, key combination or drag-and-drop operations. You can also undo and redo selected editing actions.

You can right-click to display a popup menu of editing commands. The editing commands available depend on what the pointer is pointing to.



The macro editor allows the following editing actions:

- Cutting, copying, pasting, and deleting selection of lines, multiple lines or text
- Undoing and redoing editing actions
- Using drag-and-drop editing to move or copy selection of text within one macro editor window, or between macro editor windows.

The following table shows the supported editing commands.

Menu Command	Key Combination	Description
<b>Cut</b>	CTRL+X	Removes selected text from the active macro editor window.
<b>Copy</b>	CTRL+C	Duplicates selected text in the active macro editor window.
<b>Paste</b>	CTRL+V	Pastes cut or copied text into an active macro editor window.
	DELETE	Deletes text without copying it to the Clipboard.
<b>Undo</b>	CTRL+Z	Reverses the last editing action.
<b>Redo</b>	CTRL+Y	Reapplies the prior editing that have been undone.
	CTRL+A	Selects all texts in the active macro editor

Note that all editing commands require a selection in order to work. Some commands can make a selection based on the current cursor location.

### ■ Using Comments in Macros

Comments are notes to be ignored when running the macro commands. Macro supports both single-line comments and block comments. Single-line comments begin with two forward slashes (//) and run to the end of the line.

The following is an example of a macro command followed by a single-line comment.

```
IF $U0.0 (B) // Key Down
```

Block comments begin with an opening delimiter (/\*) and run to a closing delimiter (\*). Comments do not nest.

The following is an example of a block comment.

```
/* $N1001=WH2021
   $N1010=$N1001 */
```

### ■ Specifying Constants in Macros

To specify a hexadecimal number, use either the h or H suffix. For example, 12abH and 3ABh are valid hexadecimal numbers. You can also use either the "0x" or "0X" prefix. For example, 0x1278abc and 0XFFFF0000 are valid hexadecimal numbers.

To specify a binary number, use either b or B suffix. For example, 001100111b and 11110000B are valid binary numbers.

For decimal numbers, in most cases, you just type the numbers as they are to specify the constants. However, the ambiguity exists when a constant is the same as a valid external variable. For example, if a panel application has a link to a Modicon ModBus slave device, it is impossible to tell whether the number 40001 is a constant or a word address of the controller. To avoid this kind of ambiguity, use the following methods to explicitly declare that a number is a constant:

- 1) Use K, k, D, or d suffix for an integer number. For example, -123K and -123d are valid specifications of constant -123.
- 2) Use either the f or F suffix for a decimal number with decimal point. For example, -12.3F and -12.3f are valid specifications of constant -12.3.





### 14.3.2. Macro Command Properties Tool Window

The Macro Command Properties Tool Window help you add and modify a macro command quickly and easily.

If you open a macro from Project Manager or Menu Item, the Macro Properties Tool Window will be opened as a docking window. You can easily configure the dockable tool window to show or hide automatically or tab link with other tool windows or dock against the edges, or float over. When the Macro Editor is opened, you can also choose to open or close the Macro Command Properties Tool Window by clicking the [Macro Command Properties] menu item under [View] menu.

If you open the macro from object's configuration dialog box, the Macro Properties Tool Window will float besides the Macro Editor and it can be moved to anywhere but can't be closed.

The following table describes each property in the macro command properties tool window.

Property		Description
Command		Clicks the dropdown list box to bring up the macro command selection dialog, In the dialog, navigates the keyword of macro commands through tabs and sections by moving the mouse and then clicks the selection. The format of the selected macro command will be shown in the dropdown list after the dialog is closed. To cancel the operation, click anywhere outside the macro command selection dialog.
Data Type		Selects the data type for the macro command from the dropdown list. Different macro command supports different data types. The supported data types for each macro command are some of the followings: <b>(S)</b> 16-bit Signed, <b>(U)</b> 16-bit Unsigned, <b>(SD)</b> 32-bit Signed, <b>(UD)</b> 32-bit Unsigned, <b>(F)</b> 32-bit Floating Point, <b>(B)</b> Bit.
Parameter	<Edit Box>	Specifies the bit variable when the Data Type is <b>(B)</b> . Specifies the word variable when the Data Type is <b>(U)/(S)</b> . Specifies the double-word variable when the Data Type is <b>(UD)/(SD)/(F)</b> .
		Clicks this icon to bring up the Address Input Keypad and specify the desired address for the Variable field.
		Clicks this icon to bring up the Select Tag dialog box and select the desired tag for the Variable field.
Macro Command Help		Shows the operation, parameter type of the selected macro command.

Note that any modification in the dialog will change the current macro command in the Macro Editor.



## 14.4. Macro Commands and Examples

### 14.4.1. Macro Notations and Terminology

The following notations and terminology will be used in the Macro Commands and Examples sections.

#### ■ Notations

- 1) *P1, P2, P3, P4, P5*: Parameters of macro commands.
- 2) *I, E, C, A, CS, M, AE, CE*: Used for indicating the types of parameter a macro command can accept for a specific command parameter.

Abbreviation	Parameter Type
I	Internal Variable
E	External Variable
C	Constant
A	ASCII character string
CS	Character string of the program label
M	Sub-macro name
AE	Arithmetic expression
CE	Comparison expression

- 3) *U, S, UD, SD, F, B*: Used for indicating the types of data a macro command can support.

Abbreviation	Data Type
U	16-bit Unsigned Integer
S	16-bit Signed Integer
UD	32-bit Unsigned Integer
SD	32-bit Signed Integer
F	32-bit Floating Point
B	Bit

#### ■ Terminology

Terminology	Definition
Internal memory	The memory space in the PM Designer that can be accessed by the panel application. For example, the user memory \$U, the non-volatile memory \$N, the system memory \$S, and the recipe memory \$R are all parts of the internal memory.
Internal variable	An address or a tag referring to an address of a space in the internal memory.
Internal bit variable	An internal variable that refers to a bit in the internal memory. For easy to read, we usually use “internal variable” instead of “internal bit variable” when referring to a bit if there is no ambiguity.
Internal word variable	An internal variable that refers to a word in the internal memory. The variables can also be used to refer to a double-word, a block of bytes (byte array), a block of words (word array), and a block of double-words (double-word array). For easy to read, we usually use “internal variable” instead of “internal word variable” when referring to a word or a block of memory space if there is no ambiguity.
External memory	The memory spaces or the collections of addressable devices in the controllers that can be accessed by the panel application through communication links.

Continued



Terminology	Definition																																																																																
External variable	An address or a tag referring to an address of a space in the external memory.																																																																																
External bit variable	An external variable that refers to a bit in the external memory. For easy to read, we usually use “external variable” instead of “external bit variable” when referring to a bit if there is no ambiguity.																																																																																
External word variable	An external variable that refers to a word in the external memory. The variables can also be used to refer to a double-word, a block of bytes (byte array), a block of words (word array), and a block of double-words (double-word array) if the access unit of the associated addresses is word. If the access unit is double-word, you can only use the variable to refer to a double-word or a block of memory space with a length of a multiple of 4 (bytes). For easy to read, we usually use “external variable” instead of “external word variable” when referring to a word or a block of memory space if there is no ambiguity.																																																																																
Expression	<table border="1"> <thead> <tr> <th>Type</th> <th>Abbreviation</th> <th>Description</th> </tr> </thead> <tbody> <tr> <td>Arithmetic Expression</td> <td>AE</td> <td>Sequences of operators and parameters that are used for computing a value from the parameters.</td> </tr> <tr> <td>Comparison Expression</td> <td>CE</td> <td>Sequences of operators and parameters that are used for comparing value from the parameters.</td> </tr> </tbody> </table> <p>PM Designer provides the following types of operators for macro expressions:</p> <table border="1"> <thead> <tr> <th>Operators</th> <th>Name or Meaning</th> <th>Grouping</th> <th>Used for</th> </tr> </thead> <tbody> <tr> <td>( )</td> <td>Parentheses</td> <td>Left to right</td> <td>AE/CE</td> </tr> <tr> <td>*</td> <td>Multiplication</td> <td>Left to right</td> <td rowspan="7">AE</td> </tr> <tr> <td>/</td> <td>Division</td> <td>Left to right</td> </tr> <tr> <td>%</td> <td>Modulus</td> <td>Left to right</td> </tr> <tr> <td>+</td> <td>Addition</td> <td>Left to right</td> </tr> <tr> <td>-</td> <td>Subtraction</td> <td>Left to right</td> </tr> <tr> <td>&lt;&lt;</td> <td>Left shift</td> <td>Left to right</td> </tr> <tr> <td>&gt;&gt;</td> <td>Right shift</td> <td>Left to right</td> </tr> <tr> <td>&lt;</td> <td>Less than</td> <td>Left to right</td> <td rowspan="6">CE</td> </tr> <tr> <td>&gt;</td> <td>Greater than</td> <td>Left to right</td> </tr> <tr> <td>&lt;=</td> <td>Less than or equal to</td> <td>Left to right</td> </tr> <tr> <td>&gt;=</td> <td>Greater than or equal to</td> <td>Left to right</td> </tr> <tr> <td>==</td> <td>Equality</td> <td>Left to right</td> </tr> <tr> <td>!=</td> <td>Inequality</td> <td>Left to right</td> </tr> <tr> <td>&amp;</td> <td>Bitwise AND</td> <td>Left to right</td> <td rowspan="3">AE</td> </tr> <tr> <td>^</td> <td>Bitwise exclusive OR</td> <td>Left to right</td> </tr> <tr> <td> </td> <td>Bitwise inclusive OR</td> <td>Left to right</td> </tr> <tr> <td>&amp;&amp;</td> <td>Logical AND</td> <td>Left to right</td> <td>CE</td> </tr> <tr> <td>  </td> <td>Logical OR</td> <td>Left to right</td> <td>CE</td> </tr> <tr> <td>=</td> <td>Assignment</td> <td>Right to left</td> <td>AE/CE</td> </tr> </tbody> </table> <p><b>Note:</b> The above table lists the operators in order of precedence (from highest to lowest precedence). Operators in the same segment of the table have equal precedence and are evaluated in the given order in an expression unless explicitly forced by parentheses.</p>	Type	Abbreviation	Description	Arithmetic Expression	AE	Sequences of operators and parameters that are used for computing a value from the parameters.	Comparison Expression	CE	Sequences of operators and parameters that are used for comparing value from the parameters.	Operators	Name or Meaning	Grouping	Used for	( )	Parentheses	Left to right	AE/CE	*	Multiplication	Left to right	AE	/	Division	Left to right	%	Modulus	Left to right	+	Addition	Left to right	-	Subtraction	Left to right	<<	Left shift	Left to right	>>	Right shift	Left to right	<	Less than	Left to right	CE	>	Greater than	Left to right	<=	Less than or equal to	Left to right	>=	Greater than or equal to	Left to right	==	Equality	Left to right	!=	Inequality	Left to right	&	Bitwise AND	Left to right	AE	^	Bitwise exclusive OR	Left to right		Bitwise inclusive OR	Left to right	&&	Logical AND	Left to right	CE		Logical OR	Left to right	CE	=	Assignment	Right to left	AE/CE
Type	Abbreviation	Description																																																																															
Arithmetic Expression	AE	Sequences of operators and parameters that are used for computing a value from the parameters.																																																																															
Comparison Expression	CE	Sequences of operators and parameters that are used for comparing value from the parameters.																																																																															
Operators	Name or Meaning	Grouping	Used for																																																																														
( )	Parentheses	Left to right	AE/CE																																																																														
*	Multiplication	Left to right	AE																																																																														
/	Division	Left to right																																																																															
%	Modulus	Left to right																																																																															
+	Addition	Left to right																																																																															
-	Subtraction	Left to right																																																																															
<<	Left shift	Left to right																																																																															
>>	Right shift	Left to right																																																																															
<	Less than	Left to right	CE																																																																														
>	Greater than	Left to right																																																																															
<=	Less than or equal to	Left to right																																																																															
>=	Greater than or equal to	Left to right																																																																															
==	Equality	Left to right																																																																															
!=	Inequality	Left to right																																																																															
&	Bitwise AND	Left to right	AE																																																																														
^	Bitwise exclusive OR	Left to right																																																																															
	Bitwise inclusive OR	Left to right																																																																															
&&	Logical AND	Left to right	CE																																																																														
	Logical OR	Left to right	CE																																																																														
=	Assignment	Right to left	AE/CE																																																																														



### 14.4.2. Data Transfer

#### Assignment (=)

Format	$P1 = P2$	Data Type	U/S/UD/SD/F/B
Function	Assigns the value of $P2$ to $P1$ .		
$P1$ (I/E)	The destination.		
$P2$ (I/E/C/AE)	The source.		
Example 1	$\$U2 = 123.45$ (F) /* Assign 123.45 to \$U2 (and \$U3) */		
Example 2	$\$U100.f = 1$ (B) /* Turn on the specified bit */		
Example 3	$W60 = (\$U30 + \$W50 - 1000) / 2$ (SD) /* Write the result of the arithmetic expression to W60. */		
Example 4	$V0.0 = 2\backslash M0$ (B) /* Assign the bit value of M0 of link 2 to the bit V0.0 of link 1*/		

#### Logical NOT (= !)

Format	$P1 = ! P2$	Data Type	B
Function	Reverses $P2$ and saves the result in $P1$ .		
$P1$ (I/E)	The location to save the result.		
$P2$ (I/E)	The operand.		
Example 1	$\$U2.3 = !\$U3.4$ (B) /* If \$U3.4 is 1 (On), \$U2.3 is 0 (Off) */		

" "

Format	$P1 = "P2"$
Function	Copies the quoted ASCII character string $P2$ to $P1$ . Note that the string is a null terminated string. If the length of the string is N then N+1 bytes will be copied to $P1$ and the last byte is 0.
$P1$ (I)	The location to save the result.
$P2$ (A)	The quoted ASCII character string.
Example 1	$\$U60 = "TEST"$ /* The null character (00h) will be moved to the low byte of \$U62 */
Example 2	$\$U20 = "ABCDE"$ /* The null character (00h) will be moved to the high byte of \$U22 */

#### MOV

Format	$P1 = MOV(P2,P3)$	Data Type	U
Function	Copies $P3$ words of $P2$ to $P1$ .		
$P1$ (I/E)	The starting location of the memory to receive the copy.		
$P2$ (I/E)	The starting location of the memory to be copied.		
$P3$ (I/C)	The number of words to be copied.		
Example 1	$\$U100 = MOV(\$U200, 16)$ /* Copy the 16 words starting from \$U200 to \$U100 */		
Example 2	$W60 = MOV(\$U200, \$U2)$ /* Copy the word array starting from \$U200 with the size specified in \$U2 to W60.*/		
Example 3	$\$U10 = MOV(2\backslash D100,10)$ /* Copy D100 ~ D109 of link 2 to \$U10 ~ \$U19.*/		





## SETM

<b>Format</b>	$P1 = SETM(P2, P3)$	<b>Data Type</b>	U
<b>Function</b>	Sets $P3$ words of $P1$ to word value $P2$ .		
$P1$ (I/E)	The starting location of the memory to be set.		
$P2$ (I/C)	The set value or the location that holds the set value.		
$P3$ (I/C)	The number of words to be set.		
<b>Example 1</b>	$\$U100 = SETM(0, 16)$ /* Set the 16 words starting from $\$U100$ to 0. */		
<b>Example 2</b>	$W60 = SETM(\$U200, \$U2)$ /* Set the words of the word array starting from $W60$ with the size specified in $\$U2$ to the value of $\$U200$ .*/		

## 14.4.3. Arithmetic Operation

## Addition ( + )

<b>Format</b>	$P1 = P2 + P3$	<b>Data Type</b>	U/S/UD/SD/F
<b>Function</b>	Adds $P2$ and $P3$ and saves the result in $P1$ .		
$P1$ (I/E)	The location to save the result.		
$P2, P3$ (I/E/C/AE)	The operands.		
<b>Example 1</b>	$\$U100 = \$U101 + \$U102$ (U)		
<b>Example 2</b>	$W100 = 0.3*\$U0 + 0.1*\$U2 + 0.6*\$U4$ (F)		

## Subtraction ( - )

<b>Format</b>	$P1 = P2 - P3$	<b>Data Type</b>	U/S/UD/SD/F
<b>Function</b>	Subtracts $P3$ from $P2$ and saves the result in $P1$ .		
$P1$ (I/E)	The location to save the result.		
$P2, P3$ (I/E/C/AE)	The operands.		
<b>Example 1</b>	$\$U100 = \$U101 - \$U102$ (U)		
<b>Example 2</b>	$W100 = 0.3*\$U0 - 10.75$ (F)		

## Multiplication ( \* )

<b>Format</b>	$P1 = P2 * P3$	<b>Data Type</b>	U/S/UD/SD/F
<b>Function</b>	Multiplies $P2$ by $P3$ and saves the product in $P1$ .		
$P1$ (I/E)	The location to save the product. If the product is overflow, the higher bits exceeding the limit will be truncated and the remaining bits will be stored in $P1$ .		
$P2, P3$ (I/E/C/AE)	The operands.		
<b>Example 1</b>	$\$U100 = \$U102 * 0x192$		
<b>Example 2</b>	$W100 = (\$U0 + \$U2) * (\$U4 + \$U6)$ (F)		





## Division ( / )

<b>Format</b>	$P1 = P2 / P3$	<b>Data Type</b>	U/S/UD/SD/F
<b>Function</b>	Divides <b>P2</b> by <b>P3</b> and saves the quotient in <b>P1</b> .		
<b>P1 (I/E)</b>	The location to save the result.		
<b>P2,P3 (I/E/C/AE)</b>	The operands.		
<b>Example 1</b>	$\$U100 = \$U101 / \$U102$ (U)		
<b>Example 2</b>	$W100 = (\$U0 + \$U2) / (\$U4 + \$U6)$ (F)		

## Modulus ( % )

<b>Format</b>	$P1 = P2 \% P3$	<b>Data Type</b>	U/S/UD/SD
<b>Function</b>	Divides <b>P2</b> by <b>P3</b> and saves the remainder in <b>P1</b> .		
<b>P1 (I/E)</b>	The location to save the result.		
<b>P2,P3 (I/E/C/AE)</b>	The operands.		
<b>Example 1</b>	$\$U100 = \$U30 \% 16$ (U)		
<b>Example 2</b>	$W100 = \$U200 \% (\$U402 + \$U106)$ (SD)		

## 14.4.4. Logical Operation

## Bitwise Inclusive OR ( | )

<b>Format</b>	$P1 = P2   P3$	<b>Data Type</b>	U/UD/B
<b>Function</b>	Performs bitwise Inclusive OR operation of <b>P2</b> and <b>P3</b> and saves the results in <b>P1</b> .		
<b>P1 (I/E)</b>	The location to save the result.		
<b>P2,P3 (I/E/C)</b>	The operands		
<b>Example 1</b>	$W60 = 1111000000001111b$ $\$U100 = 0000111100001111b   W60$ (U) /* The value of \$U100 is 1111111100001111b */		
<b>Example 2</b>	$B15 = \$U1.2   B14$ (B) /* If either \$U1.2 or B14 has a value of 1(On), B15 has the value 1(On). Otherwise, B15 has the value 0(Off)*/		

## Bitwise AND ( &amp; )

<b>Format</b>	$P1 = P2 \& P3$	<b>Data Type</b>	U/UD/B
<b>Function</b>	Performs bitwise AND operation of <b>P2</b> and <b>P3</b> and saves the results in <b>P1</b> .		
<b>P1 (I/E)</b>	The location to save the result.		
<b>P2,P3 (I/E/C)</b>	The operands		
<b>Example 1</b>	$W60 = 1111000000001111b$ $\$U100 = 0000111100001111b \& W60$ (U) /* The value of \$U100 is 0000000000001111b */		
<b>Example 2</b>	$B15 = \$U1.2 \& B14$ (B) /* If both \$U1.2 and B14 are 1(On), B15 is set to 1(On). Otherwise B15 is set to 0(Off) */		



## Bitwise Exclusive OR ( ^ )

Format	$P1 = P2 \wedge P3$	Data Type	U/UD/B
Function	Performs bitwise Exclusive OR operation of $P2$ and $P3$ and saves the results in $P1$ .		
$P1$ (I/E)	The location to save the result.		
$P2, P3$ (I/E/C)	The operands		
Example 1	$W60 = 1111000000001111b$ $\$U100 = 0000111100001111b \wedge W60$ (U) /* The value of $\$U100$ is 1111111100000000b.*/		
Example 2	$B15 = \$U1.2 \wedge B14$ (B) /*If both $\$U1.2$ and $B14$ are 1(On) or 0(Off), the $B15$ is set to 0(Off). Otherwise $B15$ is set to 1(On)*/		

## Left Shift ( &lt;&lt; )

Format	$P1 = P2 \ll P3$	Data Type	U/UD
Function	Shifts $P2$ to the left by $P3$ bits and saves the results in $P1$ . The operation supports the logic shift only.		
$P1$ (I/E)	The location to save the result.		
$P2$ (I/E/C)	The value or the location that holds the value to be shifted.		
$P3$ (I/E/C)	The number of bits to be shifted.		
Example 1	$\$U100 = \$U101 \ll 8$ (U)		
Example 2	$W200 = W100 \ll \$U10$ (UD)		

## Right Shift ( &gt;&gt; )

Format	$P1 = P2 \gg P3$	Data Type	U/UD
Function	Shifts $P2$ to the right by $P3$ bits and saves the results in $P1$ . The operation supports the logic shift only.		
$P1$ (I/E)	The location to save the result.		
$P2$ (I/E/C)	The value or the location that holds the value to be shifted.		
$P3$ (I/E/C)	The number of bits to be shifted.		
Example 1	$\$U100 = \$U101 \gg 8$ (U)		
Example 2	$W200 = W100 \gg \$U10$ (UD)		

## Logical AND ( &amp;&amp; )

Format	$P1 = P2 \&\& P3$	Data Type	B
Function	Saves 1 in $P1$ if both $P2$ and $P3$ are 1, otherwise saves 0 in $P1$ .		
$P1$ (I/E)	The bit to save the result.		
$P2, P3$ (I/E/C)	The operands.		
Example 1	$\$U100.0 = \$U101.0 \&\& \$U101.1$ (B)		



## Logical OR ( || )

<b>Format</b>	$P1 = P2 \text{    } P3$	<b>Data Type</b>	B
<b>Function</b>	Saves 1 in <i>P1</i> if either or both <i>P2</i> and <i>P3</i> are 1, otherwise saves 0 in <i>P1</i> .		
<i>P1</i> (I/E)	The bit to save the result.		
<i>P2,P3</i> (I/E/C)	The operands.		
<b>Example 1</b>	$\$U100.0 = \$U101.0 \text{    } \$U101.1$ (B)		

## 14.4.5. Calculation

## MAX

<b>Format</b>	$P1 = \text{MAX}(P2,P3)$	<b>Data Type</b>	U/S/UD/SD/F
<b>Function</b>	Sets <i>P1</i> to the larger value of <i>P2</i> and <i>P3</i> .		
<i>P1</i> (I/E)	The location to save the result.		
<i>P2,P3</i> (I/E/C)	The operands.		
<b>Example 1</b>	$\$U100 = \text{MAX}(100, 200) /* \text{ Set } \$U100 \text{ to } 200 */$		

## MIN

<b>Format</b>	$P1 = \text{MIN}(P2,P3)$	<b>Data Type</b>	U/S/UD/SD/F
<b>Function</b>	Sets <i>P1</i> to the smaller value of <i>P2</i> and <i>P3</i> .		
<i>P1</i> (I/E)	The location to save the result.		
<i>P2,P3</i> (I/E/C)	The operands.		
<b>Example 1</b>	$\$U100 = \text{MIN}(100, 200) /* \text{ Set } \$U100 \text{ to } 100 */$		

## BMAX

<b>Format</b>	$P1 = \text{BMAX}(P2,P3)$	<b>Data Type</b>	U/S/UD/SD/F
<b>Function</b>	Finds the maximum in an array starting from <i>P2</i> with <i>P3</i> elements and saves the result in <i>P1</i> .		
<i>P1</i> (I)	The location to save the result.		
<i>P2</i> (I)	The starting location of the array.		
<i>P3</i> (I/C)	The size of the array.		
<b>Example 1</b>	$\$U100 = \text{BMAX}(\$U200, 16)$ (F) /* Find the maximum among 16 floating point numbers starting from \$U200 and save the result in \$U100 */		

## BMIN

<b>Format</b>	$P1 = \text{BMIN}(P2,P3)$	<b>Data Type</b>	U/S/UD/SD/F
<b>Function</b>	Finds the minimum in an array starting from <i>P2</i> with <i>P3</i> elements and saves the result in <i>P1</i> .		
<i>P1</i> (I)	The location to save the result.		
<i>P2</i> (I)	The starting location of the array.		
<i>P3</i> (I/C)	The size of the array.		
<b>Example 1</b>	$\$U100 = \text{BMIN}(\$U200, 60)$ (F) /* Find the minimum among 60 floating point numbers starting from \$U200 and save the result in \$U100 */		



## SUM

Format	$P1 = \text{SUM}(P2, P3)$	Data Type	U/S/UD/SD/F
Function	Calculates the sum of the value in an array starting from $P2$ with $P3$ elements and saves the result in $P1$ .		
$P1$ (I)	The location to save the result.		
$P2$ (I)	The starting location of the array.		
$P3$ (I/C)	The size of the array.		
Example 1	$\$U100 = \text{SUM}(\$U200, 16)$ (F) /* Calculate the sum of 16 floating point numbers starting from \$U200 and save the result in \$U100 */		

## XSUM

Format	$P1 = \text{XSUM}(P2, P3)$	Data Type	U/UD
Function	Calculates one element XOR (Bitwise Exclusive OR) sum of all the $P3$ elements in an array starting from $P2$ and saves the result in $P1$ .		
$P1$ (I)	The location to save the result.		
$P2$ (I)	The starting location of the array.		
$P3$ (I/C)	The size of the array.		
Example 1	$\$U100 = \text{XSUM}(\$U200, 5)$ (UD) /* Perform XOR sum of 5 32-bit unsigned numbers starting from \$U200 and save the result in \$U100. Another expression of XOR sum is $\$U100 = \$U200 \wedge \$U202 \wedge \$U204 \wedge \$U206 \wedge \$U208$ (UD) */  $\$U100 = 1001\text{B}$ $\$U101 = 1100\text{B}$ $\$U102 = 0110\text{B}$ $\$U120 = \text{XSUM}(\$U100, 3)$ /* \$U120=0011B */		

## SWAP

Format	$\text{SWAP}(P1, P2)$	Data Type	U
Function	Swaps the low byte and high byte of every word in a word array starting from $P1$ with $P2$ words.		
$P1$ (I)	The starting location of the array.		
$P2$ (I/C)	The size of the array.		
Example 1	$\$U120 = 1111111100000000\text{B}$ $\$U121 = 1000000100000000\text{B}$ $\text{SWAP}(\$U120, 2)$ /* The value of \$U120 will be 0000000011111111B, The value of \$U121 will be 000000010000001B */		



### 14.4.6. Data Conversion

#### BCD

Format	$P1 = \text{BCD}(P2)$	Data Type	U/UD
Function	Converts binary number $P2$ to a BCD number and saves the result in $P1$ .		
$P1$ (I/E)	The location to save the result.		
$P2$ (I/E/C)	The binary number to be converted.		
Example 1	$\$U100 = \text{BCD}(0x1234) (U) /*$ The value of $\$U100$ will be 1234. $*/$		

#### BIN

Format	$P1 = \text{BIN}(P2)$	Data Type	U/UD
Function	Converts BCD number $P2$ to a binary number and saves the result in $P1$ .		
$P1$ (I/E)	The location to save the result.		
$P2$ (I/E/C)	The BCD number to be converted.		
Example 1	$\$U100 = \text{BIN}(1234) (U) /*$ The value of $\$U100$ will be 0x1234. $*/$		

#### DW

Format	$P1 = \text{DW}(P2)$	Data Type	U/S
Function	Converts 16-bit number $P2$ to a 32-bit number and saves the result in $P1$ .		
$P1$ (I/E)	The location to save the result.		
$P2$ (I/E/C)	The 16-bit number to be converted.		
Example 1	$\$U100 = \text{DW}(12345) (S) /*$ The value of $\$U100$ will be 12345 and the value of $\$U101$ will be 0. $*/$		
Example 2	$\$U200 = \text{DW}(-12345) (S) /*$ The value of $\$U200$ will be -12345 and the value of $\$U201$ will be 0xFFFF. $*/$		

#### W

Format	$P1 = \text{W}(P2)$	Data Type	UD/SD
Function	Converts 32-bit number $P2$ to a 16-bit number and saves the result in $P1$ . The truncation error may occur.		
$P1$ (I/E)	The location to save the result.		
$P2$ (I/E/C)	The 32-bit number to be converted.		
Example 1	$\$U100 = \text{W}(0x12345678) (UD) /*$ The value of $\$U100$ will be 0x5678 $*/$		
Example 2	$\$U200 = \text{W}(-12345) (SD) /*$ The value of $\$U200$ will be -12345 $*/$		



## B2W

Format	$P1 = B2W(P2,P3)$	Data Type	U
Function	Converts $P3$ -byte array starting from $P2$ to a $P3$ -word array and saves the result in $P1$ . All the high bytes of the word array are set to 0.		
$P1$ (I)	The location (or the word array) to save the result.		
$P2$ (I)	The byte array to be converted.		
$P3$ (I/C)	The size of the byte array.		
Example 1	<pre> \$U200 = 0x45FA \$U201 = 0xEB29 \$U100 = B2W(\$U200, 3) /* Convert 3 bytes starting from \$U200 to 3 words starting from \$U100, \$U100 will be 0xFA, \$U101 will be 0x45 and \$U102 will be 0x29. */ </pre>		

## W2B

Format	$P1 = W2B(P2,P3)$	Data Type	U
Function	Converts a word array $P2$ with $P3$ elements to a byte array and saves the result in the byte array $P1$ . The conversion discards the high byte of every element of the word array to form a byte array with the same number of elements. The array size can not exceed 256.		
$P1$ (I)	The location (or the word array) to save the result.		
$P2$ (I)	The word array to be converted.		
$P3$ (I/C)	The size of the word array.		
Example 1	<pre> \$U200 = 0x45FA \$U201 = 0xEB29 \$U202 = 0xC781 \$U100 = W2B(\$U200, 3) /* Convert 3 words starting from \$U200 to 3 bytes starting from \$U100, \$U100 will be 0x29FA and the low byte of \$U101 will be 0x81*/ </pre>		

## A2X

Format	$P1 = A2X(P2)$	Data Type	U
Function	Converts a 4-digit hex number in ASCII character form to a binary number and saves the result in $P1$ . The character of the fourth digit is in the first word of the word array $P2$ and the characters of the other digits are in the following words in sequence.		
$P1$ (I)	The location to save the result.		
$P2$ (I)	The word array that contains the characters to be converted.		
Example 1	<pre> \$U20 = 49 // '1' \$U21 = 50 // '2' \$U22 = 69 // 'E' \$U23 = 70 // 'F' \$U100 = A2X(\$U20) /* The value of \$U100 will be 0x12EF. */ </pre>		



## X2A

Format	$P1 = X2A(P2)$	Data Type	U
Function	Converts 16-bit number $P2$ to a 4-digit hex number in ASCII character form and saves the result in word array $P1$ . The character of the fourth digit is saved in the first word of $P1$ and the characters of the other digits are saved in the following words in sequence.		
$P1$ (I)	The location (or the word array) to save the result.		
$P2$ (I/C)	The number to be converted.		
Example 1	$\$U10 = X2A(0x34AB)$ /*The 4 words starting from $\$U10$ will be: 51('3'), 52('4'), 65('A'), 66('B') */		

## W2F

Format	$P1 = W2F(P2)$	Data Type	U/S
Function	Converts 16-bit number $P2$ to a floating point number and saves the result in $P1$ .		
$P1$ (I/E)	The location to save the result.		
$P2$ (I/E/C)	The 16-bit number to be converted.		
Example 1	$\$U200 = W2F(\$U10)$ (S)		

## D2F

Format	$P1 = D2F(P2)$	Data Type	UD/SD
Function	Converts 32-bit number $P2$ to a floating point number and saves the result in $P1$ .		
$P1$ (I/E)	The location to save the result.		
$P2$ (I/E/C)	The 32-bit number to be converted.		
Example 1	$\$U200 = D2F(\$U10)$ (SD)		

## F2W

Format	$P1 = F2W(P2)$	Data Type	F
Function	Converts floating point number $P2$ to a 16-bit number and saves the result in $P1$ .		
$P1$ (I/E)	The location to save the result.		
$P2$ (I/E/C)	The floating point number to be converted.		
Example 1	$\$U200 = F2W(\$U10)$ (F)		

## F2D

Format	$P1 = F2D(P2)$	Data Type	F
Function	Converts floating point number $P2$ to a 32-bit number and saves the result in $P1$ .		
$P1$ (I/E)	The location to save the result.		
$P2$ (I/E/C)	The floating point number to be converted.		
Example 1	$\$U200 = F2D(\$U10)$ (F)		



## EXTRACT\_BIT

Format	$P1 = \text{EXTRACT\_BIT}(P2,P3)$	Data Type	U/UD
Function	Extracts bit $P3$ from $P2$ and saves the result in $P1$ .		
$P1$ (I)	The bit to save the result.		
$P2$ (I)	The location to extract the bit.		
$P3$ (I/C)	The number of the bit to be extracted.		
Example 1	$\$U2.0 = \text{EXTRACT\_BIT}(\$U10, 31)$ (UD) /* Extract bit 31 of the double word \$U10 and save the result in \$U2.0 */		

## 14.4.7. Conditional Operation

## IF ==

Format	$\text{IF } P2 == P3$	Data Type	U/S/UD/SD/F
Function	Executes the commands in the command block following this IF command when $P2$ is equal to $P3$ .		
$P2,P3$ (I/E/C/AE)	The operands.		

## IF !=

Format	$\text{IF } P2 != P3$	Data Type	U/S/UD/SD/F
Function	Executes the commands in the command block following this IF command when $P2$ is not equal to $P3$ .		
$P2,P3$ (I/E/C/AE)	The operands.		

## IF &gt;

Format	$\text{IF } P2 > P3$	Data Type	U/S/UD/SD/F
Function	Executes the commands in the command block following this IF command when $P2$ is greater than $P3$ .		
$P2,P3$ (I/E/C/AE)	The operands.		

## IF &gt;=

Format	$\text{IF } P2 >= P3$	Data Type	U/S/UD/SD/F
Function	Executes the commands in the command block following this IF command when $P2$ is greater than or equal to $P3$ .		
$P2,P3$ (I/E/C/AE)	The operands.		

## IF &lt;

Format	$\text{IF } P2 < P3$	Data Type	U/S/UD/SD/F
Function	Executes the commands in the command block following this IF command when $P2$ is less than $P3$ .		
$P2,P3$ (I/E/C/AE)	The operands.		





## IF &lt;=

<b>Format</b>	<b>IF <math>P2 \leq P3</math></b>	<b>Data Type</b>	<b>U/S/UD/SD/F</b>
<b>Function</b>	Executes the commands in the command block following this IF command when $P2$ is less than or equal to $P3$ .		
$P2, P3$ (I/E/C/AE)	The operands.		

## IF &amp;

<b>Format</b>	<b>IF <math>P2 \&amp; P3</math></b>	<b>Data Type</b>	<b>U/UD</b>
<b>Function</b>	Executes the commands in the command block following this IF command when the result of Bitwise AND between $P2$ and $P3$ is non-zero.		
$P2, P3$ (I/E/C/AE)	The operands.		

## IF !&amp;

<b>Format</b>	<b>IF <math>!(P2 \&amp; P3)</math></b>	<b>Data Type</b>	<b>U/UD</b>
<b>Function</b>	Executes the commands in the command block following this IF command when the result of Bitwise AND between $P2$ and $P3$ is zero.		
$P2, P3$ (I/E/C/AE)	The operands.		

## IF &lt;bit&gt;

<b>Format</b>	<b>IF <math>P2</math></b>	<b>Data Type</b>	<b>B</b>
<b>Function</b>	Executes the commands in the command block following this IF command if the condition $P2$ is true (1/On).		
$P2$ (I/E/CE)	The condition.		

## IF !&lt;bit&gt;

<b>Format</b>	<b>IF <math>!P2</math></b>	<b>Data Type</b>	<b>B</b>
<b>Function</b>	Executes the commands in the command block following this IF command if the condition $P2$ is false (0/Off).		
$P2$ (I/E/CE)	The condition.		

## ELIF ==

<b>Format</b>	<b>ELIF <math>P2 == P3</math></b>	<b>Data Type</b>	<b>U/S/UD/SD/F</b>
<b>Function</b>	Executes the commands in the command block following this ELIF command when $P2$ is equal to $P3$ .		
$P2, P3$ (I/E/C/AE)	The operands.		

## ELIF !=

<b>Format</b>	<b>ELIF <math>P2 \neq P3</math></b>	<b>Data Type</b>	<b>U/S/UD/SD/F</b>
<b>Function</b>	Executes the commands in the command block following this ELIF command when $P2$ is not equal to $P3$ .		
$P2, P3$ (I/E/C/AE)	The operands.		



## ELIF &gt;

<b>Format</b>	<b>ELIF <math>P2 &gt; P3</math></b>	<b>Data Type</b>	<b>U/S/UD/SD/F</b>
<b>Function</b>	Executes the commands in the command block following this ELIF command when $P2$ is greater than $P3$ .		
$P2, P3$ (I/E/C/AE)	The operands.		

## ELIF &gt;=

<b>Format</b>	<b>ELIF <math>P2 \geq P3</math></b>	<b>Data Type</b>	<b>U/S/UD/SD/F</b>
<b>Function</b>	Executes the commands in the command block following this ELIF command when $P2$ is greater than or equal to $P3$ .		
$P2, P3$ (I/E/C/AE)	The operands.		

## ELIF &lt;

<b>Format</b>	<b>ELIF <math>P2 &lt; P3</math></b>	<b>Data Type</b>	<b>U/S/UD/SD/F</b>
<b>Function</b>	Executes the commands in the command block following this ELIF command when $P2$ is less than $P3$ .		
$P2, P3$ (I/E/C/AE)	The operands.		

## ELIF &lt;=

<b>Format</b>	<b>ELIF <math>P2 \leq P3</math></b>	<b>Data Type</b>	<b>U/S/UD/SD/F</b>
<b>Function</b>	Executes the commands in the command block following this ELIF command when $P2$ is less than or equal to $P3$ .		
$P2, P3$ (I/E/C/AE)	The operands.		

## ELIF &amp;

<b>Format</b>	<b>ELIF <math>P2 \&amp; P3</math></b>	<b>Data Type</b>	<b>U/UD</b>
<b>Function</b>	Executes the commands in the command block following this ELIF command when the result of Bitwise AND between $P2$ and $P3$ is non-zero.		
$P2, P3$ (I/E/C/AE)	The operands.		

## ELIF !&amp;

<b>Format</b>	<b>ELIF <math>!(P2 \&amp; P3)</math></b>	<b>Data Type</b>	<b>U/UD</b>
<b>Function</b>	Executes the commands in the command block following this ELIF command when the result of Bitwise AND between $P2$ and $P3$ is zero.		
$P2, P3$ (I/E/C/AE)	The operands.		

## ELIF &lt;bit&gt;

<b>Format</b>	<b>ELIF <math>P2</math></b>	<b>Data Type</b>	<b>B</b>
<b>Function</b>	Executes the commands in the command block following this ELIF command if the condition $P2$ is true (1/On).		
$P2$ (I/E/CE)	The condition.		

**ELIF !<bit>**

<b>Format</b>	<b>ELIF !P2</b>	<b>Data Type</b>	<b>B</b>
<b>Function</b>	Executes the commands in the command block following this ELIF command if the condition <b>P2</b> is false (0/Off).		
<b>P2 (I/E/CE)</b>	The condition.		

**ELSE**

<b>Format</b>	<b>ELSE</b>
<b>Function</b>	This command specifies the begin of the default command block that will be executed if none of the conditions in the preceding IF and/or ELIF commands is true. This is not an executable command.

**ENDIF**

<b>Format</b>	<b>ENDIF</b>										
<b>Function</b>	This command specifies the end of a command block, which begins at the command following the matching IF, ELIF, or ELSE command. This is not an executable command.										
<b>Example</b>	<p><b>IF-Command Structures:</b></p> <table border="1"> <thead> <tr> <th>Commands and Structures</th> <th>Description</th> </tr> </thead> <tbody> <tr> <td>IF &lt;condition&gt; ... ENDIF</td> <td>Runs the command block between IF and ENDIF when the condition is true, otherwise ignores the command block.</td> </tr> <tr> <td>IF &lt;condition&gt; ... ELSE ... ENDIF</td> <td>Runs the command block between IF and ELSE when the condition is true, otherwise runs the command block between ELSE and ENDIF.</td> </tr> <tr> <td>IF &lt;condition&gt; ... ELIF &lt;condition_2&gt; ... ELIF &lt;condition_3&gt; . . . ELIF &lt;condition_N&gt; ... ENDIF</td> <td>Runs the command block between IF and the first ELIF and ignores all the following commands in the structure when condition 1 is true, otherwise examines condition 2. Runs the command block between the first ELIF and the second ELIF and ignores all the following commands in the structure when condition 2 is true, otherwise checks condition 3. Repeats the same operation until condition N is processed. If none of the conditions are true, no command block in this structure is run.</td> </tr> <tr> <td>IF &lt;condition&gt; ... ELIF &lt;condition_2&gt; ... ELIF &lt;condition_3&gt; . . . ELIF &lt;condition_N&gt; ... ELSE ... ENDIF</td> <td>Runs the command block between IF and the first ELIF and ignores all the following commands in the structure when condition 1 is true, otherwise examines condition 2. Runs the commands block between the first ELIF and the second ELIF and ignores all the following commands in the structure when condition 2 is true, otherwise checks condition 3. Repeats the same operation until condition N is processed. Runs the command block between ELSE and ENDIF if none of the conditions are true.</td> </tr> </tbody> </table> <p><b>Note</b> that there can be up to 20 nested IF-command structures.</p>	Commands and Structures	Description	IF <condition> ... ENDIF	Runs the command block between IF and ENDIF when the condition is true, otherwise ignores the command block.	IF <condition> ... ELSE ... ENDIF	Runs the command block between IF and ELSE when the condition is true, otherwise runs the command block between ELSE and ENDIF.	IF <condition> ... ELIF <condition_2> ... ELIF <condition_3> . . . ELIF <condition_N> ... ENDIF	Runs the command block between IF and the first ELIF and ignores all the following commands in the structure when condition 1 is true, otherwise examines condition 2. Runs the command block between the first ELIF and the second ELIF and ignores all the following commands in the structure when condition 2 is true, otherwise checks condition 3. Repeats the same operation until condition N is processed. If none of the conditions are true, no command block in this structure is run.	IF <condition> ... ELIF <condition_2> ... ELIF <condition_3> . . . ELIF <condition_N> ... ELSE ... ENDIF	Runs the command block between IF and the first ELIF and ignores all the following commands in the structure when condition 1 is true, otherwise examines condition 2. Runs the commands block between the first ELIF and the second ELIF and ignores all the following commands in the structure when condition 2 is true, otherwise checks condition 3. Repeats the same operation until condition N is processed. Runs the command block between ELSE and ENDIF if none of the conditions are true.
Commands and Structures	Description										
IF <condition> ... ENDIF	Runs the command block between IF and ENDIF when the condition is true, otherwise ignores the command block.										
IF <condition> ... ELSE ... ENDIF	Runs the command block between IF and ELSE when the condition is true, otherwise runs the command block between ELSE and ENDIF.										
IF <condition> ... ELIF <condition_2> ... ELIF <condition_3> . . . ELIF <condition_N> ... ENDIF	Runs the command block between IF and the first ELIF and ignores all the following commands in the structure when condition 1 is true, otherwise examines condition 2. Runs the command block between the first ELIF and the second ELIF and ignores all the following commands in the structure when condition 2 is true, otherwise checks condition 3. Repeats the same operation until condition N is processed. If none of the conditions are true, no command block in this structure is run.										
IF <condition> ... ELIF <condition_2> ... ELIF <condition_3> . . . ELIF <condition_N> ... ELSE ... ENDIF	Runs the command block between IF and the first ELIF and ignores all the following commands in the structure when condition 1 is true, otherwise examines condition 2. Runs the commands block between the first ELIF and the second ELIF and ignores all the following commands in the structure when condition 2 is true, otherwise checks condition 3. Repeats the same operation until condition N is processed. Runs the command block between ELSE and ENDIF if none of the conditions are true.										



### 14.4.8. Program Control

#### JMP

<b>Format</b>	<b>JMP <i>P1</i></b>
<b>Function</b>	Unconditionally jumps to the program point specified by label <i>P1</i> .
<b><i>P1</i> (CS)</b>	The label of the program point.
<b>Example 1</b>	<pre>IF \$U10 == 0     JMP SKIP /* Skip the command "\$U20 = \$U10 / 2". */ ENDIF \$U20 = \$U10 / 2 SKIP: \$U10 = 1</pre>

#### <label>

<b>Format</b>	<b><i>P1</i>:</b>
<b>Function</b>	This is not an executable command. The <i>P1</i> is the label of the program point where it is positioned.
<b><i>P1</i> (CS)</b>	The character string as the label of the program point. Remember to have the character ':' after the label.
<b>Example 1</b>	<pre>IF \$U10 == 0     JMP SKIP /* Skip the command "\$U20 = \$U10 / 2" */ ENDIF \$U20 = \$U10 / 2 SKIP: \$U10 = 1</pre>

#### JMP ==

Format	JMP( <i>P1</i> , <i>P2</i> == <i>P3</i> )	Data Type	U/S/UD/SD/F
<b>Function</b>	Jumps to the program point specified by label <i>P1</i> when <i>P2</i> is equal to <i>P3</i> .		
<b><i>P1</i> (CS)</b>	The label of the program point.		
<b><i>P2</i>,<i>P3</i> (I/E/C/AE)</b>	The operands.		

#### JMP !=

Format	JMP( <i>P1</i> , <i>P2</i> != <i>P3</i> )	Data Type	U/S/UD/SD/F
<b>Function</b>	Jumps to the program point specified by label <i>P1</i> when <i>P2</i> is not equal to <i>P3</i> .		
<b><i>P1</i> (CS)</b>	The label of the program point.		
<b><i>P2</i>,<i>P3</i> (I/E/C/AE)</b>	The operands.		

#### JMP >

Format	JMP( <i>P1</i> , <i>P2</i> > <i>P3</i> )	Data Type	U/S/UD/SD/F
<b>Function</b>	Jumps to the program point specified by label <i>P1</i> when <i>P2</i> is greater than <i>P3</i> .		
<b><i>P1</i> (CS)</b>	The label of the program point.		
<b><i>P2</i>,<i>P3</i> (I/E/C/AE)</b>	The operands.		

**JMP >=**

<b>Format</b>	<b>JMP(P1,P2 &gt;= P3)</b>	<b>Data Type</b>	<b>U/S/UD/SD/F</b>
<b>Function</b>	Jumps to the program point specified by label <b>P1</b> when <b>P2</b> is greater than or equal to <b>P3</b> .		
<b>P1</b> (CS)	The label of the program point.		
<b>P2,P3</b> (I/E/C/AE)	The operands.		

**JMP <**

<b>Format</b>	<b>JMP(P1,P2 &lt; P3)</b>	<b>Data Type</b>	<b>U/S/UD/SD/F</b>
<b>Function</b>	Jumps to the program point specified by label <b>P1</b> when <b>P2</b> is less than <b>P3</b> .		
<b>P1</b> (CS)	The label of the program point.		
<b>P2,P3</b> (I/E/C/AE)	The operands.		

**JMP <=**

<b>Format</b>	<b>JMP(P1,P2 &lt;= P3)</b>	<b>Data Type</b>	<b>U/S/UD/SD/F</b>
<b>Function</b>	Jumps to the program point specified by label <b>P1</b> when <b>P2</b> is less than or equal to <b>P3</b> .		
<b>P1</b> (CS)	The label of the program point.		
<b>P2,P3</b> (I/E/C/AE)	The operands.		

**JMP &**

<b>Format</b>	<b>JMP(P1,P2 &amp; P3)</b>	<b>Data Type</b>	<b>U/UD</b>
<b>Function</b>	Jumps to the program point specified by label <b>P1</b> when the result of Bitwise AND between <b>P2</b> and <b>P3</b> is non-zero.		
<b>P1</b> (CS)	The label of the program point.		
<b>P2,P3</b> (I/E/C/AE)	The operands.		

**JMP !&**

<b>Format</b>	<b>JMP(P1,!(P2 &amp; P3))</b>	<b>Data Type</b>	<b>U/UD</b>
<b>Function</b>	Jumps to the program point specified by label <b>P1</b> when the result of Bitwise AND between <b>P2</b> and <b>P3</b> is zero.		
<b>P1</b> (CS)	The label of the program point.		
<b>P2,P3</b> (I/E/C/AE)	The operands.		

**JMP <bit>**

<b>Format</b>	<b>JMP(P1,P2)</b>	<b>Data Type</b>	<b>B</b>
<b>Function</b>	Jumps to the program point specified by label <b>P1</b> if the condition <b>P2</b> is true (1/On).		
<b>P1</b> (CS)	The label of the program point.		
<b>P2,P3</b> (I/E/CE)	The operands.		



## JMP !&lt;bit&gt;

<b>Format</b>	<b>JMP(P1,!P2)</b>	<b>Data Type</b>	<b>B</b>
<b>Function</b>	Jumps to the program point specified by label <b>P1</b> if the condition <b>P2</b> is false (0/Off).		
<b>P1 (CS)</b>	The label of the program point.		
<b>P2,P3 (I/E/CE)</b>	The operands.		

## CALL

<b>Format</b>	<b>CALL P1</b>
<b>Function</b>	Goes to sub-macro <b>P1</b> .
<b>P1 (Sub-macro name)</b>	The sub-macro to be called.
<b>Example 1</b>	CALL CommonFunction_01 /* Go to sub-macro named CommonFuncation_01 */

## RET

<b>Format</b>	<b>RET</b>
<b>Function</b>	Returns to the calling macro. This command can only be used in sub-macros.

## FOR

<b>Format</b>	<b>FOR P2</b>	<b>Data Type</b>	<b>U</b>
<b>Function</b>	Runs the commands within the FOR loop by <b>P1</b> times. A FOR loop is enclosed by a matching pair of FOR and NEXT commands. There can be up to 20 nested FOR loops.		
<b>P1 (I/C)</b>	Total times to run the FOR loop		
<b>Example 1</b>	<pre>FOR 10     \$U100 = \$U100 + 1 /* This command will be executed 10 times */ FOR 12     \$U200 = \$U200 + 1 /* This command will be executed 120 times */ NEXT NEXT</pre>		

## NEXT

<b>Format</b>	<b>NEXT</b>
<b>Function</b>	This command indicates the end of a FOR loop. It is not an executable command.
<b>Example 1</b>	<p><b>Example:</b></p> <pre>\$U1 = 10 \$U2 = 12 FOR \$U1     \$U100 = \$U100 + 1 /* This command will be executed 10 times. */ FOR \$U2     \$U200 = \$U200 + 1 /* This command will be executed 120 times. */ NEXT NEXT</pre>

**STOP**

<b>Format</b>	<b>STOP</b>
<b>Function</b>	Stops the macro immediately. If the macro is a Cycle macro, it will be run again starting from the first command when the associated window is opened again. If the macro is Main macro, it will be run again starting from the first command when restarting the application.  This command can not be used in sub-macros.

**END**

<b>Format</b>	<b>END</b>
<b>Function</b>	Indicates the end of macro and stops the macro in the current cycle. It can be put anywhere in a macro to stop the macro at any point. If the macro is a cyclic macro, such as the Main macro and the Cycle macros, it is stopped just in the current cycle and will be run again starting from the first command in the next cycle.  This command can not be used in sub-macros.

**14.4.9. Timer Operation****SET\_T**

<b>Format</b>	<b>SET_T(P1,P2)</b>	<b>Data Type</b>	<b>U</b>															
<b>Function</b>	Starts the timer <b>P1</b> using the timer control block in <b>P2</b> .																	
<b>P1 (C)</b>	The ID of the timer. There are 8 timers available and the IDs are 0 to 7.																	
<b>P2 (l)</b>	The starting location of the memory block (or word array) that is used as a Timer Control Block for the timer. The structure of the Timer Control Block is shown below:																	
	<table border="1"> <thead> <tr> <th>Word No.</th> <th>Data Item</th> <th>Description</th> </tr> </thead> <tbody> <tr> <td>0</td> <td>Type of operation</td> <td>0: One-shot; 1: Square-wave</td> </tr> <tr> <td>1</td> <td>Current timer value</td> <td>The timer increases the value of this word by 1 every 100ms.</td> </tr> <tr> <td>2</td> <td>Timer limit</td> <td>When the current timer value reaches the timer limit, the timer will perform one of the following operations according to the type of operation: 1) If the type of operation is One-shot (0), sets the time-up flag to 1, resets the current timer value to 0, and stops itself. 2) If the type of operation is Square-wave (1), toggles the time-up flag, resets the current timer value to 0, and continues the timing operation.</td> </tr> <tr> <td>3</td> <td>Time-up flag</td> <td>This word will be set to 0 or 1 when the current timer value is equal to the timer limit.</td> </tr> </tbody> </table>	Word No.	Data Item	Description	0	Type of operation	0: One-shot; 1: Square-wave	1	Current timer value	The timer increases the value of this word by 1 every 100ms.	2	Timer limit	When the current timer value reaches the timer limit, the timer will perform one of the following operations according to the type of operation: 1) If the type of operation is One-shot (0), sets the time-up flag to 1, resets the current timer value to 0, and stops itself. 2) If the type of operation is Square-wave (1), toggles the time-up flag, resets the current timer value to 0, and continues the timing operation.	3	Time-up flag	This word will be set to 0 or 1 when the current timer value is equal to the timer limit.		
Word No.	Data Item	Description																
0	Type of operation	0: One-shot; 1: Square-wave																
1	Current timer value	The timer increases the value of this word by 1 every 100ms.																
2	Timer limit	When the current timer value reaches the timer limit, the timer will perform one of the following operations according to the type of operation: 1) If the type of operation is One-shot (0), sets the time-up flag to 1, resets the current timer value to 0, and stops itself. 2) If the type of operation is Square-wave (1), toggles the time-up flag, resets the current timer value to 0, and continues the timing operation.																
3	Time-up flag	This word will be set to 0 or 1 when the current timer value is equal to the timer limit.																
	The timer will use the associated Timer Control Block as its private memory, so do not use any words in the block for other purposes. A Timer Control Block requires 4 words.																	
<b>Example 1</b>	<pre> \$U100 = 1 /* Type of operation is Square-wave. */ \$U101 = 0 /* Initialize the current timer value to 0. */ \$U102 = 5 /* Timer limit is 0.5 second (5*100ms). */ \$U103 = 0 /* Initialize the time-up flag to 0. */ SET_T(3, \$U100) /* Use timer #3 to generate a 1 Hz square wave on \$U103.0 */ </pre>																	



## STOP\_T

<b>Format</b>	<b>STOP_T(P1)</b>	<b>Data Type</b>	<b>U</b>
<b>Function</b>	Stops the timer <i>P1</i> .		
<b>P1 (C)</b>	The ID of the timer.		
<b>Example 1</b>	STOP_T(1) /* Stop timer #1 */		

## WAIT\_T

<b>Format</b>	<b>WAIT_T(P1)</b>	<b>Data Type</b>	<b>U</b>
<b>Function</b>	Waits for the time-up of timer <i>P1</i> . The macro command following this one will not be executed until the timer reaches its limit.		
<b>P1 (C)</b>	The ID of the timer.		
<b>Example 1</b>	<pre> \$U100 = 0 /* Type of operation is One-shot. */ \$U101 = 0 /* Initialize the current timer value to 0. */ \$U102 = 5 /* Timer limit is 0.5 second (5*100ms). */ \$U103 = 0 /* Initialize the time-up flag to 0. */ SET_T(7, \$U100) /* Starts timer #7 as a 0.5 second timer. */ WAIT_T(7) /* Wait 0.5 second */ </pre>		

## 14.4.10. Keypad Operation

## KB\_MCR

<b>Format</b>	<b>KB_MCR(P1)</b>	<b>Data Type</b>	<b>U</b>
<b>Function</b>	Accepts or ignores the character/command currently input by the associated keypad button. This command must be used only in a macro that is run by a keypad button. A keypad button runs the specified macro when it is pressed. You can use this command in a keypad button macro to accept or ignore the current input of that button.		
<b>P1 (I/C)</b>	The value or the location that holds the value to determine the acceptance of the keypad button input. If the value is 0, the input will be accepted; Otherwise the input will be ignored.		
<b>Example 1</b>	KB_MCR(1) /* Ignore the current input */		

## KPD\_TEXT

<b>Format</b>	<b>KPD_TEXT(P1)</b>	<b>Data Type</b>	<b>U</b>
<b>Function</b>	The memory block (or byte array) that contains the null-terminated ASCII character string to be used to initialize the keypad display and buffer.		
<b>P1 (I)</b>	The memory block (or byte array) that contains the null-terminated ASCII character string to be used to initialize the keypad display and buffer.		
<b>Example 1</b>	<pre> \$U100 = "initial text" KPD_TEXT(\$U100) /* Initialize the keypad display and buffer using the string "initial text". */ </pre>		





### 14.4.11. Recipe Operation

#### RB2ROM

Format	<i>P1</i> = RB2ROM( <i>P2</i> )	Data Type	U
Function	Saves the data of recipe block <i>P2</i> to the flash ROM and saves the completion code in <i>P1</i> .		
<i>P1</i> (I)	The word to receive the completion code. If the completion code is 0, the operation succeeded; Otherwise the operation failed.		
<i>P2</i> (I/C)	The ID of the recipe block to be saved. The option "Need space in flash ROM to save backup" must be selected for the recipe block.		
Example 1	\$U10 = RB2ROM(3) /* Save recipe block #3 to the flash ROM. */		

#### ROM2RB

Format	<i>P1</i> = ROM2RB( <i>P2</i> )	Data Type	U
Function	Restores the data of recipe block <i>P2</i> from the flash ROM and saves the completion code in <i>P1</i> .		
<i>P1</i> (I)	The word to receive the completion code. If the completion code is 0, the operation succeeded; Otherwise the operation failed.		
<i>P2</i> (I/C)	The ID of the recipe block to be restored. The option "Need space in flash ROM to save backup" must be selected for the recipe block.		
Example 1	\$U10 = ROM2RB(3) /* Restore recipe block #3 from the flash ROM. */		

#### REF\_RCP\_OBJ

Format	REF_RCP_OBJ( <i>P1</i> )	Data Type	U
Function	Refreshes the recipe objects associated with the specified recipe block <i>P1</i> . The recipe objects include recipe selectors and recipe tables. You can use this command to update the display of associated objects after changing the data of a recipe block in a macro program.		
<i>P1</i> (I/C)	The ID of the associated recipe block.		
Example 1	REF_RCP_OBJ(3) /* Refresh the recipe objects associated with recipe block #3 */		



## 14.4.12. Communication Operation

### EN\_LINK

Format	EN_LINK( <i>P1,P2,P3</i> )	Data Type	U
Function	Enables communication link <i>P1</i> or sub-link <i>P2</i> of communication link <i>P1</i> when <i>P3</i> is 1. Disables the specified communication link or sub-link when <i>P3</i> is 0.		
<i>P1</i> (I/C)	The number of the communication link to be enabled or disabled.		
<i>P2</i> (I/C)	The node address of the sub-link to be enabled or disabled. If the specified communication link has no sub-link, this parameter is ignored. If the specified communication link has sub-links and you want to enable or disable the link itself, set this parameter to 0.		
<i>P3</i> (I/C)	To enable the specified communication link or sub-link, set this parameter to 1. To disable the specified communication link or sub-link, set this parameter to 0.		
Example 1	ENABLE_LINK(1, 20, 0) /* Disable the sub-link, whose node address is 20, of communication link 1. */		

### LINK\_STS

Format	<i>P1</i> = LINK_STS( <i>P2,P3</i> )	Data Type	U																																																												
Function	Gets the status of communication link <i>P2</i> or the sub-link <i>P3</i> of communication link <i>P2</i> and saves the result in <i>P1</i> .																																																														
<i>P1</i> (I/C)	The word to receive the status of the specified communication link or sub-link. The status is a 16-bit value. The following table lists the meaning of each status value.																																																														
	<table border="1"> <thead> <tr> <th>Status Value</th> <th>Meaning</th> <th>Status Value</th> <th>Meaning</th> </tr> </thead> <tbody> <tr> <td>0</td> <td>OK</td> <td>14</td> <td>Device busy</td> </tr> <tr> <td>1</td> <td>Overflow error</td> <td>15</td> <td>Unknown error</td> </tr> <tr> <td>2</td> <td>Break error</td> <td>16</td> <td>Link disabled</td> </tr> <tr> <td>3</td> <td>Parity error</td> <td>17</td> <td>Initialization failure</td> </tr> <tr> <td>4</td> <td>Framing error</td> <td>18</td> <td>Failed to send data</td> </tr> <tr> <td>5</td> <td>No response</td> <td>19</td> <td>Failed to receive data</td> </tr> <tr> <td>6</td> <td>Unrecognized response</td> <td>20</td> <td>Failed to open connection</td> </tr> <tr> <td>7</td> <td>Timeout</td> <td>21</td> <td>Connection not ready</td> </tr> <tr> <td>8</td> <td>Inactive CTS</td> <td>22</td> <td>Invalid sub-link</td> </tr> <tr> <td>9</td> <td>Checksum error</td> <td>23</td> <td>Invalid COM port</td> </tr> <tr> <td>10</td> <td>Command rejected</td> <td>24</td> <td>Error</td> </tr> <tr> <td>11</td> <td>Invalid address</td> <td>255</td> <td>Condition uncertain</td> </tr> <tr> <td>12</td> <td>Invalid range</td> <td>65535</td> <td>Failed to get status</td> </tr> <tr> <td>13</td> <td>Invalid request</td> <td></td> <td></td> </tr> </tbody> </table>			Status Value	Meaning	Status Value	Meaning	0	OK	14	Device busy	1	Overflow error	15	Unknown error	2	Break error	16	Link disabled	3	Parity error	17	Initialization failure	4	Framing error	18	Failed to send data	5	No response	19	Failed to receive data	6	Unrecognized response	20	Failed to open connection	7	Timeout	21	Connection not ready	8	Inactive CTS	22	Invalid sub-link	9	Checksum error	23	Invalid COM port	10	Command rejected	24	Error	11	Invalid address	255	Condition uncertain	12	Invalid range	65535	Failed to get status	13	Invalid request		
Status Value	Meaning	Status Value	Meaning																																																												
0	OK	14	Device busy																																																												
1	Overflow error	15	Unknown error																																																												
2	Break error	16	Link disabled																																																												
3	Parity error	17	Initialization failure																																																												
4	Framing error	18	Failed to send data																																																												
5	No response	19	Failed to receive data																																																												
6	Unrecognized response	20	Failed to open connection																																																												
7	Timeout	21	Connection not ready																																																												
8	Inactive CTS	22	Invalid sub-link																																																												
9	Checksum error	23	Invalid COM port																																																												
10	Command rejected	24	Error																																																												
11	Invalid address	255	Condition uncertain																																																												
12	Invalid range	65535	Failed to get status																																																												
13	Invalid request																																																														
<i>P2</i> (I/C)	The number of the communication link.																																																														
<i>P3</i> (I/C)	The node address of the sub-link. If the specified communication link has no sub-link, this parameter is ignored.																																																														
Example 1	\$U100 = LINK_STS(2, 0) /* Get the status of communication link 2 and save it to \$U100. */																																																														
Example 2	\$U12 = LINK_STS(1, 128) /* Get the status of the sub-link, whose node address is 128, of communication link 1 and save it to \$U12. */																																																														



## 14.4.13. System Service

## GET\_RTC

Format	GET_RTC( <i>P1</i> )	Data Type	U																											
<b>Function</b>	Gets the data of the real time clock and saves the result in <i>P1</i> .																													
<i>P1</i> (I)	<p>The starting location of the memory block that is used as an RTC data block to receive the operation result. The structure of the RTC data block is shown below:</p> <table border="1"> <thead> <tr> <th>Data Item</th> <th>Data Type/Size</th> <th>Word No.</th> </tr> </thead> <tbody> <tr> <td>Second</td> <td>16-bit Unsigned Integer</td> <td>0</td> </tr> <tr> <td>Minute</td> <td>16-bit Unsigned Integer</td> <td>1</td> </tr> <tr> <td>Hour</td> <td>16-bit Unsigned Integer</td> <td>2</td> </tr> <tr> <td>RTC adjustment</td> <td>16-bit Signed Integer</td> <td>3</td> </tr> <tr> <td>Day</td> <td>16-bit Unsigned Integer</td> <td>4</td> </tr> <tr> <td>Month</td> <td>16-bit Unsigned Integer</td> <td>5</td> </tr> <tr> <td>Year</td> <td>16-bit Unsigned Integer</td> <td>6</td> </tr> <tr> <td>Day of week</td> <td>16-bit Unsigned Integer</td> <td>7</td> </tr> </tbody> </table> <p>Second: 0~59; Minute: 0~59; Hour: 0~23; RTC adjustment: -63~63; Day: 1~31; Month: 1~12; Year: 0(2000)~99(2099); Day of week: 0(Sunday)~6(Saturday) An RTC data block requires 8 words.</p>			Data Item	Data Type/Size	Word No.	Second	16-bit Unsigned Integer	0	Minute	16-bit Unsigned Integer	1	Hour	16-bit Unsigned Integer	2	RTC adjustment	16-bit Signed Integer	3	Day	16-bit Unsigned Integer	4	Month	16-bit Unsigned Integer	5	Year	16-bit Unsigned Integer	6	Day of week	16-bit Unsigned Integer	7
Data Item	Data Type/Size	Word No.																												
Second	16-bit Unsigned Integer	0																												
Minute	16-bit Unsigned Integer	1																												
Hour	16-bit Unsigned Integer	2																												
RTC adjustment	16-bit Signed Integer	3																												
Day	16-bit Unsigned Integer	4																												
Month	16-bit Unsigned Integer	5																												
Year	16-bit Unsigned Integer	6																												
Day of week	16-bit Unsigned Integer	7																												
<b>Example 1</b>	GET_RTC(\$U100) /* Get the data of the real time clock. The second will be in \$U100 and the day-of-week will be in \$U107. */																													

## SET\_RTC

Format	SET_RTC( <i>P1</i> )	Data Type	U
<b>Function</b>	Sets the real time clock using the data in <i>P1</i> .		
<i>P1</i> (I)	The starting location of the memory block that is used as an RTC data block to contain the new settings for the real time clock. See the description of <a href="#">GET_RTC</a> to know the structure of the RTC data block.		
<b>Example 1</b>	<pre> \$U100 = 0 // Second \$U101 = 30 // Minute \$U102 = 8 // Hour \$U103 = 0 // Adjustment \$U104 = 1 // Day \$U105 = 7 // July \$U106 = 10 // Year 2010 \$U107 = 4 // Thursday SET_RTC(\$U100) /* Set the real time clock to 8:30:00 July 1st 2010 Thursday */ </pre>		

## SYS

Format	SYS( <i>P1,P2,P3</i> )	Data Type	U
<b>Function</b>	Requests system service <i>P1</i> with the arguments <i>P2</i> and <i>P3</i> . This command is reserved for system use.		
<i>P1</i> (I)	The code of the system service.		
<i>P2,P3</i> (I/C)	The arguments of the system service.		



#### 14.4.14. Screen Operation

##### OPEN\_WS

Format	OPEN_WS <i>P1</i>	Data Type	U
Function	The number of the window screen to be opened. This command will not open the specified screen if it is a normal screen or menu screen. The macro commands following this command will not be executed until the opened window screen is closed. Also, when a screen's Cycle macro is waiting for the closing of the window screen opened by this command, that screen can not be closed or switched by any means.		
<i>P1</i> (I/C)	The number of the window screen to be opened. If the screen number indicates to normal screen or menu screen, no screen will be opened.		

##### CLOSE\_WS

Format	CLOSE_WS
Function	Closes the window screen that was opened by the macro command OPEN_WS.



## 14.4.15. File Operation

## FILE\_IO

Format	<i>P1</i> = FILE_IO( <i>P2</i> , <i>P3</i> )	Data Type	U																																																																								
<b>Function</b>	Performs the file operation specified by <i>P2</i> and <i>P3</i> using <a href="#">default filename</a> and saves the completion code in <i>P1</i> .																																																																										
<i>P1</i> (I)	The word to receive the completion code of the operation. If the completion code is 0, the operation succeeded; otherwise the operation failed.																																																																										
<i>P2</i> , <i>P3</i> (I/C)	<p><i>P2</i> specifies the type of file operation. <i>P3</i> specifies the ID of the data source. The following table describes how to set <i>P2</i> and <i>P3</i>.</p> <table border="1"> <thead> <tr> <th>File Operation</th> <th><i>P2</i></th> <th><i>P3</i></th> </tr> </thead> <tbody> <tr> <td>Save Logged Data (.txt)</td> <td>1</td> <td>Data logger ID (0~15)</td> </tr> <tr> <td>Save Logged Alarms (.txt)</td> <td>2</td> <td>0</td> </tr> <tr> <td>Save Alarm Counts (.txt)</td> <td>3</td> <td>0</td> </tr> <tr> <td>Save Recipe Data (.txt)</td> <td>4</td> <td>Recipe block ID (0~15)</td> </tr> <tr> <td>Save Recipe Data (.prd)</td> <td>5</td> <td>Recipe block ID (0~15)</td> </tr> <tr> <td>Print Screen to File (256-color .bmp)</td> <td>6</td> <td>Screen number (1~7999)</td> </tr> <tr> <td>Print Screen to File (64K-color .bmp)</td> <td>7</td> <td>Screen number (1~7999)</td> </tr> <tr> <td>Save Logged Operations (.txt)</td> <td>9</td> <td>0</td> </tr> <tr> <td>Save Logged Data (.ldf)</td> <td>10</td> <td>Data logger ID (0~15)</td> </tr> <tr> <td>Take Picture (.bmp)</td> <td>12</td> <td>USB camera ID (0~3)</td> </tr> <tr> <td>Take Picture (.jpg)</td> <td>13</td> <td>USB camera ID (0~3)</td> </tr> </tbody> </table> <p>Default Filename:</p> <table border="1"> <thead> <tr> <th>File Operation</th> <th>Filename Format</th> <th>Remark</th> </tr> </thead> <tbody> <tr> <td>Save Logged Data (.txt)</td> <td>DL&lt;ID&gt;_&lt;Date&gt;_&lt;Time&gt;.txt</td> <td>&lt;ID&gt;: Data logger ID</td> </tr> <tr> <td>Save Logged Alarms (.txt)</td> <td>AL_&lt;Date&gt;_&lt;Time&gt;.txt</td> <td></td> </tr> <tr> <td>Save Alarm Counts (.txt)</td> <td>AC_&lt;Date&gt;_&lt;Time&gt;.txt</td> <td></td> </tr> <tr> <td>Save Recipe Data (.txt)</td> <td>RB&lt;ID&gt;.txt</td> <td>&lt;ID&gt;: Recipe block ID</td> </tr> <tr> <td>Save Recipe Data (.prd)</td> <td>RB&lt;ID&gt;.prd</td> <td>&lt;ID&gt;: Recipe block ID</td> </tr> <tr> <td>Print Screen to File (256-color .bmp)</td> <td>S&lt;ID&gt;_&lt;Date&gt;_&lt;Time&gt;.bmp</td> <td>&lt;ID&gt;: Screen number</td> </tr> <tr> <td>Print Screen to File (64K-color .bmp)</td> <td>S&lt;ID&gt;_&lt;Date&gt;_&lt;Time&gt;.bmp</td> <td>&lt;ID&gt;: Screen number</td> </tr> <tr> <td>Save Logged Operations (.txt)</td> <td>OL_&lt;Date&gt;_&lt;Time&gt;.txt</td> <td></td> </tr> <tr> <td>Save Logged Data (.ldf)</td> <td>DL&lt;ID&gt;_&lt;Date&gt;_&lt;Time&gt;.ldf</td> <td>&lt;ID&gt;: Data logger ID</td> </tr> <tr> <td>Take Picture (.bmp)</td> <td>CAM&lt;ID&gt;_&lt;Date&gt;_&lt;Time&gt;.bmp</td> <td>USB camera ID</td> </tr> <tr> <td>Take Picture (.jpg)</td> <td>CAM&lt;ID&gt;_&lt;Date&gt;_&lt;Time&gt;.jpg</td> <td>USB camera ID</td> </tr> </tbody> </table> <p><b>Note:</b>            &lt;Date&gt;: The date when saving the data.            &lt;Time&gt;: The time when saving the data.            You can select the formats of &lt;Date&gt; and &lt;Time&gt; on the Custom page in the General Setup dialog box.</p>			File Operation	<i>P2</i>	<i>P3</i>	Save Logged Data (.txt)	1	Data logger ID (0~15)	Save Logged Alarms (.txt)	2	0	Save Alarm Counts (.txt)	3	0	Save Recipe Data (.txt)	4	Recipe block ID (0~15)	Save Recipe Data (.prd)	5	Recipe block ID (0~15)	Print Screen to File (256-color .bmp)	6	Screen number (1~7999)	Print Screen to File (64K-color .bmp)	7	Screen number (1~7999)	Save Logged Operations (.txt)	9	0	Save Logged Data (.ldf)	10	Data logger ID (0~15)	Take Picture (.bmp)	12	USB camera ID (0~3)	Take Picture (.jpg)	13	USB camera ID (0~3)	File Operation	Filename Format	Remark	Save Logged Data (.txt)	DL<ID>_<Date>_<Time>.txt	<ID>: Data logger ID	Save Logged Alarms (.txt)	AL_<Date>_<Time>.txt		Save Alarm Counts (.txt)	AC_<Date>_<Time>.txt		Save Recipe Data (.txt)	RB<ID>.txt	<ID>: Recipe block ID	Save Recipe Data (.prd)	RB<ID>.prd	<ID>: Recipe block ID	Print Screen to File (256-color .bmp)	S<ID>_<Date>_<Time>.bmp	<ID>: Screen number	Print Screen to File (64K-color .bmp)	S<ID>_<Date>_<Time>.bmp	<ID>: Screen number	Save Logged Operations (.txt)	OL_<Date>_<Time>.txt		Save Logged Data (.ldf)	DL<ID>_<Date>_<Time>.ldf	<ID>: Data logger ID	Take Picture (.bmp)	CAM<ID>_<Date>_<Time>.bmp	USB camera ID	Take Picture (.jpg)	CAM<ID>_<Date>_<Time>.jpg	USB camera ID
File Operation	<i>P2</i>	<i>P3</i>																																																																									
Save Logged Data (.txt)	1	Data logger ID (0~15)																																																																									
Save Logged Alarms (.txt)	2	0																																																																									
Save Alarm Counts (.txt)	3	0																																																																									
Save Recipe Data (.txt)	4	Recipe block ID (0~15)																																																																									
Save Recipe Data (.prd)	5	Recipe block ID (0~15)																																																																									
Print Screen to File (256-color .bmp)	6	Screen number (1~7999)																																																																									
Print Screen to File (64K-color .bmp)	7	Screen number (1~7999)																																																																									
Save Logged Operations (.txt)	9	0																																																																									
Save Logged Data (.ldf)	10	Data logger ID (0~15)																																																																									
Take Picture (.bmp)	12	USB camera ID (0~3)																																																																									
Take Picture (.jpg)	13	USB camera ID (0~3)																																																																									
File Operation	Filename Format	Remark																																																																									
Save Logged Data (.txt)	DL<ID>_<Date>_<Time>.txt	<ID>: Data logger ID																																																																									
Save Logged Alarms (.txt)	AL_<Date>_<Time>.txt																																																																										
Save Alarm Counts (.txt)	AC_<Date>_<Time>.txt																																																																										
Save Recipe Data (.txt)	RB<ID>.txt	<ID>: Recipe block ID																																																																									
Save Recipe Data (.prd)	RB<ID>.prd	<ID>: Recipe block ID																																																																									
Print Screen to File (256-color .bmp)	S<ID>_<Date>_<Time>.bmp	<ID>: Screen number																																																																									
Print Screen to File (64K-color .bmp)	S<ID>_<Date>_<Time>.bmp	<ID>: Screen number																																																																									
Save Logged Operations (.txt)	OL_<Date>_<Time>.txt																																																																										
Save Logged Data (.ldf)	DL<ID>_<Date>_<Time>.ldf	<ID>: Data logger ID																																																																									
Take Picture (.bmp)	CAM<ID>_<Date>_<Time>.bmp	USB camera ID																																																																									
Take Picture (.jpg)	CAM<ID>_<Date>_<Time>.jpg	USB camera ID																																																																									



## FILE\_IO\_N

Format	$P1 = \text{FILE\_IO\_N}(P2, P3, P4)$	Data Type	U																																				
Function	Performs the file operation specified by $P2$ and $P3$ using filename $P4$ and saves the completion code in $P1$ .																																						
$P1$ (I)	The word to receive the completion code of the operation. If the completion code is 0, the operation succeeded; otherwise the operation failed.																																						
$P2, P3$ (I/C)	<p><math>P2</math> specifies the type of file operation. <math>P3</math> specifies the ID of the data source. The following table describes how to set <math>P2</math> and <math>P3</math>.</p> <table border="1"> <thead> <tr> <th>File Operation</th> <th><math>P2</math></th> <th><math>P3</math></th> </tr> </thead> <tbody> <tr> <td>Save Logged Data (.txt)</td> <td>31</td> <td>Data logger ID (0~15)</td> </tr> <tr> <td>Save Logged Alarms (.txt)</td> <td>32</td> <td>0</td> </tr> <tr> <td>Save Alarm Counts (.txt)</td> <td>33</td> <td>0</td> </tr> <tr> <td>Save Recipe Data (.txt)</td> <td>34</td> <td>Recipe block ID (0~15)</td> </tr> <tr> <td>Save Recipe Data (.prd)</td> <td>35</td> <td>Recipe block ID (0~15)</td> </tr> <tr> <td>Print Screen to File (256-color .bmp)</td> <td>36</td> <td>Screen number (1~7999)</td> </tr> <tr> <td>Print Screen to File (64K-color .bmp)</td> <td>37</td> <td>Screen number (1~7999)</td> </tr> <tr> <td>Save Logged Operations (.txt)</td> <td>39</td> <td>0</td> </tr> <tr> <td>Save Logged Data (.ldf)</td> <td>40</td> <td>Data logger ID (0~15)</td> </tr> <tr> <td>Take Picture (.bmp)</td> <td>42</td> <td>USB camera ID (0~3)</td> </tr> <tr> <td>Take Picture (.jpg)</td> <td>43</td> <td>USB camera ID (0~3)</td> </tr> </tbody> </table>			File Operation	$P2$	$P3$	Save Logged Data (.txt)	31	Data logger ID (0~15)	Save Logged Alarms (.txt)	32	0	Save Alarm Counts (.txt)	33	0	Save Recipe Data (.txt)	34	Recipe block ID (0~15)	Save Recipe Data (.prd)	35	Recipe block ID (0~15)	Print Screen to File (256-color .bmp)	36	Screen number (1~7999)	Print Screen to File (64K-color .bmp)	37	Screen number (1~7999)	Save Logged Operations (.txt)	39	0	Save Logged Data (.ldf)	40	Data logger ID (0~15)	Take Picture (.bmp)	42	USB camera ID (0~3)	Take Picture (.jpg)	43	USB camera ID (0~3)
File Operation	$P2$	$P3$																																					
Save Logged Data (.txt)	31	Data logger ID (0~15)																																					
Save Logged Alarms (.txt)	32	0																																					
Save Alarm Counts (.txt)	33	0																																					
Save Recipe Data (.txt)	34	Recipe block ID (0~15)																																					
Save Recipe Data (.prd)	35	Recipe block ID (0~15)																																					
Print Screen to File (256-color .bmp)	36	Screen number (1~7999)																																					
Print Screen to File (64K-color .bmp)	37	Screen number (1~7999)																																					
Save Logged Operations (.txt)	39	0																																					
Save Logged Data (.ldf)	40	Data logger ID (0~15)																																					
Take Picture (.bmp)	42	USB camera ID (0~3)																																					
Take Picture (.jpg)	43	USB camera ID (0~3)																																					
$P4$ (I)	The byte array that contains the specified filename or full pathname. The name must be a valid Windows pathname with ASCII characters only. The character string must be null terminated and each character occupies one byte. The maximum length of the string is 127. All the folders stated in the full pathname must already exist or the file operation will fail.																																						

## MKDIR

Format	$P1 = \text{MKDIR}(P2)$
Function	Creates a new directory with the specified name $P2$ and saves the result to $P1$ .
$P1$ (I)	The word to receive the completion code of the operation. If the completion code is 0, the operation succeeded; otherwise the operation failed.
$P2$ (I)	The byte array that contains the name of the new directory. The name must be a valid directory name with or without pathname and has only ASCII characters in it.



## OPEN\_FILE

Format	$P1 = \text{OPEN\_FILE}(P2, P3)$	Data Type	U												
Function	Creates or opens a file.														
$P1$ (I)	<p>The starting location of the memory block that is used as a File Information Block to receive the operation result. The structure of the File Information Block is shown below:</p> <table border="1"> <thead> <tr> <th>Data Item</th> <th>Data Type/Size</th> <th>Word No.</th> </tr> </thead> <tbody> <tr> <td>File handle</td> <td>32-bit Unsigned Integer</td> <td>0 and 1</td> </tr> <tr> <td>File size</td> <td>32 bit Unsigned Integer</td> <td>2 and 3</td> </tr> <tr> <td>Filename</td> <td>Byte array with 81 elements</td> <td>4 through 44</td> </tr> </tbody> </table> <p>The file handle is zero if the operation failed.  The file size is zero for a newly created file.  The filename is a null-terminated character string. The maximum allowable size is 80. It is set when the file is successfully opened.  A File Information Block requires 45 words.</p>			Data Item	Data Type/Size	Word No.	File handle	32-bit Unsigned Integer	0 and 1	File size	32 bit Unsigned Integer	2 and 3	Filename	Byte array with 81 elements	4 through 44
Data Item	Data Type/Size	Word No.													
File handle	32-bit Unsigned Integer	0 and 1													
File size	32 bit Unsigned Integer	2 and 3													
Filename	Byte array with 81 elements	4 through 44													
$P2$ (I)	The byte array that contains the filename or the full pathname of the file to be opened. The name is a null-terminated string and has only ASCII characters in it.														
$P3$ (I/C)	<p>Specifies the purpose of opening the file.</p> <table border="1"> <thead> <tr> <th>Purpose</th> <th>Value</th> </tr> </thead> <tbody> <tr> <td>Read</td> <td>0</td> </tr> <tr> <td>Write</td> <td>1</td> </tr> <tr> <td>Append</td> <td>3</td> </tr> </tbody> </table>			Purpose	Value	Read	0	Write	1	Append	3				
Purpose	Value														
Read	0														
Write	1														
Append	3														
Example 1	<pre><math>\\$U10 = \text{"test.txt"}</math> <math>\\$U100 = \text{OPEN\_FILE}(\\$U10, 0) /* Open the file "test.txt" for the read operation. The double word \\$100 will contain the file handle. The double word \\$102 will contain the file size. The byte array \\$104 will contain the filename. */</math></pre>														

## READ\_FILE

Format	$P1 = \text{READ\_FILE}(P2, P3, P4)$	Data Type	U
Function	Reads $P4$ bytes from file $P2$ to buffer $P3$ and saves the result in $P1$ .		
$P1$ (I)	The word to receive the number of bytes that were actually read. If the operation failed, the number is 65535 (0xFFFF).		
$P2$ (I)	The file handle of the file to be read.		
$P3$ (I)	The memory block to receive the data read from the file.		
$P4$ (I/C)	Number of bytes to be read from the file. The maximum you can specify is 32767(0x7FFF).		
Example 1	<pre><math>\\$U200 = \text{READ\_FILE}(\\$U100, \\$U150, 20) /* Read 20 bytes from the file specified by the file handle in \\$U100 and saves the data in the memory block starting from \\$U150. */</math></pre>		



## WRITE\_FILE

Format	$P1 = \text{WRITE\_FILE}(P2, P3, P4)$	Data Type	U
Function	Writes $P4$ bytes of data in $P3$ to file $P2$ and saves the completion code in $P1$ .		
$P1$ (I)	The word to receive the completion code of the operation. If the completion code is 0, the operation succeeded; Otherwise the operation failed.		
$P2$ (I)	The file handle of the file.		
$P3$ (I)	The memory block (or byte array) that stores the data to be written to the file.		
$P4$ (I/C)	Number of bytes to be written to the file.		
Example 1	$\$U200 = \text{WRITE\_FILE}(\$U100, \$U150, 30) /*$ Write 30 bytes of data stored in the memory block starting from $\$U150$ to the file specified by the file handle in $\$U100$ . $*/$		

## CLOSE\_FILE

Format	$P1 = \text{CLOSE\_FILE}(P2, P3)$	Data Type	U
Function	Closes an opened file $P2$ and saves the completion code in $P1$ .		
$P1$ (I)	The word to receive the completion code of the operation. If the completion code is 0, the operation succeeded; Otherwise the operation failed.		
$P2$ (I)	The file handle of the file to be closed.		
Example 1	$\$U200 = \text{CLOSE\_FILE}(\$U100) /*$ Close the file specified by the file handle in $\$U100$ . $*/$		

## DELETE\_FILE

Format	$P1 = \text{DELETE\_FILE}(P2)$	Data Type	U
Function	Deletes a file named $P2$ and saves the completion code in $P1$ .		
$P1$ (I)	The word to receive the completion code of the operation. If the completion code is 0, the operation succeeded; Otherwise the operation failed.		
$P2$ (I)	The byte array that contains the filename or the full pathname of the file to be deleted. The name is a null-terminated string and has only ASCII characters in it.		
Example 1	$\$U10 = \text{"test.txt"}$ $\$U200 = \text{DELETE\_FILE}(\$U10) /*$ Delete the file "test.txt". $*/$		

## RENAME\_FILE

Format	$P1 = \text{RENAME\_FILE}(P2, P3)$	Data Type	U
Function	Renames file $P2$ with new name $P3$ and saves the completion code in $P1$ .		
$P1$ (I)	The word to receive the completion code of the operation. If the completion code is 0, the operation succeeded; Otherwise the operation failed.		
$P2$ (I)	The byte array that contains the filename or the full pathname of the file to be renamed. The name is a null-terminated string and has only ASCII characters in it.		
$P3$ (I)	The byte array that contains the new filename. The name is a null-terminated string and has only ASCII characters in it.		
Example 1	$\$U10 = \text{"test.txt"}$ $\$U50 = \text{"new.txt"}$ $\$U200 = \text{RENAME\_FILE}(\$U10, \$U50) /*$ Rename the file "test.txt" to "new.txt". $*/$		





## GET\_VOL\_INFO

Format	$P1 = \text{GET\_VOL\_INFO}(P2,P3)$	Data Type	U															
<b>Function</b>	Gets the information of volume <i>P2</i> and saves the result in <i>P3</i> . The completion code is saved in <i>P1</i> .																	
<i>P1</i> (I)	The word to receive the completion code of the operation. If the completion code is 0, the operation succeeded; Otherwise the operation failed.																	
<i>P2</i> (I/C)	The drive ID. <table border="1"> <thead> <tr> <th>ID</th> <th>Drive</th> </tr> </thead> <tbody> <tr> <td>0</td> <td>Current drive</td> </tr> <tr> <td>3</td> <td>Drive C</td> </tr> <tr> <td>4</td> <td>Drive D</td> </tr> <tr> <td>5</td> <td>Drive E</td> </tr> </tbody> </table>			ID	Drive	0	Current drive	3	Drive C	4	Drive D	5	Drive E					
ID	Drive																	
0	Current drive																	
3	Drive C																	
4	Drive D																	
5	Drive E																	
<i>P3</i> (I)	<p>The starting location of the memory block that is used as a Volume Information Block to receive the operation result. The structure of the Volume Information Block is shown below:</p> <table border="1"> <thead> <tr> <th>Data Item</th> <th>Data Type/Size</th> <th>Word No.</th> </tr> </thead> <tbody> <tr> <td>Volume name</td> <td>Byte array with 32 elements</td> <td>0 through 15</td> </tr> <tr> <td>Volume size</td> <td>32-bit Unsigned Integer</td> <td>16 and 17</td> </tr> <tr> <td>Free size</td> <td>32-bit Unsigned Integer</td> <td>18 and 19</td> </tr> <tr> <td>Drive ID</td> <td>16-bit Unsigned Integer</td> <td>20</td> </tr> </tbody> </table> <p>The volume name is a null-terminated character string. The maximum allowable size is 31 characters.  Both the unit of volume size and the unit of free size are 1024 bytes.  A Volume Information Block requires 21 words.</p>			Data Item	Data Type/Size	Word No.	Volume name	Byte array with 32 elements	0 through 15	Volume size	32-bit Unsigned Integer	16 and 17	Free size	32-bit Unsigned Integer	18 and 19	Drive ID	16-bit Unsigned Integer	20
Data Item	Data Type/Size	Word No.																
Volume name	Byte array with 32 elements	0 through 15																
Volume size	32-bit Unsigned Integer	16 and 17																
Free size	32-bit Unsigned Integer	18 and 19																
Drive ID	16-bit Unsigned Integer	20																
<b>Example 1</b>	<pre><code>\$U100 = GET_VOL_INFO(0, \$U0) /* Get the volume information of the current drive. The volume name will be stored in \$U0 through \$U15. The size of the drive will be stored in \$U16 and \$U17. The free size of the drive will be stored in \$U18 and \$U19. The ID of the current drive will be stored in \$U20. */</code></pre>																	



## 14.4.16. Comparison

==

Format	$P1 = P2 == P3$	Data Type	U/S/UD/SD/F/B
Function	Sets bit $P1$ to 1 if $P2$ is equal to $P3$ , otherwise sets $P1$ to 0.		
$P1$ (I/E)	The bit location to save the result.		
$P2, P3$ (I/E/C/AE)	The operands.		
Example 1	$\$U3.3 = (\$U10 + \$U20) == 25.75$ (F)		

!=

Format	$P1 = P2 != P3$	Data Type	U/S/UD/SD/F/B
Function	Sets bit $P1$ to 1 if $P2$ is not equal to $P3$ , otherwise sets $P1$ to 0.		
$P1$ (I/E)	The bit location to save the result.		
$P2, P3$ (I/E/C/AE)	The operands.		
Example 1	$\$U3.3 = (\$U10 + \$U20) != -700$ (S)		

&gt;

Format	$P1 = P2 > P3$	Data Type	U/S/UD/SD/F
Function	Sets bit $P1$ to 1 if $P2$ is greater than $P3$ , otherwise sets $P1$ to 0.		
$P1$ (I/E)	The bit location to save the result.		
$P2, P3$ (I/E/C/AE)	The operands.		
Example 1	$\$U3.3 = (\$U10 + \$U20) > \$U30$ (UD)		

&gt;=

Format	$P1 = P2 >= P3$	Data Type	U/S/UD/SD/F
Function	Sets bit $P1$ to 1 if $P2$ is greater than or equal to $P3$ , otherwise sets $P1$ to 0.		
$P1$ (I/E)	The bit location to save the result.		
$P2, P3$ (I/E/C/AE)	The operands.		
Example 1	$\$U3.3 = (\$U10 + \$U20) >= 25.75$ (F)		

&lt;

Format	$P1 = P2 < P3$	Data Type	U/S/UD/SD/F
Function	Sets bit $P1$ to 1 if $P2$ is less than $P3$ , otherwise sets $P1$ to 0.		
$P1$ (I/E)	The bit location to save the result.		
$P2, P3$ (I/E/C/AE)	The operands.		
Example 1	$\$U3.3 = (\$U10 + \$U20) < 25.75$ (F)		

&lt;=

Format	$P1 = P2 <= P3$	Data Type	U/S/UD/SD/F
Function	Sets bit $P1$ to 1 if $P2$ is less than or equal to $P3$ , otherwise sets $P1$ to 0.		
$P1$ (I/E)	The bit location to save the result.		
$P2, P3$ (I/E/C/AE)	The operands.		
Example 1	$\$U3.3 = (\$U10 + \$U20) <= 25.75$ (F)		



## 14.4.17. String Operation

## STRCPY

<b>Format</b>	<b>STRCPY(<i>P1</i>, <i>P2</i>)</b>												
<b>Function</b>	Copies the string in <i>P2</i> to <i>P1</i> .												
<b><i>P1</i> (l)</b>	The byte array that receives a copy of the string in <i>P2</i> . The byte array must be large enough to hold the string and the null terminator.												
<b><i>P2</i> (l)</b>	The source, i.e. the byte array that contains the null-terminated string to be copied.												
<b>Example 1</b>	<p><b>\$U10 = "ABCDE"</b>  <b>STRCPY(\$U20, \$U10)</b>          After the command STRCPY is executed, the byte array \$U20 contains the string "ABCDE" and the memory content is like the following:</p> <table border="1"> <thead> <tr> <th>Word</th> <th>Low Byte</th> <th>High Byte</th> </tr> </thead> <tbody> <tr> <td>\$U20</td> <td>'A'</td> <td>'B'</td> </tr> <tr> <td>\$U21</td> <td>'C'</td> <td>'D'</td> </tr> <tr> <td>\$U22</td> <td>'E'</td> <td>0</td> </tr> </tbody> </table>	Word	Low Byte	High Byte	\$U20	'A'	'B'	\$U21	'C'	'D'	\$U22	'E'	0
Word	Low Byte	High Byte											
\$U20	'A'	'B'											
\$U21	'C'	'D'											
\$U22	'E'	0											
<b>Example 2</b>	<p><b>\$U10 = "12"</b>  <b>STRCPY(\$U20, \$U10)</b>          After the command STRCPY is executed, the byte array \$U20 contains the string "12" and the memory content is like the following:</p> <table border="1"> <thead> <tr> <th>Word</th> <th>Low Byte</th> <th>High Byte</th> </tr> </thead> <tbody> <tr> <td>\$U20</td> <td>'1'</td> <td>'2'</td> </tr> <tr> <td>\$U21</td> <td>0</td> <td>Undefined</td> </tr> </tbody> </table>	Word	Low Byte	High Byte	\$U20	'1'	'2'	\$U21	0	Undefined			
Word	Low Byte	High Byte											
\$U20	'1'	'2'											
\$U21	0	Undefined											

## STRCAT

<b>Format</b>	<b>STRCAT(<i>P1</i>, <i>P2</i>)</b>
<b>Function</b>	Appends string in <i>P2</i> to string in <i>P1</i> .
<b><i>P1</i> (l)</b>	The byte array that contains a null-terminated string to which the command appends <i>P2</i> . The byte array must be large enough to hold both strings and the null terminator.
<b><i>P2</i> (l)</b>	The byte array that contains a null-terminated string to be appended to the string in <i>P1</i> .
<b>Example 1</b>	<p><b>\$U10 = "ABC"</b>  <b>\$U20 = "12345"</b>  <b>STRCAT(\$U10, \$U20) /* After this command is executed, the byte array \$U10 contains "ABC12345" */</b></p>
<b>Example 2</b>	<p><b>\$U100 = "C:\MyFolder\"</b>  <b>\$U130 = "Test"</b>  <b>\$U140 = ".txt"</b>  <b>STRCAT(\$U100, \$U130)</b>  <b>STRCAT(\$U100, \$U140) /* After this command is executed, the byte array \$U100 contains "C:\MyFolder\Test.txt" */</b></p>



## STRLEN

<b>Format</b>	<b><math>P1 = \text{STRLEN}(P2)</math></b>
<b>Function</b>	Gets the length of string <b>P2</b> and saves the result in <b>P1</b> .
<b>P1 (I)</b>	The word to receive the result.
<b>P2 (I)</b>	The byte array that stores the null-terminated string.
<b>Example 1</b>	$\$U10 = \text{"ABC"}$ $\$U20 = \text{STRLEN}(\$U10)$ /* After this command is executed, the value of \$U20 is 3. */

## NUM2STR

<b>Format</b>	<b><math>P1 = \text{NUM2STR}(P2, P3)</math></b>	<b>Data Type</b>	<b>U/UD</b>
<b>Function</b>	Converts the number in <b>P2</b> to a string with <b>P3</b> characters and saves the result in <b>P1</b> .		
<b>P1 (I)</b>	The byte array that stores the result.		
<b>P2 (I/C)</b>	The number or the location that holds the number to be converted.		
<b>P3 (I/C)</b>	Specifies the exact number of characters that the result should have. If the number of digits of <b>P2</b> is less than <b>P3</b> , the result is padded on the left with zeros. If the number of digits of <b>P2</b> exceeds <b>P3</b> , the higher digits are truncated. If <b>P3</b> is 0, there is no limitation on the length of the result.		
<b>Example 1</b>	$\$U120 = 123$ $\$U100 = \text{NUM2STR}(\$U120, 0) (U)$ /* After this command is executed, the byte array \$U100 contains "123". */		
<b>Example 2</b>	$\$U120 = 1234567 (UD)$ $\$U100 = \text{NUM2STR}(\$U120, 10) (UD)$ /* After this command is executed, the byte array \$U100 contains "0001234567". */		
<b>Example 3</b>	$\$U120 = 1234567 (UD)$ $\$U100 = \text{NUM2STR}(\$U120, 5) (UD)$ /* After this command is executed, the byte array \$U100 contains "34567". */		

## TIME2STR

<b>Format</b>	<b><math>P1 = \text{TIME2STR}(P2)</math></b>	<b>Data Type</b>	<b>U</b>
<b>Function</b>	Converts the current system time to a string using the format specified by <b>P2</b> and saves the result in <b>P1</b> .		
<b>P1 (I)</b>	The byte array that stores the result.		
<b>P2 (I/C)</b>	Specifies the desired conversion format.		
	<b>Format</b>	<b>P2 Value</b>	<b>Remark</b>
	hhmmss	0	hh: hour(00~23); mm: minute(00~59); ss: second(00~59)
	hhmm	1	hh, mm: same as above
<b>Example 1</b>	$\$U10 = \text{TIME2STR}(0)$ /* Assume that the current system time is 12:30:59. After this command is executed, the byte array \$U10 contains "123059". */		



## DATE2STR

Format	$P1 = \text{DATE2STR}(P2)$	Data Type	U
<b>Function</b>	Converts the current system date to a string using the format specified by <b>P2</b> and saves the result in <b>P1</b> .		
<b>P1 (I)</b>	The byte array that stores the result.		
<b>P2 (I/C)</b>	Specifies the desired conversion format.		
	Format	P2 Value	Remark
	YYMMDD	0	YY: year (00~99); MM: month(01~12); DD: day(01~31)
	YYMM	1	YY, MM: same as above
	YYMMMDD	2	YY: year (00~99); MMM: month(JAN~DEC); DD: day(01~31)
YYMMM	3	YY, MMM: same as above	
<b>Example 1</b>	$\$U10 = \text{DATE2STR}(0)$ /* Assume that the current system date is December 7, 2008. After this command is executed, the byte array \$U10 contains "081207". */		
<b>Example 2</b>	$\$U20 = \text{DATE2STR}(3)$ /* Assume that the current system date is December 31, 2008. After this command is executed, the byte array \$U20 contains "08DEC". */		

## TD2STR

Format	$P1 = \text{TD2STR}(P2)$	Data Type	U
<b>Function</b>	Converts the current system time and date to a string using the format specified by <b>P2</b> and saves the result in <b>P1</b> .		
<b>P1 (I)</b>	The byte array that stores the result.		
<b>P2 (I/C)</b>	Specifies the desired conversion format.		
	Format	P2 Value	Remark
	YYMMDD_hhmmss	0	YY: year (00~99); MM: month(01~12); DD: day(01~31) hh: hour(00~23); mm: minute(00~59); ss: second(00~59)
	YYMMMDD_hhmmss	1	YY, DD, hh, mm, ss: same as above MMM: month(JAN~DEC)
	YYMMDD_hhmm	2	YY, DD, hh, mm: same as above; MM: month(01~12)
YYMMMDD_hhmm	3	YY, DD, hh, mm: same as above; MMM: month(JAN~DEC)	
<b>Example 1</b>	$\$U10 = \text{TD2STR}(0)$ /* Assume that the current system date is December 7, 2008 and the current system time is 15:18:30. After this command is executed, the byte array \$U10 contains "081207_151830". */		
<b>Example 2</b>	$\$U20 = \text{TD2STR}(3)$ /* Assume that the current system date is December 31, 2008 and the current system time is 13:30:00. After this command is executed, the byte array \$U20 contains "08DEC31_1330". */		



## I2A

Format	$P1 = I2A(P2, P3)$	Data Type	U/S/UD/SD
<b>Function</b>	Converts the integer number in <b>P2</b> to a string and saves the result in <b>P1</b> . The string is generated according to the format specified by <b>P3</b> and <b>P4</b> .		
<b>P1</b> (I)	The byte array that stores the result. The result is a null terminated string.		
<b>P2</b> (I/C)	The integer number or the location that holds the integer number to be converted.		
<b>P3</b> (I/C)	Specifies the maximum number of digits the string can have.		
<b>P4</b> (I/C)	Specifies where to insert a decimal point in the string. A decimal point is inserted to the left of the nth digit when <b>P4</b> is n. No decimal point is inserted when <b>P4</b> is 0.		
<b>Example 1</b>	$\$U120 = 123$ $\$U100 = I2A(\$U120, 5, 0) /*$ After this command is executed, the byte array \$U100 contains "123". */		
<b>Example 2</b>	$\$U120 = 1234567$ (UD) $\$U100 = I2A(\$U120, 6, 2)$ (UD) /* After this command is executed, the byte array \$U100 contains "2345.67". */		
<b>Example 3</b>	$\$U120 = -12345$ (S) $\$U100 = I2A(\$U120, 5, 1)$ (UD) /* After this command is executed, the byte array \$U100 contains "-1234.5". */		

## A2I

Format	$P1 = A2I(P2, P3, P4)$	Data Type	U/S/UD/SD
<b>Function</b>	Converts the string <b>P2</b> to an integer value and saves the result in <b>P1</b> .		
<b>P1</b> (I)	The location that stores the result. The result is 0 when there is any conversion error.		
<b>P2</b> (I)	The byte array that holds the string to be converted.		
<b>P3</b> (I/C)	Specifies the length of the string. It is allowed to specify 0 for <b>P3</b> . When <b>P3</b> is 0, the string must be a null terminated string.		
<b>P4</b> (I/C)	Specifies how many fractional digits in the string are to be converted.		
<b>Example 1</b>	$\$U120 = "123"$ $\$U100 = A2I(\$U120, 0, 0) /*$ After this command is executed, the value in word \$U100 is 123. */		
<b>Example 2</b>	$\$U120 = "1234567"$ $\$U100 = A2I(\$U120, 6, 0)$ (UD) /* After this command is executed, the value in double word \$U100 is 123456. */		
<b>Example 3</b>	$\$U120 = "-123.45"$ $\$U100 = A2I(\$U120, 0, 2)$ (S) /* After this command is executed, the value in word \$U100 is -12345. */		



## F2A

Format	$P1 = F2A(P2, P3)$	Data Type	F
Function	Converts the floating point number in <b>P2</b> to a string and saves the result in <b>P1</b> . The string is generated according to the format specified by <b>P3</b> and <b>P4</b> .		
<b>P1</b> (I)	The byte array that stores the result. The result is a null terminated string.		
<b>P2</b> (I/C)	The floating point number or the location that holds the floating point number to be converted.		
<b>P3</b> (I/C)	Specifies the number of integral digits the string can have.		
<b>P4</b> (I/C)	Specifies the number of fractional digits the string can have.		
Example 1	$\$U120 = 123.45$ (F) $\$U100 = F2A(\$U120, 5, 2)$ /* After this command is executed, the byte array \$U100 contains "123.45". */		
Example 2	$\$U120 = 1234$ (F) $\$U100 = F2A(\$U120, 6, 2)$ (UD) /* After this command is executed, the byte array \$U100 contains "1234.00". */		
Example 3	$\$U120 = -1234.5$ (S) $\$U100 = F2A(\$U120, 5, 1)$ (UD) /* After this command is executed, the byte array \$U100 contains "-1234.5". */		

## A2F

Format	$P1 = A2F(P2, P3)$	Data Type	F
Function	Converts the string <b>P2</b> to a floating point number and saves the result in <b>P1</b> .		
<b>P1</b> (I)	The location that stores the result. The result is 0 when there is any conversion error.		
<b>P2</b> (I)	The byte array that holds the string to be converted.		
<b>P3</b> (I/C)	Specifies the length of the string. It is allowed to specify 0 for <b>P3</b> . When <b>P3</b> is 0, the string must be a null terminated string.		
Example 1	$\$U120 = "123.4"$ $\$U100 = A2F(\$U120, 0)$ /*The value of the floating point number in double word \$U100 is 123.4. */		
Example 2	$\$U120 = "1234567"$ $\$U100 = A2F(\$U120, 6)$ (UD) /* The value of the floating point number in double word \$U100 is 123456. */		
Example 3	$\$U120 = "-123.45"$ $\$U100 = A2F(\$U120, 0)$ (S) /* The value of the floating point number in double word \$U100 is -123.45. */		



### 14.4.18. Run Operation

#### RUN

<b>Format</b>	<b>RUN(P1)</b>	<b>Data Type</b>	-
<b>Function</b>	Runs the executable <b>P1</b> which is on the same PC. This command is available for PM SCADA only.		
<b>P1 (I/A)</b>	The name of the executable to be run.		
<b>Example 1</b>	RUN "ABC.exe" /* Run the program ABC */		
<b>Example 2</b>	<pre>\$U10 = "XYZ.bat" RUN \$U10 /* Run the batch file XYZ */</pre>		

#### RUNW

<b>Format</b>	<b>P1 = RUNW(P2)</b>	<b>Data Type</b>	-
<b>Function</b>	Runs the executable <b>P2</b> which is on the same PC and saves the result in <b>P1</b> . Note that the macro command following this one will not be executed until the program is closed. This command is available for PM SCADA only.		
<b>P1 (I)</b>	The word to receive the result.		
<b>P2 (I/A)</b>	The name of the executable to be run.		
<b>Example 1</b>	<pre>\$U10 = RUNW "ABC.exe" /* Run the program ABC and use \$U10 to get the result. */ IF \$U10 == 0 /* If the result is 0 then run the batch file XYZ. */     \$U20 = "XYZ.bat"     \$U11 = RUNW \$U20 /* Run the batch file XYZ. */ ENDIF</pre>		





## 14.4.19. Print Operation

## PRINT

Format	$P1 = \text{PRINT}(P2,P3)$	Data Type	U												
<b>Function</b>	Sends $P3$ bytes of data stored in byte array $P2$ to the printer and saves the completion code in $P1$ .														
$P1$ (I)	<p>The word to receive the completion code of the operation. The following table describes the meanings of the completion codes.</p> <table border="1"> <thead> <tr> <th>Code</th> <th>Description</th> </tr> </thead> <tbody> <tr> <td>0</td> <td>Succeeded</td> </tr> <tr> <td>1</td> <td>Printer not ready</td> </tr> <tr> <td>3</td> <td>System error</td> </tr> <tr> <td>4</td> <td>Printer busy</td> </tr> <tr> <td>7</td> <td>No printer specified</td> </tr> </tbody> </table>			Code	Description	0	Succeeded	1	Printer not ready	3	System error	4	Printer busy	7	No printer specified
Code	Description														
0	Succeeded														
1	Printer not ready														
3	System error														
4	Printer busy														
7	No printer specified														
$P2$ (I)	The starting location of the byte array that stores the data to be sent to the printer.														
$P3$ (I/C)	The length in byte of the data to be sent to the printer.														
<b>Example 1</b>	<pre> \$U10 = "This is a test." \$U20 = PRINT(\$U10, 15) /* Send the string "This is a test." to the printer. */ \$U10 = 10 \$U20 = PRINT(\$U10, 1) /* Send the line-feed character to the printer */ \$U10 = 12 \$U20 = PRINT(\$U10, 1) /* Send the form-feed character to the printer */ </pre>														
<b>Example 2</b>	<pre> \$U10 = 0x401b /* ESC, '@' */ \$U20 = PRINT(\$U10, 2) /* Send the initialization command to the EPSON printer */ </pre>														

## PRINT\_SCREEN

Format	$P1 = \text{PRINT\_SCREEN}(P2,P3)$	Data Type	U																		
<b>Function</b>	Prints screen $P2$ and saves the result in $P1$ .																				
$P1$ (I)	<p>The word to receive the completion code of the operation. The following table describes the meanings of the completion codes.</p> <table border="1"> <thead> <tr> <th>Code</th> <th>Description</th> </tr> </thead> <tbody> <tr> <td>0</td> <td>Succeeded</td> </tr> <tr> <td>1</td> <td>Printer not ready</td> </tr> <tr> <td>2</td> <td>Invalid screen number</td> </tr> <tr> <td>3</td> <td>System error</td> </tr> <tr> <td>4</td> <td>Printer busy</td> </tr> <tr> <td>5</td> <td>System busy</td> </tr> <tr> <td>6</td> <td>Improper use of this command (See Note)</td> </tr> <tr> <td>7</td> <td>No printer specified</td> </tr> </tbody> </table> <p><b>Note:</b> This command can only be used in the following types of macros: Main Macro, Event Macro, Time Macro, and Cycle Macro.</p>			Code	Description	0	Succeeded	1	Printer not ready	2	Invalid screen number	3	System error	4	Printer busy	5	System busy	6	Improper use of this command (See Note)	7	No printer specified
Code	Description																				
0	Succeeded																				
1	Printer not ready																				
2	Invalid screen number																				
3	System error																				
4	Printer busy																				
5	System busy																				
6	Improper use of this command (See Note)																				
7	No printer specified																				
$P2$ (I/C)	The number of the screen to be printed. The printed area is specified in the Screen Properties dialog box.																				
$P3$ (I/C)	Reserved for future use. Must be 0.																				
<b>Example 1</b>	<pre> \$U0 = PRINT_SCREEN(28, 0) /* Print screen #28*/ </pre>																				

